

## **1. Introduction**

The very low energy demand of passive houses, which has been proven by measurement, is in the range of the target of the Nearly-Zero-Energy directive. Hence, the foundation of a development is already laid today which will be introduced in Europe in 9 years (the recast Energy Performance of Buildings Directive, EPBD, Directive 2010/31/EU). Due to the very high level of thermal insulation and the resulting very low heating demand and heating load, passive houses show a well balanced load duration curve. The domestic hot water demand can be covered with a high fraction by solar energy. However, solar heating of passive houses is under most circumstances poorly effective as the heating demand is confined to few months in main winter.

The heat supply of passive houses is frequently realized with heat pumps – in particular in form of compact units (heating, domestic hot water, mechanical ventilation with heat recovery in one device). Several types of these compact units are available. In the meantime also units with higher power (up to 22 KW) are available for very large single family houses, low energy houses or renovated houses where passive house standard could not be achieved (Meyer 2010). Those systems often do not use the exhaust air as heat source but ambient air or brine and integrate low temperature hydraulic heating circuits additionally or alternatively to the typical air heating system. A further market penetration of these systems is mainly slowed down due to the still high costs of these systems. In particular in multi-family houses the application of compact units is hardly economic compared to centralized solutions (e.g. PH Pantuceckgasse).

## **2. Enhanced Heat Supply for Passive Houses**

The heat supply of passive houses plays a minor role compared to existing buildings. Nevertheless, an energy efficient solution should be aimed at also for passive houses. Compared to conventional buildings where the heating demand prevails, the share of domestic hot water is in the range of 50 % and more in single-family passive houses. Accordingly, for passive houses not only heat pumps with lower power are required but heat pumps, which are adjusted to the high share of domestic hot water preparation with high condensation temperatures compared to heating. Thus the performance factors could be increased and at the same time the costs could be significantly decreased. Air to air heat pumps, e.g. as split heat pump, are a cost efficient alternative to the compact unit however feature rather poor performance factors. An increase of the performance factor can be obtained by a reduction of the sink temperature by means of a low temperature heating (floor heating, thermo active building systems) and by using the ground as heat source with more moderate and more balanced temperatures compared to ambient.

Vertical ground heat exchangers that are widely used with ground sourced heat pumps represent a good choice from the technical point of view. However, with costs of considerably more than 5000 € per borehole they are generally hardly economic for single family passive houses.

Several different types of horizontal ground heat exchanger are available: e.g. horizontal collectors (harp, meander, capillary pipe, bifilar), trench or basket collectors (compact absorber, helix) and different types of building integrated collectors. Piping length is typically limited to 100 m (rarely 120 m or 150 m) due to practical reasons on the one hand (length of pipe on coil) and on the other hand to keep the pressure loss in limits. For brine-air heat exchanger which succeeded in the market for air preheating, frequently a coil of 80 m to 100 m is laid two times around the perimeter of the house. Larger ground heat exchangers are installed in several parallel loops. All types have already been realized but have been investigated scientifically only in different degree of detail, e.g. Cauret et al. (2009). The costs of these systems are generally also still too high.

A horizontal ground heat exchanger that is installed in the blinding layer of the building represents a new cost effective concept. This system has already been realized in several passive houses and was investigated

in detail in one house (Peper et al. 2010). The horizontal ground heat exchanger is thermally decoupled from the building by slab perimeter insulation, see Fig. 1.

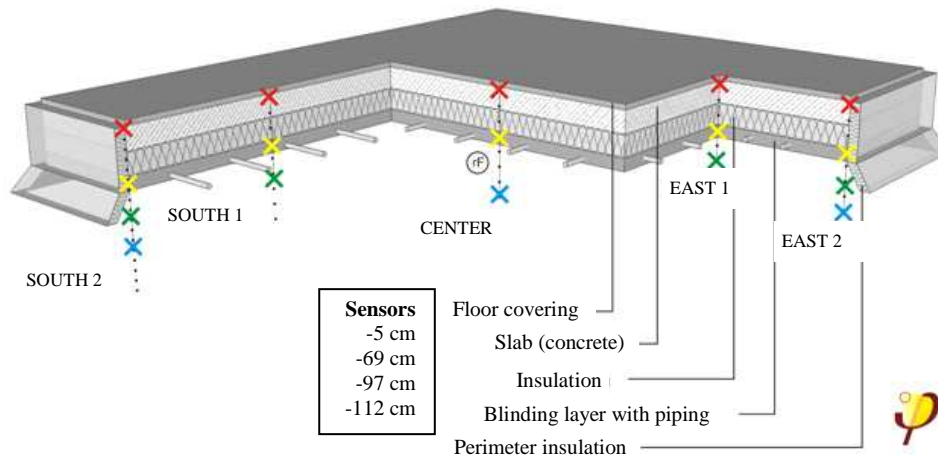
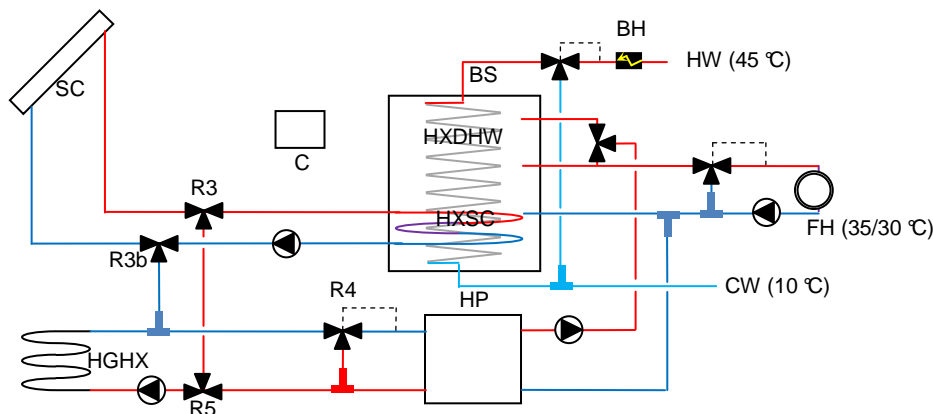

**Fig. 1: Sketch of the horizontal ground heat exchanger in blinding layer with insulation skirt as well as position of temperature sensors below the building**

Compared to systems with vertical ground heat exchanger this concept is significantly more cost effective. However, as frost protection of the slab has to be guaranteed it works only with restrictions. Freezing of the ground can be prevented either by limiting the inlet temperature and thus the power of the heat pump or the operation time of the heat pump. Then a additional heat source would be required. Or the ground temperature can be increased by charging the soil with solar energy. A prerequisite for this concept is a highly insulated building envelope which ensures an extremely low heating consumption and the floor slab of the building must be insulated to a very high standard.

### 3. Solar Heat Pump Concept, Example SFH Trykowski

The free-standing single-family house (SFH) near Bamberg being built according to the Passive House Standard (152 m<sup>2</sup> treated floor area) is equipped with solar heating system with a size of 10 m<sup>2</sup> and combined storage tank for supplying hot water and heating. The surplus heat is charged into the ground under the house by means of the cost-efficient ground heat exchanger installed in the blinding layer below the building. A small insulation skirt with a depth of 300 mm reduces the losses of the “heat reservoir”. This heat can be discharged from the ground heat exchanger if required by means of a brine heat pump. If the temperature level in the combined heat storage tank is insufficient, the water is reheated using an electrical continuous flow heater. Hence, with regard to non-renewable energy sources, the supply in this building is mono-fuel. The components of the energy system (see hydraulic scheme in Fig. 2) and their characteristics are listed in table 1.



**Fig. 2: Hydraulic scheme with solar thermal collectors (SC), ground heat exchanger (HGHX), heat pump (HP), buffer store (BS) with solar (HXSC)- and domestic hot water heat exchanger (HXDHW), direct electric backup-heater (BH), three-way-valves (R) as well as cold water (CW), hot water (HW), floor heating (FH) and controller (C)**

Tab. 1: Components of the energy system, SFH Trykowski

Component	Details
Ventilation	mechanical ventilation with heat recovery ( $\eta_{\text{eff}} = 87\%$ ) with additional ground heat exchanger
Solar	10.2 m <sup>2</sup> (brutto) roof integrated flat plate collectors (Trisol Solar GmbH)
Hot water store	750 litre buffer store (combi) with immersed tube-heat exchangers (solar and dhw)
Heat pump	brine/water P = 4.8 kW (Viessmann Vitocal 300, Type BW 104), brine temperature: max. 25 °C, min -5 °C
Ground heat exchanger	4 x 75 m PE (20 x 2 mm) = 3 m/m <sup>2</sup> below basement (and perimeter insulation) in blinding layer
Heating system	floor heating (in 8 circuits) with thermo-electric valve actuators, 7 room temperature controllers (35 °C flow)
Domestic hot water	Immersed tube heat exchanger, electric flow type backup heater

#### 4. Monitoring Results

The detailed investigation of this building presented in Peper et al. (2010) has shown that this Passive House functions properly. The slightly higher heating consumption of 23 kWh/(m<sup>2</sup> a) can be partly explained with the fact that in spite of solar heat injection the ground under the floor slab is colder in winter than it would be without active heat withdrawal. This leads to an increased flow of heat into the soil (about 2 kWh/(m<sup>2</sup>a)) in spite of 300 mm of floor slab insulation. The indoor temperature in winter is apparently higher than the set temperature of the PHPP balance which is 20 °C (effect: 2.5 kWh/(m<sup>2</sup> a) per Kelvin of temperature increase). In addition, the heating consumption is increased compared to the calculations as at present the house is occupied by only two persons leading to lower specific internal heat gains (the building was planned as a two-family house with 152 m<sup>2</sup> treated floor area).

Only moderate temperatures of a maximum of 22 °C were measured in the ground below the building with almost no horizontal deviations, see Fig. 3. As could be shown by simulation (Ochs 2010), a larger solar collector area would only lead to slightly higher temperatures under the house, due to the comparatively rapid dissipation of heat in the ground. It is apparent that seasonal storage of surplus solar heat under the floor slab for the given dimensions of a single-family house is effective only to a limited degree. Hence, it is rather a system with solar regeneration of the ground as the source for the heat pump than seasonal storage.

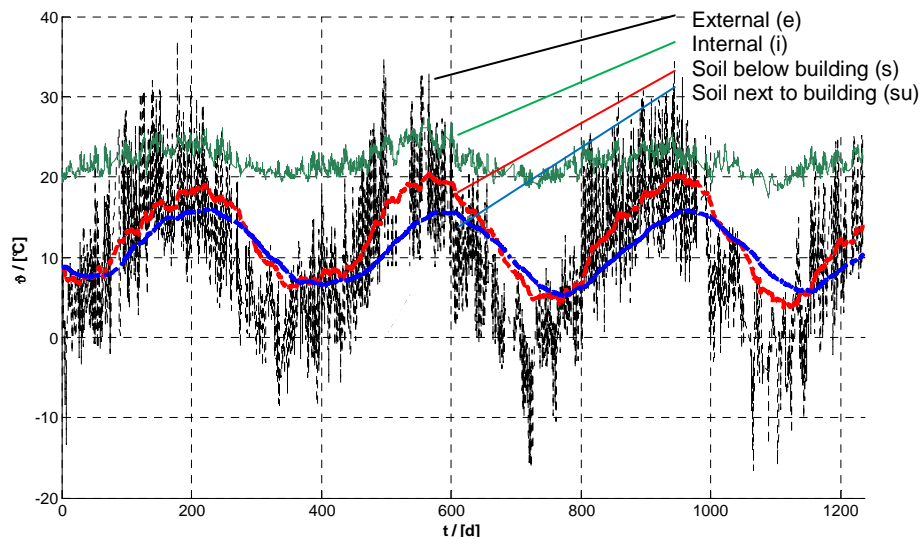

Fig. 3: Course of ambient temperature (e) internal temperature (i) ground temperature below the building (s) and undisturbed ground temperature (su)

The annual performance factor heat pump (without auxiliary units such as circulation pumps) is in the range of 3. The reasons for these rather average values are:

- individual components that have not been optimally adapted,
- the relatively low source temperature (soil) during the course of the winter in spite of solar charging, and
- reaching the limit of the system at the end of winter due to lower temperature limit of the heat pump to prevent freezing of the soil (The resulting pulsing and the rather low brine temperature of the heat pump lead to very poor performance factor, however, the residents were always supplied with sufficient heat; the domestic hot water was heated mainly by means of direct electricity in this periods).

The brine pump was found to have a low energy efficiency level and due to its over-dimensioning it could only be operated at a poor operating point. Hence, here lies a great potential for optimisation. In contrast, the solar heating system achieves good or excellent specific solar gains with  $485 \text{ kWh}/(\text{m}^2_{\text{Collector}} \text{ a})$ .

In terms of primary energy, with almost  $44 \text{ kWh}/(\text{m}^2 \text{ a})$  the system achieves a result similar to that in Passive Houses with standard heat heating systems (based on energy reference area). This appears to be disappointing with regard to the increased technical and financial effort compared with the reference systems used in Passive Houses. However, with an improvement of the efficiency of the brine circulation pump, the primary energy value of this system can be decreased to about  $37 \text{ kWh}/(\text{m}^2 \text{ a})$ . According to the findings of the simulation, if the further optimisation potential of 5 % to 15 % is realised (especially by reducing the pulsing of the heat pump), primary energy values of about  $32 \text{ kWh}/(\text{m}^2 \text{ a})$  may be achieved hence, it would be possible to achieve quite good specific primary energy values with systems of this kind.

## 5. Modeling and Simulation

If at the same time efficient, robust and cost-effective systems are aimed at, an adequate dimensioning of components in conjunction with an intelligent control concept is required. Sufficiently accurate and at the same time sufficiently fast models, which are feasible for system simulations are required to determine the potential of the different concepts and control strategies.

The literature of vertical ground heat exchanger models is extensive; see e.g. Yang et al. (2000) for more details. However, there are few validated models for horizontal ground collectors. Previous studies are limited mostly to very simple models also in case of complex ground collectors e.g. Cauret et al. (2009) and Chiasson et al. (2010). For air-to-ground heat exchanger models have been developed, which are mostly limited to single tubes Hollmueller et al. (2005), Feist et al. (1999).

Due to the shallow depth (usually well below 5 m) in contrast to borehole heat exchangers horizontal ground heat exchangers are strongly influenced by weather conditions such as variation of the ambient temperature, solar radiation and long-wave radiation as well as rain and snow (including thawing). In addition, freezing of the soil next to the pipes may play an important role. Depending on the type of soil in addition to the influence of groundwater diffusive moisture transport and the influence of moisture-dependent thermal conductivity of the soil may be of importance. In the case of air ground heat exchangers, heat transfer due to phase change (evaporation/condensation) has to be taken into account. Since the modeling effort is significant, convergence is rather poor and last but not least, usually the knowledge of the relevant parameters for the mechanisms mentioned above is poor, only heat conduction in the ground is taken into account in most models.

Many of the commonly used ground heat exchangers have relatively complex geometries and must be consequently depicted in 3D, if all relevant effects shall be considered. In particular trench or basket collectors and construction integrated systems such as ground absorbers with additional perimeter insulation such as in the case of the presented ground heat exchanger simplifications are hardly possible at the first glance. In case of symmetries the model can be simplified more easily. It is not always necessary to map the entire collector. For large collector areas, when edge effects play a minor role, the 2D or 3D simulation domain may only include a part of the ground heat exchanger considering symmetries, see Figure 4. For more complex geometries FE programs such as Comsol have to be used. Simplified models are required for fast (multi-)annual simulations even with today's computing power in particular if parametric studies, optimization or parameter identification (inverse simulation) are conducted. In such simplified 1D models the ground heat exchanger is considered as a semi-isothermal heat exchanger with an effective heat transfer capability (UA) depending on the pipe geometry and distance, see Fig. 5.

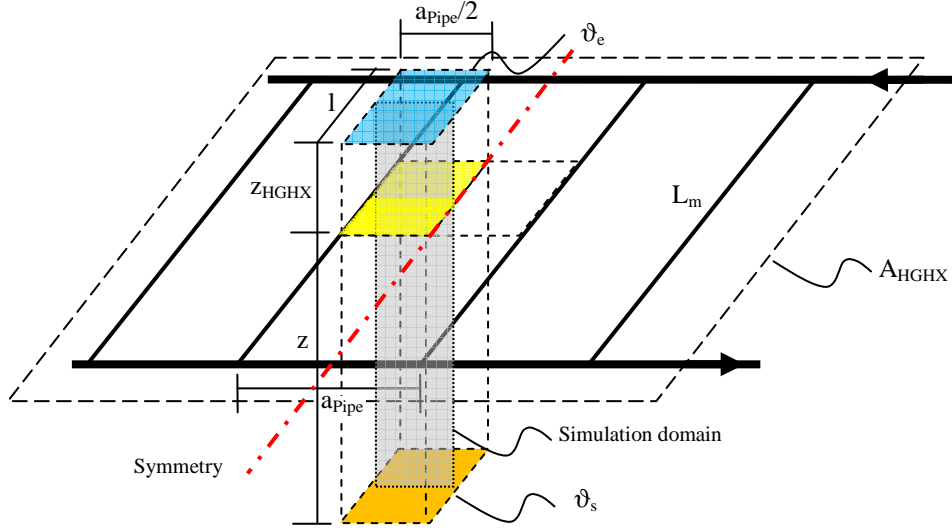

Fig. 4: Simulation domain for 2D or 3D simulation of heat transport in the ground with depth of the pipes  $z_{\text{HGHX}}$ , pipe spacing  $a_{\text{pipe}}$ , length of pipe  $L_m$  and area of ground heat exchanger  $A_{\text{HGHX}}$

$$\vartheta_1'' = \vartheta_1' - (\vartheta_1' - \vartheta_{\text{soil}}) \cdot \left(1 - e^{-\frac{UA}{C}}\right) \quad (\text{eq. 1})$$

$$\dot{Q} = \dot{C} \cdot (\vartheta_1'' - \vartheta_1') = UA \cdot \Delta \vartheta_{\log} \quad (\text{eq. 2})$$

The heat flow is the product of the heat capacity flow  $C = \dot{c} \dot{m}$  and the difference of inlet and outlet temperatures  $\vartheta_1'$  and  $\vartheta_1''$ .

and is equal to the product of the heat transfer capability  $UA$  and the logarithmic temperature difference:

$$\Delta \vartheta_{\log} = \frac{(\vartheta_1' - \vartheta_{\text{soil}}) - (\vartheta_1'' - \vartheta_{\text{soil}})}{\ln \left( \frac{\vartheta_1' - \vartheta_{\text{soil}}}{\vartheta_1'' - \vartheta_{\text{soil}}} \right)} \quad (\text{eq. 3})$$

If the wall of the tube is not depicted, i.e. the radius  $r = 0$  is on the outside diameter of the tube, the heat transfer capability  $UA$  has to be referred to the outer diameter considering the thickness  $0.5 \cdot (d_e - d_i)$  and thermal conductivity  $\lambda_p$  of the pipe:

$$A = \pi \cdot d_e \cdot L \quad (\text{eq. 4})$$

$$U = \left( \frac{d_e}{d_i \cdot h_i} + \frac{d_e}{2} \cdot \ln \frac{d_e}{d_i} \cdot \frac{1}{\lambda_p} \right)^{-1} \quad (\text{eq. 5})$$

The internal heat transfer coefficient is a function of the pipe geometry, the operation conditions and the fluid properties and is calculated at each time step

$$h_i = f(d_p, L_p, \dot{m}, \vartheta_m, \lambda_{\text{fluid}}, \rho_{\text{fluid}}, c_{\text{fluid}}, V_{\text{fluid}}) \quad (\text{eq. 6})$$

The theoretical upper bound for the heat transfer surface is twice the collector area. Such a model is sufficiently precise for not too large pipe distances. For large pipe spacing ( $\sim 1$  m) or single tubes the heat transfer capability ( $UA$ ) is overestimated with such a model. In that case a radial symmetric model is preferable.

Cartesian coordinates (1D model)

$$\frac{\partial \vartheta_i}{\partial t} = \frac{1}{\rho \cdot c} \cdot \frac{\lambda}{\Delta z^2} \cdot (\vartheta_{j-1} - 2 \cdot \vartheta_j + \vartheta_{j+1}) \quad (\text{eq. 7})$$

Cylindrical coordinates (radial symmetric model)

$$\frac{\partial \vartheta_i}{\partial t} = \frac{1}{\rho \cdot c} \cdot \frac{\lambda}{\Delta r^2} \cdot \left( \left( 1 - \frac{\Delta r}{2 \cdot r_j} \right) \cdot \vartheta_{j-1} \cdot \vartheta_{j+1} - 2 \cdot \vartheta_j + \left( 1 + \frac{\Delta r}{2 \cdot r_j} \right) \right) \quad (\text{eq. 8})$$

In the relevant range of the number of transfer unit ( $NTU = C/UA < 2$ ) of brine or water ground heat exchanger and common values of the thermal conductivity of the soil (1 to 3 W/(m K)) the error of using only one node in flow direction compared to a model with multiple nodes is below 5% in most cases less than 2%.

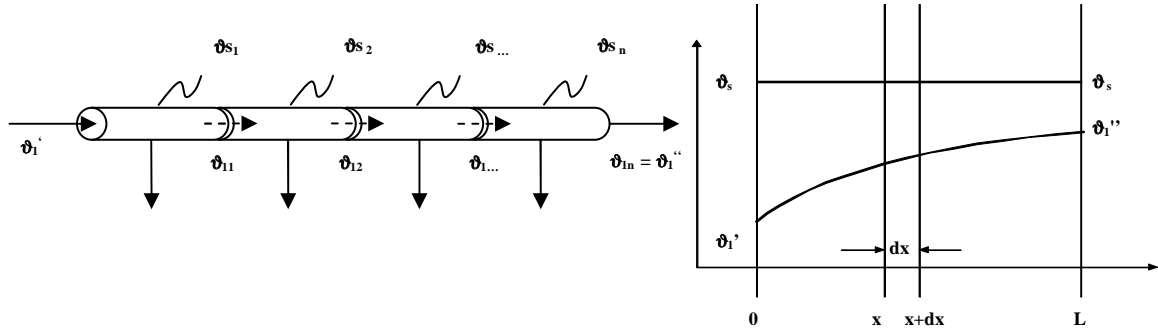

Fig. 5: Flow in pipe with several segments (nodes n) and temperature profile of semi-isothermal heat exchanger with inlet temperature  $\vartheta_1'$  outlet temperature  $\vartheta_1''$  soil temperature as a function of time ( $\vartheta_s=f(t)$ ) and constant with respect to the pipe length L

A 1D model and a radial symmetric model of a ground heat exchanger have been developed on the basis of the PDE-Solver *pdepe* in Matlab. Furthermore, for both types models were implemented as level-2-s-functions for Matlab/Simulink (Matlab2010) for the application in system simulations. The model validation was performed with measured data for the ground heat exchanger in the blinding layer of the system described above Ochs 2010, Ochs et al. (2011). Furthermore, both models were cross-validated against other programs such as a *Comsol* model and a 2D ground heat exchanger model according to Glück. The comparison of the 1D-model and the radial symmetric model with a symmetric 2D-model is shown in Fig. 6 as a function of the pipe spacing (d) or assuming a constant collector area of 100 m<sup>2</sup> for various pipe lengths (L = 1000, 400, 200, 100, 50 and 25 m).

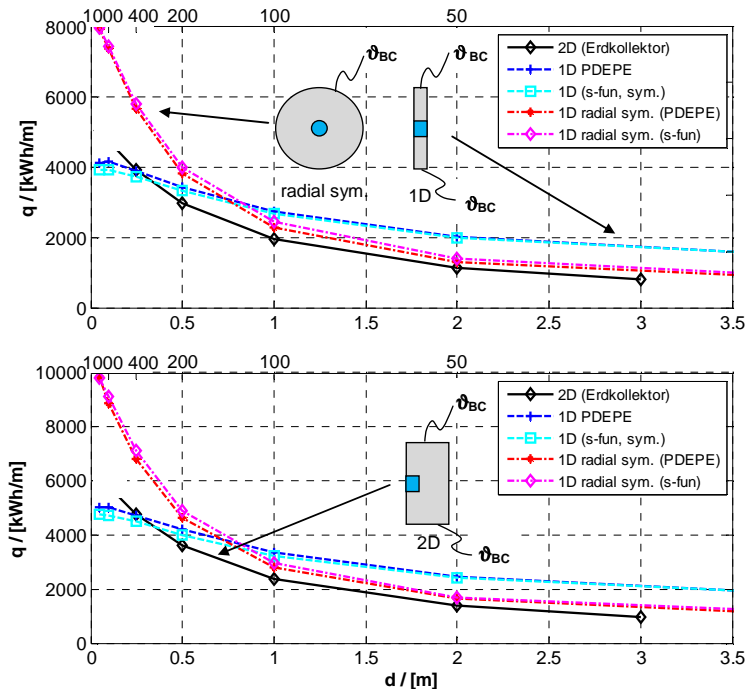
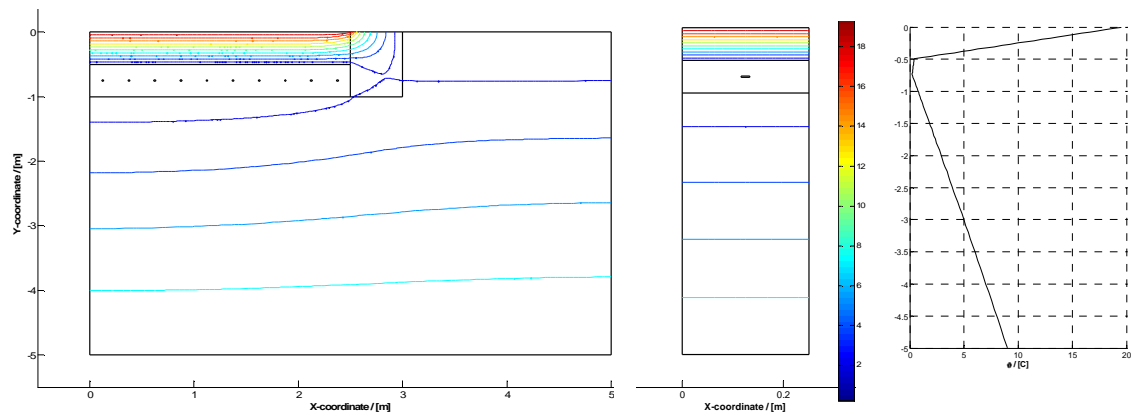

Fig. 6: Specific extraction heat (q) as a function of the pipe spacing (d) or the pipe length (L), respectively for a constant ground heat exchanger area of 100 m<sup>2</sup>; Boundary and initial condition top:  $\vartheta_0 = \vartheta_{BC} = 10$  °C and bottom:  $\vartheta_0 = \vartheta_{BC} = 8$  °C; PE pipe DN 20, charging with  $V = 580$  l/h, 40 % water glycol mixture

Both models implemented in MATLAB (s-fun, pdepe) provide almost identical results. For large pipe spacing ( $> 1$  m) good results are obtained with the radial symmetric model, but the 1D-model overestimates the extraction heat. For smaller pipe spacing, the 1D-model yields better results and the radial symmetric model overestimates the extraction heat. In the range of spacing between 0.5 m and 1 m with both models not very accurate results are obtained. For large or small spacing, respectively, the remaining relatively small deviations with regard to the 2D-model can be explained among others by slightly different calculation methods for the temperature-dependent material properties and transfer coefficients.

For relatively small ground heat exchangers edge effects may not be neglected. Then a 2D or even 3D simulation is required. By means of comparison between 1D and 2D simulation results for several geometries and extraction profiles it could be demonstrated that for most cases 1D-models predict the behavior with satisfying accuracy. In Fig. 7 the contour plot of the 2D simulation with edge effects is compared to a 2D model where only a section is depicted. Furthermore the temperature profile of the 1D model described above is plotted. In the 2D case different dimensions of the slab and of the surrounding soil were considered (have slab 2.5 m and 5 m).



	2D	2D section (s)	1D
free	(2.5 m) 59.1 kWh (5.0 m) 43.8 kWh	48.4 kWh	56.57 kWh/m <sup>2</sup>
covered	(2.5 m) 35.8 kWh (5.0 m) 26.8 kWh	26.6 kWh	37.05 kWh

**Fig. 7: Contour plot of 2D model with edge effects (left), 2D model (section) using symmetry (without edge effect) and temperature profile of 1D model after 8760 h with a constant heat extraction with  $\vartheta_{in} = 0^\circ\text{C}$  ( $\dot{m} = 0.2$  kg/s) in months 1,2,3,10,11,12; (rest of year  $\dot{m} = 0$  kg/s)**

There are differences in the calculated extraction heat in the range of 10 to 20 %, see Fig. 8. For obvious reasons, in the case of the “small” ground heat exchanger with 2.5 m (half size) edge effects have more influence on the extraction heat than in the case of the 5.0 m ground heat exchanger.

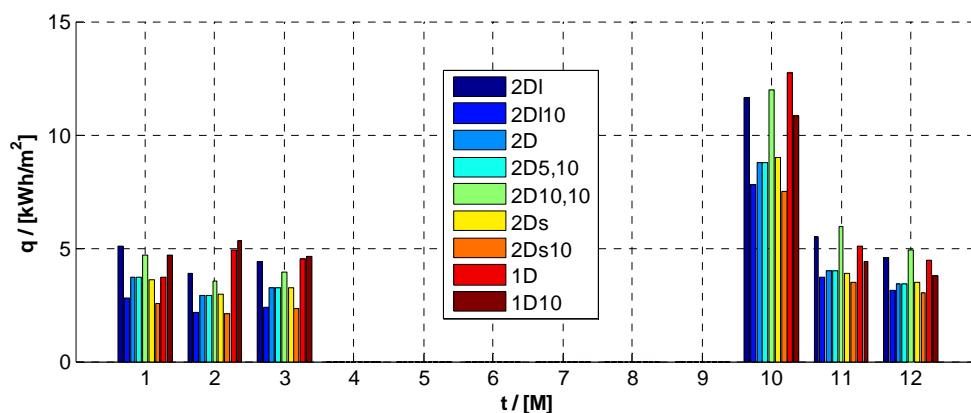
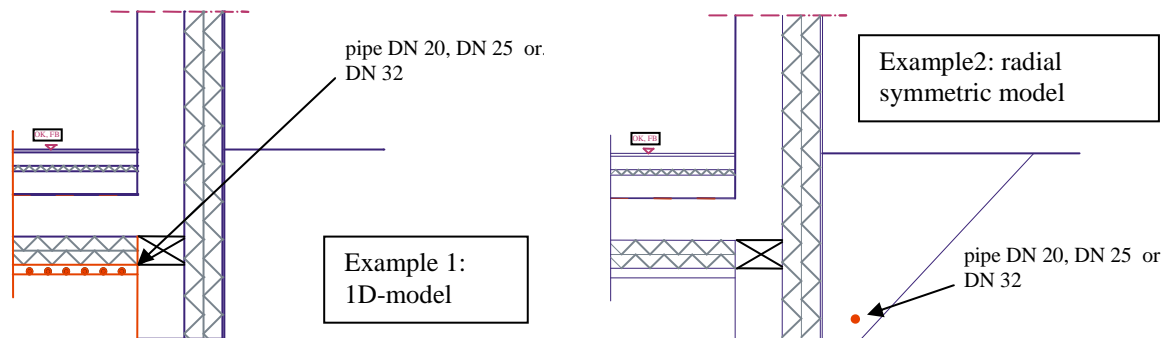

**Fig. 8: Monthly specific extraction heat ( $q$ ) for the model with 5.0 m slab with depth of 5 m (2DI) and 10 m (2DI10), model with 2.5 m slab with extension in x-direction of 5 m and 10 m and depth of 5 m and 10 m (2D, 2D5,10, 2D10,10); 2D model where a section is depicted with depth of 5 m and 10 m (2Ds, 2Ds10) and 1D model with 5 m (1D) and 10 m depth (1D10)**

The choice of the distance of boundary condition at bottom of the simulation domain (here 5 m or 10 m

below ground surface, indicated by “10”) is rather sensitive. The distance of right hand side boundary (5m or 10 m) does almost not influence the result if not chosen too narrow. The 2D model that depicts only a section of the ground heat exchanger does not yield significantly more accurate results than the 1D model. With both models climatic influences such as short and long-wave radiation rain, snow, cannot be predicted. Here, in the case of the 2D model a periodic ambient temperature based on monthly values (Innsbruck) has been assumed. In order to account for solar radiation the ambient temperature was increased by 1 K. The 1D-modell serves at least for prediction of general trends with sufficient accuracy. In particular for uncovered ground heat exchanger (next to the house) or in cases where there is ground water in shallow depths the agreement is rather good.

The radial symmetric model can be applied for brine heat exchangers, which are installed around the perimeter of the house in the excavated surrounding, see Fig. 9, right hand side. The choice of the boundary condition, a very sensitive value in this case, is complex, as it depends on several parameters such as the geometry (in particular depth  $z$ ), the distance of the building as well as on the temperature in the building (interior or cellar) and the respective U-values of the wall and slab as illustrated in Fig. 9.



**Fig. 9: Horizontal ground heat exchanger in blinding layer with 360 m piping in 4 parallel loops (1D model, left) and ground heat exchanger in surrounding excavation with a length of 52 m (right)**

The temperature of the boundary condition has to be determined by numerical simulation. Further investigations about the quality of such a simplified model in particular in the case of two parallel pipes are necessary and will be carried out in future. However, as a first approximation a damped and phase shifted temperature depending on the depth  $z$  and the soil dependent penetration depth  $\delta$  may be applied as boundary condition (Fig. 10).

$$\vartheta(t, z) = \vartheta_{e,m} + G_t \cdot z - \Delta \vartheta \cdot \exp\left(-\frac{z}{\delta}\right) \cdot \cos\left(2 \cdot \pi \frac{t}{t_0} - \frac{z}{\delta}\right) \quad (\text{eq. 9})$$

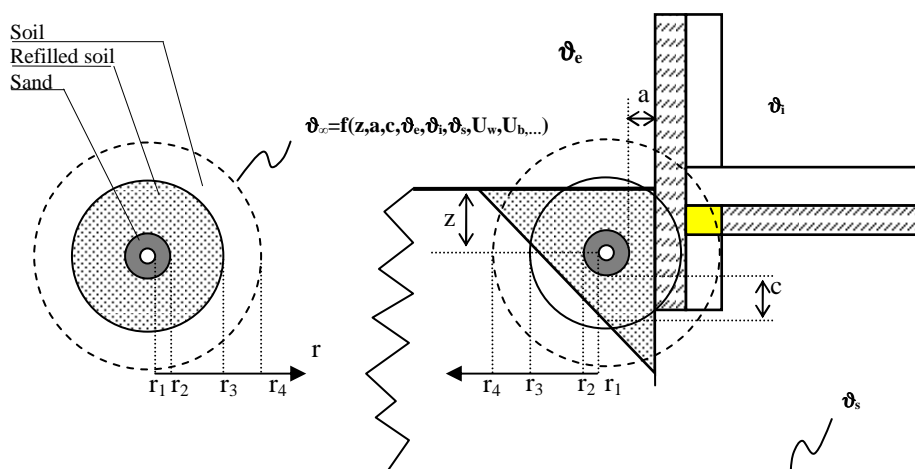

**Fig. 10: Complex 2D model of brine heat exchanger installed around the perimeter of the house in the excavated surrounding (right) and equivalent radial symmetric model with boundary condition depending on depth  $z$ , distance to the wall  $a$ , external ( $e$ ), internal ( $i$ ) and soil ( $s$ ) temperature and on the overall heat transfer coefficients  $U$  of wall ( $w$ ) and basement ( $b$ )**



## 6. Primary Energetic Evaluation of Solar Heat Injection

The injection of solar heat into the soil increases the temperature level of the soil below the building. Thus, the annual performance factor of the ground sourced heat pump can be increased. The resulting decrease in primary energy has to be compared with the expense of the solar heat injection i.e. energy consumption of the solar pump and control. An exact evaluation can only be performed by system simulation. Here, at first a more general estimation will be given, using the ground heat exchanger model described above: Four different variants of solar charging are compared with the reference case without solar heat injection. The extraction and injection of heat is modeled with a synthetic profile according to Table 2 as more general conclusions can be drawn and superimposition of effects can be excluded.

**Tab. 2: Synthetic profiles for heat extraction (heating) and solar heat injection (variants Solar V1 to V4) in hours per day**

	Jan	Feb	Mar	Apr	Mai	Jun	Jul	Aug	Sep	Okt	Nov	Dez
extraction	12	6	2	0	0	0	0	0	0	2	6	12
Solar V1	0	0	0	0	0	0	0	2	0	0	0	0
Solar V2	0	0	0	0	0	0	2	2	0	0	0	0
Solar V3	0	0	0	0	0	2	2	2	0	0	0	0
Solar V4	0	0	0	0	2	2	2	2	0	0	0	0

The resulting outlet temperature for an inlet temperature of 0°C (const.) is plotted in Fig. 11. Regarding the outlet temperature the influence of the different injection variants is small. After 1 year i.e. end of December the difference between the minimum outlet temperature with four months of solar heat injection (0.57 °C) and the minimum outlet temperature without solar heat injection (0.53 °C) is with 0.04 K almost negligible. Hence, at least for the consequent months (January, February and March) a positive effect of the solar heat injection is hardly observable. The resulting extracted heat for the five cases is summarized in Tab. 3.

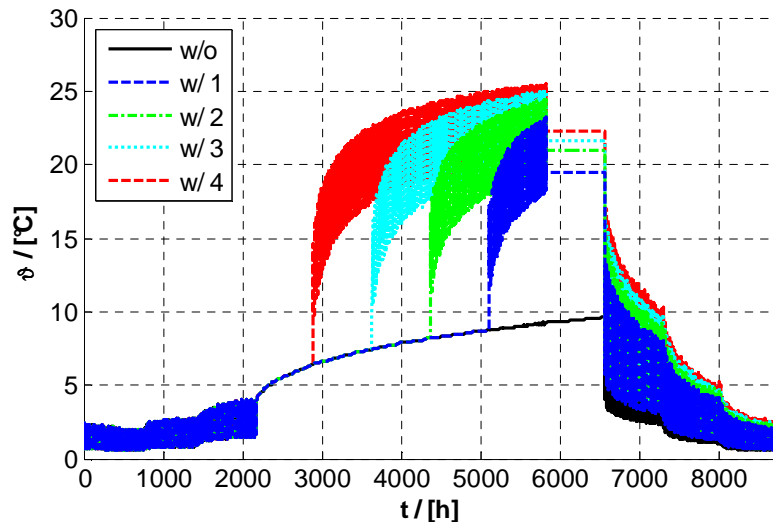

**Fig. 11: Course of temperature (after 1 month initial phase) without (w/o) solar heat injection and with (w/) solar heat injection (variants 1 to 4); constant mass flow of 0.17 kg/s 40 % water-glycol per pipe (PE, DN 20); inlet temperature 0 °C extraction and 40 °C injection;**

With solar heat injection the results of the first simulation year rather do not deviate from the following years. The system is nearly balanced after the one month initializing phase (deviation < 3 %). Without solar heat injection the temperature level further decreases after the first year. The extracted heat in the first year is about 12 % lower in year 2 compared to year 1.

For the primary energetic evaluation it is assumed that the expense for the solar heat injection  $Q_{\text{Solar}}$  with regard to the electricity consumption  $P_{\text{el,Solar}}$  of the circulation pump and the controller is 50 based on the

experience with the project mentioned above.

$$PF_{Solar} = \frac{Q_{Solar}}{P_{el,Solar}} \quad (\text{eq. 10})$$

The surplus heat  $Q_{extra}$  that can be extracted additionally (compared to the reference case without injection) becomes useful energy ( $Q^+$ ) by means of the heat pump. The performance factor of the heat pump is assumed to be 3 (the average brine temperature is in the range of 2 °C). The required extraction heat ( $Q^-$ ) is then

$$Q^- = Q^+ \left( \frac{JAZ - 1}{JAZ} \right) \quad (\text{eq. 11})$$

Without solar heat injection this surplus useful heat ( $Q^+$ ) has to be delivered by alternative means e.g. using an air sourced heat pump. Assuming a performance factor of 2.5 for the air sourced heat pump, the different cases can be evaluated based on primary energy units (PE factor for electricity 2.6)

Thus, the variants are not compared among each other, but it is determined for each respective variant whether the surplus heat gained due to solar heat injection is more favorable from the primary energy point of view than the alternative provision of the surplus heat by means of an air sourced heat pump. The relatively high performance factor of the air sourced heat pump of 2.5 seems appropriate as the additional useful energy of the variants with solar heat injection are mainly available in October where still moderate ambient temperatures can be expected. The primary energy of the surplus heat of the 5 cases (without solar w/o and variants V1 to V4 with solar w/) are summarized in Table 3.

**Tab. 3: Injected heat ( $Q_{Injection}$ ) and extracted heat ( $Q_{Extraction}$ ) as well as primary energy expenditure (PE) of the variant Solar injection and the reference variant with air-sourced heat pump**

/ [kWh]	w/o	w/ V1	w/ V2	w/ V3	w/ V4
$Q_{Solar}$	0	1573.61	2865.65	4044.52	5239.15
$Q_{Extraction}$	3024.35	3461.56	3742.88	3967.01	4183.63
$Q_{Extra}$	0	437.21	718.53	1413.99	1159.38
$PE_{Solar}$	0	650.20	1083.10	1435.77	1779.63
$PE_{Reference}$	0	682.05	1120.91	1470.55	1808.63

With the above mentioned assumptions, the variant solar heat injection ( $PE_{Solar}$ ) yields almost no benefits with regard to primary energy over an air sourced heat pump ( $PE_{Reference}$ ). Further, more detailed investigation is necessary. However, solar heat injection - if at all - seems to be beneficial only during the transition period, when injection is followed by a prompt extraction.

## 7. Cost-effective heating system for passive houses

The specific thermal heat demand of passive houses is limited to 15 kWh/(m<sup>2</sup> a) at a maximum heating load of 10 W/m<sup>2</sup>. It is determined according to the monthly balance method with the PHPP. With little error a synthetic monthly profile (see table 4) may serve for assessment of the potential of a horizontal ground heat exchanger as introduced above as source for a heat pump heating system. In reality, the monthly distribution is not symmetric; in particular, the heat demand is usually slightly higher in March than in October. However, this should not limit the general quality of the following conclusions. Taking a single family house with an treated floor area of 120 m<sup>2</sup> and a brine heat pump with an annual performance factor of 3 as an example, the required extraction energy for the ground heat exchanger (with an area of 120 m<sup>2</sup>) can be calculated as listed in Table 4.

The monthly calculated extraction heat ( $Q_{1D}$ ) lies even without solar injection with sufficient buffer above the required extraction heat ( $Q^-$ ) for the ground heat exchanger in the blinding layer (Fig. 9, left hand side). In the case of the second example, the pipe around the perimeter of the house installed in the excavated surrounding (with a length of 54 m, see Fig. 9, right hand side) the extracted heat ( $Q_{RS}$ ) is nearly enough if balanced over the entire year or the heating period, respectively. However, in January, February and March the extracted heat is not sufficient to cover the demand. It will be investigated more detailed in future whether and under which boundary conditions with a second pipe there may be potential for such a ground heat exchanger to serve as sole heat source for heating.

The performance of a ground heat exchanger installed in the blinding layer is less than that of the ground heat exchanger installed in the ground next to the building (depending on the depth some 10% to 20%). In addition, it must be considered that specific heat demand of a house with a ground heat exchanger in the blinding layer can increase by up to 1 kWh/(m<sup>2</sup> a) to 3 kWh/(m<sup>2</sup> a) in spite of a perimeter insulation of 30 cm, see Ochs et al. (2011). Whether these disadvantages are compensated by the more economic construction has to be determined individually.

**Tab. 4: Synthetic monthly distribution of heat demand ( $q$ /[kWh/m<sup>2</sup>]); required annual heat demand  $Q_+$  / [KWh] and required extraction heat  $Q_-$  / [KWh] for the ground heat exchanger, as well as potential extraction heat  $Q_{1D}$  / [KWh] for the 1D ground heat exchanger (piping in the blinding layer) and radial symmetric ground heat exchanger (RS) with piping in the surrounding excavation**

Month	days	$q$ / [kWh/m <sup>2</sup> ]	$Q_+$ /[kWh]	$Q_-$ /[kWh]	$Q_{1D}$ /[kWh]	$Q_{RS}$ /[kWh]
1	31	5	600	400	508	312
2	28	2	240	160	357	119
3	31	0.5	60	40	272	40
4	30	0	0	0	0	0
5	31	0	0	0	0	0
6	30	0	0	0	0	0
7	31	0	0	0	0	0
8	31	0	0	0	0	0
9	30	0	0	0	0	0
10	31	0.5	60	40	645	114
11	30	2	240	160	677	258
12	31	5	600	400	595	405
<b><math>\Sigma</math></b>	<b>365</b>	<b>15</b>	<b>1800</b>	<b>1200</b>	<b>3061</b>	<b>1249</b>

## 8. Conclusions

Ground-coupled heat pumps are increasingly demanded for heating. The power of most available heat pumps is too high for passive houses with the very low heating demand. The costs of vertical ground heat exchangers as well as of conventional horizontal collectors are generally not justified for a passive house. Here the development of low-cost solutions with customized power would make more sense. The feasibility of such cost-effective concepts could be demonstrated by few realized examples with ground heat exchanger in the blinding layer of the building. The solar heat pump system for a passive house presented in this paper represents an efficient heat supply system provided that the components are well dimensioned (in particular circulation pumps!) and the control strategy is well matched. However, compared to an air-to-air heat pump (optional with solar collectors for tap water heating) the investment costs are still relatively high and the system and control is complex and thus error-prone.

The experience with such systems is still limited and further optimization is required. Accordingly, the investigation of different variants by simulation is an effective and cost-efficient solution. Over-dimensioning causes unnecessarily high costs, whereas an under-sized system can lead to low efficiency of the ground heat exchanger and heat pump and even to the failure of the system.

In this paper types of ground heat exchangers that are available are discussed with focus on ground heat exchanger modeling. In particular for system simulations fast and therefore, simplified models are required. Two of such models are presented. Using these models, the thermal behavior of horizontal ground heat exchanger is examined in relation to the operation of the heat pump and the solar thermal system. The potential and the limits of horizontal ground heat exchanger are determined. The often overestimated potential of solar injection is demonstrated. Solar regeneration of the ground is, if at all, only beneficial during the transition period just before the heating season. Provided a well-matched dimensioning of the components combined with an intelligent control with this concept, an efficient and cost-effective heating system for passive houses can be realized even without solar injection. A detailed individual investigation is however highly recommended.

For a simple and cost-effective heat pump based heating system for passive houses (in conjunction with solar domestic hot water systems) a ground heat exchanger installed in the excavated surrounding of the building

in conjunction with a thermal activation of the intermediate ceiling as sole heat distribution system may be a good option. Further detailed investigations with enhanced models which include e.g. freezing and especially field measurements will be necessary.

## 9. References

Cauret O., Michel Bernier, Experimental validation of an underground compact collector model, Effstock, Stockholm, 2009

Chiasson A., Modeling Horizontal Ground Heat Exchangers in Geothermal Heat Pump Systems, COMSOL Conference Boston, 2010.

Glück B., Simulationsmodell für Erdkollektoren <http://berndglueck.de/>, 2009.

Hollmüller P., Lachal B, Buried pipe systems with sensible and latent heat exchanges: validation of numerical simulation against analytical solution and long-term monitoring, in : Building Simulation, 9th International Building Performance Simulation Association, Montréal, Québec, 2005

Meyer, M., KOMPAKT UND KOMFORTABEL, heizen und lüften, [www.airoptima.de/resources/6seitenKompaktanlagen.pdf](http://www.airoptima.de/resources/6seitenKompaktanlagen.pdf), 2010

Ochs, F., Simulationsstudie zum Projekt Passivhaus Houwen, Untersuchung und Optimierung des Wärmeversorgungssystems, unveröffentlichter Bericht, Innsbruck, 2010.

Ochs F., Peper S., Schnieders J., Pflüger R., Feist W., Neues Solar-Wärmepumpen-Konzept für die Wärmeversorgung von Passivhäusern - Beurteilung der Effizienz durch Monitoring und Simulation, 21. Symposium Thermische Solarenergie, Kloster Banz, Bad Staffelstein, 2011

Feist W., Arbeitskreis kostengünstige Passivhäuser, Protokollband Nr. 17 - Jahr 1999, Dimensionierung von Lüftungsanlagen in Passivhäusern, Darmstadt, 1999

Feist W., Arbeitskreis kostengünstige Passivhäuser, Protokollband Nr. 20 - Jahr 2000, Passivhaus-Versorgungstechnik, Darmstadt, 2000

Feist W., Arbeitskreis kostengünstige Passivhäuser, Protokollband Nr. 26 - Jahr 2004, Neue Passivhaus - Gebäudetechnik mit Wärmepumpen, Darmstadt, 2004

Peper, S.; Schnieders, J.; Ochs, F., Feist, W.; Messtechnische Untersuchung und wissenschaftliche Auswertung zur saisonalen Wärmespeicherung über Sole-Register unter der Bodenplatte eines Passivhauses mit Dämmschürze Abschlussbericht, Forschungsvorhaben Aktenzeichen: Z 6 – 10.08.18.7-06.19. / II2-F20-06-013, im Auftrag des BBR, Darmstadt, 2010.

[http://www.passivhaustagung.de/Passivhaus\\_D/PHPP.html](http://www.passivhaustagung.de/Passivhaus_D/PHPP.html), 2007.

<http://www.ah-passivhaus.at/home.php>, 2010

<http://www.comsol.com>, 2011.

<http://www.mathworks.com>, 2011.

CARNOT Blockset, Version R2009: Solar-Institut Jülich, 2009