

# Advanced and Sustainable Housing Renovation





## IEA Solar Heating and Cooling Programme

The *International Energy Agency* (IEA) is an autonomous body within the framework of the Organization for Economic Co-operation and Development (OECD) based in Paris. Established in 1974 after the first “oil shock,” the IEA is committed to carrying out a comprehensive program of energy cooperation among its members and the Commission of the European Communities.

The IEA provides a legal framework, through IEA Implementing Agreements such as the *Solar Heating and Cooling Agreement*, for international collaboration in energy technology research and development (R&D) and deployment. This IEA experience has proved that such collaboration contributes significantly to faster technological progress, while reducing costs; to eliminating technological risks and duplication of efforts; and to creating numerous other benefits, such as swifter expansion of the knowledge base and easier harmonization of standards.

The *Solar Heating and Cooling Programme* was one of the first IEA Implementing Agreements to be established. Since 1977, its members have been collaborating to advance active solar and passive solar and their application in buildings and other areas, such as agriculture and industry. Current members are:

Australia	Finland	Portugal
Austria	France	Spain
Belgium	Italy	Sweden
Canada	Mexico	Switzerland
Denmark	Netherlands	United States
European Commission	New Zealand	
Germany	Norway	

A total of 44 Tasks have been initiated, 33 of which have been completed. Each Task is managed by an Operating Agent from one of the participating countries. Overall control of the program rests with an Executive Committee comprised of one representative from each contracting party to the Implementing Agreement. In addition to the Task work, a number of special activities—Memorandum of Understanding with solar thermal trade organizations, statistics collection and analysis, conferences and workshops—have been undertaken.

To find Solar Heating and Cooling Programme publications and learn more about the Programme visit [www.iea-shc.org](http://www.iea-shc.org) or contact the SHC Secretariat, Pamela Murphy, e-mail: [pmurphy@kmgrp.net](mailto:pmurphy@kmgrp.net).

## Current Tasks & Working Group:

- Task 36 *Solar Resource Knowledge Management*
- Task 37 *Advanced Housing Renovation with Solar & Conservation*
- Task 38 *Solar Thermal Cooling and Air Conditioning*
- Task 39 *Polymeric Materials for Solar Thermal Applications*
- Task 40 *Towards Net Zero Energy Solar Buildings*
- Task 41 *Solar Energy and Architecture*
- Task 42 *Compact Thermal Energy Storage*
- Task 43 *Rating and Certification Procedures*
- Task 44 *Solar and Heat Pump Systems*

## Completed Tasks:

- Task 1 *Investigation of the Performance of Solar Heating and Cooling Systems*
- Task 2 *Coordination of Solar Heating and Cooling R&D*
- Task 3 *Performance Testing of Solar Collectors*
- Task 4 *Development of an Insolation Handbook and Instrument Package*
- Task 5 *Use of Existing Meteorological Information for Solar Energy Application*
- Task 6 *Performance of Solar Systems Using Evacuated Collectors*
- Task 7 *Central Solar Heating Plants with Seasonal Storage*
- Task 8 *Passive and Hybrid Solar Low Energy Buildings*
- Task 9 *Solar Radiation and Pyranometry Studies*
- Task 10 *Solar Materials R&D*
- Task 11 *Passive and Hybrid Solar Commercial Buildings*
- Task 12 *Building Energy Analysis and Design Tools for Solar Applications*
- Task 13 *Advanced Solar Low Energy Buildings*
- Task 14 *Advanced Active Solar Energy Systems*
- Task 16 *Photovoltaics in Buildings*
- Task 17 *Measuring and Modeling Spectral Radiation*
- Task 18 *Advanced Glazing and Associated Materials for Solar and Building Applications*
- Task 19 *Solar Air Systems*
- Task 20 *Solar Energy in Building Renovation*
- Task 21 *Daylight in Buildings*
- Task 22 *Building Energy Analysis Tools*
- Task 23 *Optimization of Solar Energy Use in Large Buildings*
- Task 24 *Solar Procurement*
- Task 25 *Solar Assisted Air Conditioning of Buildings*
- Task 26 *Solar Combisystems*
- Task 27 *Performance of Solar Facade Components*
- Task 28 *Solar Sustainable Housing*
- Task 29 *Solar Crop Drying*
- Task 31 *Daylighting Buildings in the 21<sup>st</sup> Century*
- Task 32 *Advanced Storage Concepts for Solar and Low Energy Buildings*
- Task 33 *Solar Heat for Industrial Processes*
- Task 34 *Testing and Validation of Building Energy Simulation Tools*
- Task 35 *PV/Thermal Solar Systems*

**C**ompleted Working Groups:

*CSHPSS, ISOLDE, Materials in Solar Thermal Collectors, Evaluation of Task 13 Houses, and Daylight Research*



# Contributors

This handbook is produced from material developed in the course of IEA SHC Task 37 Advanced Housing Renovation by Solar and Conservation. Operating agent was Fritjof Salvesen from Norway. This venture brought together some 50 experts from 12 countries. The objective of this task was to develop a solid knowledge base how to renovate housing to a very high energy standard while providing superior comfort and sustainability and to develop strategies which support market penetration of such renovations explicitly directed towards market segments with high renovation and multipliable potentials. The task was divided in four subtasks:

- **Subtask A: Marketing and Communication Strategies**

Subtask Lead Country: Norway. Lead: Are Rødsjø, The Norwegian State Housing Bank,

- **Subtask B: Advanced Projects Analysis**

Subtask Lead Country: Switzerland. Lead: Robert Hastings, AEU GmbH, CH.

- **Subtask C: Analysis and Concepts**

Subtask Lead Country: Germany. Lead: Sebastian Herkel, Fraunhofer Institute, Solar Energy Systems

- **Subtask D: Environmental Impact Assessment (EIA)**

Subtask Lead Country: Belgium. Lead: Sophie Trachte; Architecture et Climat, Belgium

For more information: <http://www.iea-shc.org/task37>

This booklet is produced in Subtask D; Environmental Impact Assessment (EIA).

Main authors are Sophie Trachte and André Deherde from Architecture et Climat, Belgium

Issuing date: June 2010



# Table of content

## Foreword

### Chapter 0 : Introduction

---

Sheet 001: Sustainable renovation: definition and priorities

Sheet 002: From bioclimatic to sustainable architecture

Sheet 003: Some questions about housing renovation

### Chapter A : Increase the comfort of life

---

#### ***A.1. Increase the quality of the outdoor spaces***

Sheet A10: Favour social interactions

Sheet A11: Favour soft mobility

Sheet A12: Favour and reintroduce biodiversity

#### ***A.2. Increase the quality of indoor air***

Sheet A20: Limiting sources of indoor pollution

Sheet A21: Optimizing the ventilation system

#### ***A.3. Acoustic comfort***

Sheet A30: Basic notions

Sheet A31: Principles of acoustic insulation and correction

Sheet A32: Optimizing the acoustic comfort

### Chapter B: Reduce energy consumption

---

#### ***B.1. Increase the thermal performances of housing***

Sheet B10: Optimizing the external walls performances

Sheet B11: Optimizing the shape

Sheet B12: Additional insulation in housing renovation

Sheet B13: Improving the air tightness

Sheet B14: Reducing the thermal bridges

Sheet B15: Thermal inertia in housing renovation

Sheet B16: Optimizing the solar protections

Sheet B17: Natural nightcooling

Sheet B18: Optimizing the window conception

Sheet B19: "Passivhaus" standard in housing renovation

***B.2. Reduce fossil energies consumption***

Sheet B20: Optimizing the heating system

Sheet B21: Optimizing domestic hot water

Sheet B22: Heat pump for heating production

Sheet B23: Hot water production by solar energy

Sheet B24: Optimizing the lighting system

Sheet B25: Renewable energies for generating electricity

Sheet B26: Heat recovery on ventilation system

Sheet B27: Air pre-heating by airground exchanger

**Chapter C: Reduce the tap water consumption**

---

Sheet C01: Rational use of tap water

Sheet C02: Recovery and use of rainwater

**Chapter D: Increase the water resources**

---

Sheet D01: Water management on the parcel

Sheet D02: Water recycling by plants

Sheet D03: Water recycling in urban area

**Chapter E: Reduce production of waste**

---

***E.1. Reduce construction and demolition waste***

Sheet E10: Preventive measures to reduce waste

Sheet E11: Waste management on building site

***E.2. Reduce domestic waste***

Sheet E20: Preventive measures to reduce domestic waste

**Chapter F: Reduce consumption of territory and resources**

---

Sheet F01: Embodied energy consumption

Sheet F02: Construction materials

**References**

**Table of illustrations**

**Appendixes**

# Foreword

This handbook was drafted in the context of an agreement between the Walloon Region and the Louvain-la-Neuve Catholic University on sustainable, energy efficient renovation of Walloon housing and is mainly intended for architects and architecture students.

At a time when major climate change and the aspiration for sustainable economic and social development while maintaining standards of living have become major issues, the objective of this guide is to consider renovation of housing from an overall standpoint by developing guidelines not just in terms of energy performances but also in terms of comfort, quality of life, environmental impact and resource consumption.

The entire guide is richly illustrated with both explanatory diagrams and photographs of examples of construction. Many graphs and tables also complete the written text. The guide provides designers with information and resources needed to renovate both individual and collective housing.

The main difficulty encountered in drafting this handbook lies in the authors' decision to make the guide applicable to all Europe, from the northern countries to southern Italy. Generally speaking, the authors have taken account of the characteristics of middle European countries: Germany, Austria, Belgium, France, the Netherlands, Switzerland, ... and give details for the northern countries when necessary.

It is up to the architect or the student to consider this work as an aid and to integrate the principles it proposes into his/her own approach to design, given the local climate and the standards and/or legislation in force.

The guide is divided into six chapters, each corresponding to a priority in energy efficient, sustainable renovation of housing.

The first chapter deals with the quality of life of inhabitants and three factors that influence it: quality of external and collective areas, interior air quality and acoustic comfort.

The second chapter, which is the largest one, concerns reduction of fossil energy consumption. It goes into two intrinsically related themes namely optimization of performances of the housing envelope to increase thermal and visual comfort of the occupant, and optimization of performances of systems and techniques installed in the housing unit. This chapter also goes into the use of renewable energy in systems such as photovoltaic solar energy, thermal solar energy, heat pumps etc.

The third and fourth chapters deal with the problem of water in a housing unit, considering the following themes: reduction of consumption of drinking water, use of rainwater, treatment of rainwater and runoff water on the lot and recycling wastewater.

The fifth chapter studies the question of waste, both as concerns the renovation itself and the use of the building. This chapter provides food for thought in terms of waste prevention and management.

The last chapter considers the use of the territory and resources in two data sheets: one on embodied energy consumption associated with the renovation project, the other on the impact of building materials.

Each theme considered in the guide is presented in the form of a data sheet several pages long.

So the architect can either use the entire guide or look up certain specific information, in view of the progress of his/her project.

It is important to realize that there is no standard way of achieving sustainable renovation. On the contrary, there are many ways that depend on many parameters: typology of the dwelling, quality of the existing building, type of renovation proposed, budget set aside for the renovation, quality of the context, ...

It must also be stressed that energy efficient, sustainable renovation is not unaffordable.

The idea is to reach a certain level of performance that is entirely accessible in renovation that will allow for better comfort – both indoors and outdoors – energy savings and reduced environmental impact.

If you think that renovation is indispensable, dare to aim for sustainable renovation!

We hope you enjoy this guide.



# 0. INTRODUCTION

- 001 - Sustainable renovation : definition and priorities
- 002 - From bioclimatic to sustainable architecture
- 003 - Some questions about housing renovation

*Sterrenvel renovation - Brussel*









## 0. INTRODUCTION

# Sustainable renovation : definition and priorities

N° of Sheet:  
**001**  
 Cross-references:  
**002, 003**  
 Appendix:  
 /

*“Sustainable development is development that meets the needs of the present without compromising the ability of future generations to meet their own needs. It contains within it two key concepts: the concept of ‘needs’, in particular the essential needs of the world’s poor, to which overriding priority should be given; and the idea of limitations imposed by the state of technology and social organization on the environment’s ability to meet present and future needs. »*

Brundtland Report «Our common future» 1987

«Advanced» renovation of housing – whether collective or individual – is above all else based on the reduction of energy consumption (heat, air-conditioning, ventilation, ...).

However, to be considered «sustainable», it must also correspond to the global concept defined by the Rio declaration (1992) and the 27 principles drafted in application of the definition of sustainable development proposed by Gro Harlem Brundtland.

### 1. THE 5 MAIN PRINCIPLES OF RIO CONVENTION (1992)

The Brundtland Report, «Our common future», was a response to a request made by the United Nations in 1987 to form a committee of international experts to analyze the deterioration of man’s environment and natural resources, as well as the consequences from the economic and social standpoint. It gave an alarming picture of the state of the environment and social, economic, cultural and political development on a worldwide scale. They were considered interdependent and non-sustainable along the current trend. A new orientation for the development question was proposed; it was referred to as «sustainable». 27 principles defining this concept have been established. These principles can be summarized into five major concepts:

***The principle of integrating environmental, social, economic and political dimensions.***

Environmental capital includes the environment, comprised of biological diversity and the reserves of natural resources, both exhaustible and renewable. Social capital includes health, capacities, knowledge, know-how, training, culture, experience of populations, and the relationships that a society proposes to its members. Economic capital includes financial capital as well as physical or material capital such as technical infrastructures, machines, buildings, ... political capital consists of customs, laws, and various categories of institutionalized organizations at different levels of power.

*Sustainably renovated housing has all the usual qualities of a dwelling (functionality, performance, techniques, ...) but the conditions of its environmental, economic, and social impact are minimized in the long run:*

- **on all scales:** from quality and comfort of indoor areas up to the planetary scale, including outdoor areas around the dwelling;
- **at all time:** from extraction of the necessary raw materials to renovation and demolition.



↑ Illustration 01: Gro Harlem Brundtland - Rio Convention (1992)

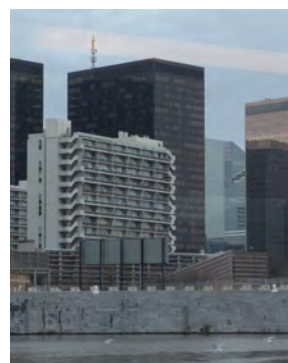
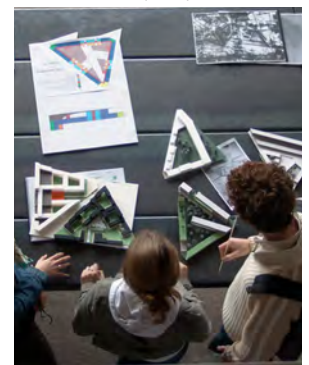

- ↖ Illustration 02 : Environmental capital
- ↑ Illustration 03: Social capital
- ← Illustration 04: Economical capital

**The principle of inter- and intra-generational equity**

This principle means that we must consider the entire environment and the balance between the 4 types of capital defined above as we would an inheritance: we have the right to inherit them and consequently to enjoy them equitably within our generation, but we also have the obligation to transmit them to future generations without dilapidating them, and better still, having enriched them.

*Sustainable renovation of housing is renovation that will take account of today's criteria for good housing, while maintaining the capacity to satisfy future needs without generating major environmental nuisance for current and future generations.*

**The principle of precaution**

This principle means that hypothetical or potential risks must be limited. It goes beyond the idea of prevention that is restricted to limiting proven risks. In other words, we must think about the consequences of our actions – our responsibility is no longer retrospective, it becomes prospective.

*Sustainable renovation of housing is renovation that limits risks both as concerns the health of workers, users and the overall environment, and it takes into account the various phases of the life of a dwelling: manufacture, construction site, use and elimination.*

**The principle of common responsibility**

This principle affirms our common responsibility with regard to the issues of sustainable development, while maintaining that, although this responsibility is common to all, there is differentiation nevertheless: Occidental countries have a greater responsibility for the deterioration of environmental and social capital, and they have the economic and political capital most apt to reverse the trends.

*Sustainable renovation of housing is renovation that takes account of the four dimensions listed above, of current and future needs, and of the various phases of the project (design, construction, utilization and end-of-life).*

*A responsible designer is a designer who also limits the impact of his/her project, both on the immediate environment (biodiversity, water resources, ...) and on the general environment (energy consumption, location, emission pollutants etc.).*

**The participation principle**

Citizen participation (re)locates decisions on the scale of the milieu for which they thus become players. It facilitates taking account of local particularities; it allows for appropriation of choices that have become collective; it ensures multiple solutions and points of view.

*Sustainable renovation of housing is renovation that cannot function without the active awareness and participation of the inhabitants.*



↑ Illustration 05 : Equity between peoples: color and ages



↑ Illustration 06 : Security on building site



↑ Illustration 07: Respect of human health



↑ Illustration 08: Tchernobyl disaster (1986)

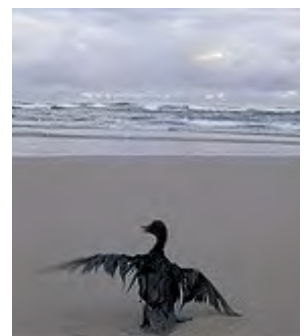

↑ Illustration 09: Oil disaster



↑ Illustration 10 : «White walk» in Brussel after «Dutroux» case

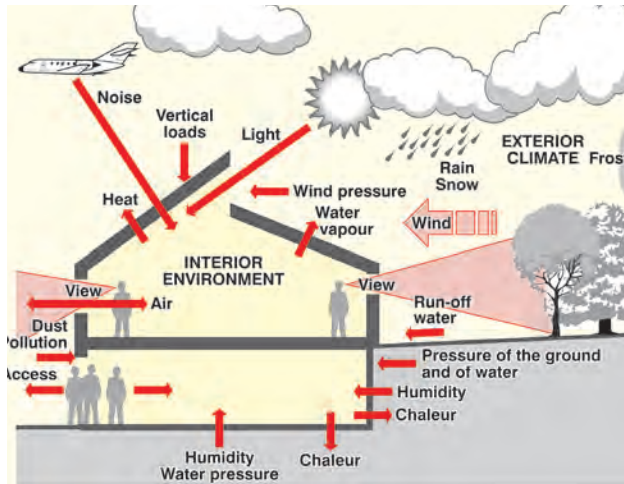

↑ Illustration 11: Illustration of the sustainable architecture definition

## 2. DEFINITION OF SUSTAINABLE ARCHITECTURE

On the basis of the 27 principles comprising the concept of sustainable development, sustainable architecture can be defined as an architecture that:

### ***Benefits from the advantages of its milieu, of all its milieus***

These consist of the climactic milieu (orientation, solar gains, ventilation, shade etc.), the geological milieu (earth, soil, altitude etc.), the hydric milieu (resource, treatment, distribution, conservation etc.), the vegetation milieu (trees, crops etc.), the institutional milieu (ways of living together), the infrastructure milieu (networks, ...), the technological milieu, the organizational milieu (social mixity, functional mixity etc.), and heritage (buildings, landscapes etc.).

### ***Protects against aggressions from the milieu***

This refers to protection against cold, heat, rain, noise, pollution, the risk of flooding as well as insecurity, lack of drinking water, limitation to a single generation or a single function, lack of public transport, harmful materials etc.

### ***Gives the environment to which the project belongs the benefit of sustainable improvements***

Constructing a building which, if it were to disappear, would not take anything away from the environment in which it stands, is not erecting a sustainable building. Architecture should be part of a triple context: the past that it inherits, the present that it constructs, and the future that it transmits.

### ***Protecting the milieu from the environmental nuisances of the construction itself***

These include atmospheric and hydric pollution associated with the manufacture of the component materials, the production of waste (household waste, demolition etc.), sound pollution, additional traffic, impermeabilization of the soil, ...

## 3. SIX PRIORITIES FOR THE RENOVATION OF HOUSING

The objective of the sustainable renovation process is to extend the life of an existing building, to give it a second life while limiting its impact on the environment. For this reason, the following priorities should be taken into account at each stage: design, construction and use of the building:

- **Increasing the comfort of life:**
  - to increase the quality of outdoor areas
  - to increase the quality of indoor air
  - to increase the acoustical comfort
- **Limiting energy consumption:**
  - to increase the thermal comfort
  - to reduce fossil energy consumption
- **Limiting drinking water consumption;**
- **Increasing the water resources;**
- **Limiting the production of waste;**
- **Limiting consumption territory and resources**

This set of six priorities is defined and explained in the six chapters of this handbook.

**3.1. Increasing the comfort of life**

Renovation of buildings, and particularly residential buildings, is often made necessary by a lack of comfort in general. Renovation is also an opportunity to increase both the energy efficiency of the building and the comfort of the indoor areas. Increasing the comfort of indoor areas means that an effort will be made in terms of the occupant’s thermal comfort (summer and winter), acoustic comfort, respiratory comfort and visual comfort.

Further still, health is a major concern in terms of quality of living. Taking account of risks to health, both to workers in the building sector (toxic materials and emissions during manufacture and implementation) and to the occupants (quality of air, quality of water, choice of building materials etc.).

The renovation of an existing building will not only modify the life of the occupants, it will also change the environment and the daily living context of all immediate neighbours. The building and its renovation can be the origin of nuisance (source of noise or pollution, increase in traffic and parking problems, blocking out sunshine, ...) as well as enrichment (new shops near by, noise screen, new green area and so on).

To be sustainable, the renovation process must also be an occasion for improving the quality of life associated with the immediate surroundings (social, environment, both man-made and natural, economic aspects). And each contracting authority or designer, aware of its responsibility for sustainable modifications that the renovation will impose on an existing environment, may wish to go further than recommended by the urban planning rules.

Increasing the comfort of the outdoor areas in the vicinity means making an effort in favour of cultural areas and green areas, promoting both social and functional mingling, favouring non-motorized mobility and biodiversity.

**3.2. Limiting energy consumption**

Global energy demand is expected to rise by nearly 60% over the next 20 years and the building sector represents 40% of this world’s total energy demand.

Given current energy consumption, our traditional primary energy reserves will be consumed in less than a century. No doubt there will still be reserves as yet unknown, but the practical and financial resources needed to find them and exploit them are colossal.

In addition, given the current cost of non-renewable energies and their increase by 2020, many households with low and medium incomes will have to choose between their food and their heating budgets.

Moreover, this overconsumption of fossil energy also has dramatic consequences on the environment (global warming, acidification of air, water and soil, formation of tropospheric ozone, ...) and on the health of living things (effects ranging from simply getting tired or headaches to respiratory disorders, allergies, bronchitis, chronic sinusitis or even cancer, disorders in reproductive health and foetal development and increased mortality).

*Consequently, it has become urgent to consume **LESS, BETTER AND DIFFERENTLY** by applying the following principles:*

- radically reduce our energy consumption
- use renewable energies insofar as possible;
- promote public transport and non-motorized transport



↑ Illustration 12 : Quality of outdoor spaces: colors, lighting, spaces diversity



↑ Illustration 13 : Necessity of playgrounds for the urban comfort

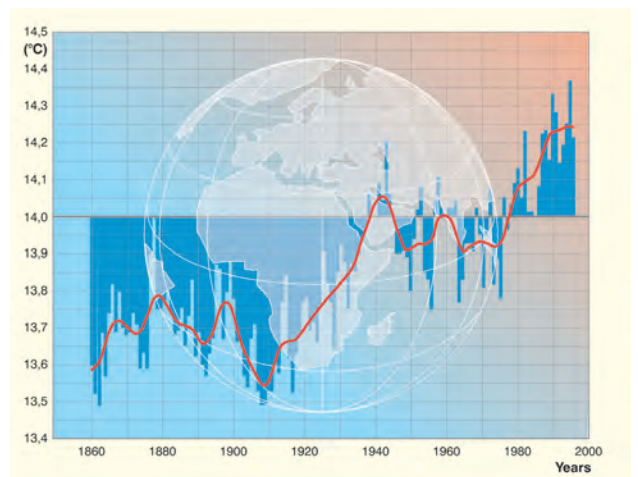

↑ Illustration 14: Global Warming since 1860



↑ Illustration 15 : Soft mobility today

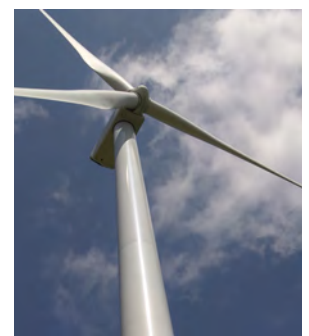

↑ Illustration 16: Renewable and clean energy



↑ Illustration 17 : Water is essential good for life on Earth



↑ Illustration 18:  
 Average water consumption in Europe



↑ Illustration 19:  
 Bad water consumption habit



↑ Illustration 20 : Water resources

### 3.3. Limiting consumption of drinking water

Fresh water is an indispensable good for the survival of all ecosystems present on Earth. This precious good is not in inexhaustible supply: while 70% of the Earth's surface is under water, fresh water represents only 3% of this quantity of which 0.26% is directly available for human consumption.

In addition, during the last 50 years, the quantity of fresh water available on Earth has decreased by half and many countries or regions have fallen below the limit of hydric vulnerability (2000 m<sup>3</sup>/per capita/per year). In fact, we consume this precious resource immoderately, since the average daily consumption of drinking water per capita varies between 25 litres (developing countries) to 150 litres (Europe) and 360 litres (USA).

It should also be recognized that the quality of water present in the subsoil is increasingly poor and that treatments to make it potable involve increasingly complicated and costly processes. Paradoxically for these three observations, we consider that only 45% of our daily needs really require drinking water.

*Consequently, preserving our drinking water resources by consuming **LESS, BETTER AND DIFFERENTLY** is becoming urgent. This entails:*

- decreasing our consumption;
- having recourse to another source of water for needs that do not require drinking water

### 3.4. Increasing water resources

Throughout the world, increasing urbanization and growing size of towns, the growing density of built up areas and the increasing size of impermeable areas have resulted in a change if not the destruction of the BALANCE between built up areas and green areas with major effects on the management of rain water.

In fact, enlarging impermeable areas (essentially in highly urban zones) causes a large increase in the flow of water to the collective sewer systems which has the following consequences:

- rapidly saturating the existing networks and causing a risk of flooding
- increasing the volume of water to be processed
- increasing the costs associated with sewers and drainage

In addition, shrinking green areas and permeable areas means less supply goes to water tables. Growing urbanization, industry and large-scale agriculture induced by our organization of consumption cause rising pollution of our fresh water «reserves».

Natural disasters – flooding, rivers overflowing their banks, droughts, lack of water – prove that it is becoming urgent to RESTORE this indispensable balance and proper functioning of the water cycle in towns and urban areas.

*To restore this balance, each designer and contracting authority should take simple, effective measures to manage water on the parcel around the building to be renovated as effectively as possible. The main factors are:*

- increasing the coefficient of permeability of the lot;
- equipping the lot with retaining and infiltration facilities;
- choosing outdoor soil coverings that are permeable to water;
- treating waste water, reusing it or re-infiltrating it into the ground.

### 3.5. Reducing production of waste (construction and domestic waste)

#### 3.5.1. Construction waste

While most of us agree that raw material and energy resources are dwindling, today the construction sector is a large consumer of both energy and raw materials, as well as a major producer of waste (40% of the total production of waste). For example, the BRE in the UK estimates that the annual production of construction waste amounts to 6 tonnes per inhabitant, more than ten times the domestic waste.

Moreover, because of population growth, the growth of cities and particularly the growing number of restoration and demolition sites in large European cities after unrestrained constructions in the '60s and '70s, we expect that the amount of demolition and construction waste will increase radically in upcoming years.

Moreover, most of those waste, despite a real potential of recycling, are, from lack of infrastructures or lack of quality in the sorting process, treated by traditional waste processing systems, namely dumping and incineration. Those traditional waste processing systems have significant disadvantages both for the environment and for the health of living beings, and that are increasingly subject to regulation and control. Consequently, they are increasingly costly and sites of these activities will be more and more limited in Europe.

*Given these two observations, in terms of sustainable development there are only two alternatives:*

- *producing minimum waste or if possible not producing waste at all;*
- *sorting more at the place where the waste is produced in order to make the most of recycling.*

*Producing minimum waste entails major work on prevention in developing the renovation project – both in the design of the project itself and in the construction process used in the choice of materials.*

*Sorting more at source entails significant work on the way to take down a building and on waste management;*

#### 3.5.2. Domestic waste

In Europe, each person produces an average of 400 to 500 kg of waste per year – more than 1 kg per day. Despite the introduction of the domestic waste sorting, the amount of waste produced is constantly rising with an increasingly high percentage of packing waste (plastic, paperboard, paper etc.).

Moreover, most of those waste are treated by traditional waste processing systems, namely dumping and incineration. Those traditional waste processing systems have significant disadvantages both for the environment and for the health of living beings, and that are increasingly subject to regulation and control. Consequently, they are increasingly costly and sites of these activities will be more and more limited in Europe.

*Given these two observations, in terms of sustainable development there are only two alternatives:*

- *producing minimum of domestic waste*
- *sorting better and more at home*

*Producing minimum waste entails every citizen must become aware of his lifestyle and consumption -- a project designer has no influence on this aspect*



↑ Illustration 21: Sorting out the domestic waste - plastic



↑ Illustration 22: Sorting out the construction waste: container with wood



↑ Illustration 23: Specific waste bins



↑ Illustration 24: Urban exodus towards countryside



↑ Illustration 25 : Car movings linked to this urban exodus



↑ Illustration 26 : Stone-pit of Clypot - Neufvilles



↑ Illustration 27 : Stone-pit in Belgium

*Sorting more at source entails at the time of renovation, the designer should set up schemes and means to encourage each occupant to sort waste.*

### 3.6. Reducing consumption of territory and resources

In terms of territory and consumption of space, we must cope with two phenomena:

- **Growing urbanization of towns** with the consequence of increasingly dense constructed zones, greater congestion of road traffic, the decline of social relations, the lack of green areas and biodiversity, impermeability of soils etc.;
- **Urban exodus of residents from the centre of towns** towards the suburbs and the country, to improve their quality of life and relation to nature, resulting in a waste of territory and «virgin» areas, spreading of networks, overconsumption of energy and generalization of pollution.

These two opposite phenomena both have dramatic consequences on the environment, society and culture as well as on the local and world economy.

The concept of the territory is also related to exploitation of resources and the landscape. In terms of resources, the building sector in Europe uses 50% of all resources exploited. The resources used are for the most part either renewable (mainly natural plant materials that are renewed more or less rapidly) and non-renewable (gravel, stone materials, petrochemical materials and so on that have taken tens of thousands of years to form under ground).

In addition, exploitation of certain resources can have damaging consequences on the landscape, biodiversity and existing ecosystems. This is the case for deforestation of wooded areas in Canada and Siberia, certain granite and stone quarries, and mining of minerals or metals.

*It is becoming urgent to preserve our virgin areas, our ecosystems, our resources and our landscapes by working simultaneously on:*

- **The concept of a compact town:**
  - by making towns and man-made zones denser;
  - by making public transport networks denser;
  - by favouring social and functional mixity, so as to limit travel and social segregation;
  - by working on public space and green space.
- **A responsible choice of building materials:**
  - choosing materials made from natural raw materials, materials made from recycled or renewable substances with a high rate of renewal, raw materials present in sufficient and/or unlimited quantity;
  - choosing materials made from substances whose extraction or exploitation entails little or no harm for the landscape, the ecosystems and the environment in general.







## 00 INTRODUCTION

# From bioclimatic to sustainable architecture

N° of Sheet:  
**002**  
Cross-references:  
**001, 003**  
Appendix:  
/

*“Compared to the crisis that affects the environment, any other problem, be it social, political, economic or scientific, seems insignificant. It is obvious the questions that seem crucial today – human rights, peace in the Middle East, a vaccine for AIDS, public debt – would fade into the background if global warming, overpopulation, pollution or famine and lack of water were to cause our death.”*

*James Wines «The Green Architecture»*

### 1. THE INCEPTION OF BIOCLIMATIC ARCHITECTURE

#### 1.1. First half of the 20th century, when constraints were forgotten

From the end of prehistory to the 18th century, Man used almost exclusively renewable resources that came from the nature around him, to clothe, feed, heat and protect himself. The industrial revolution initiated by the discovery of coal, standardization of production and construction processes and the possibility offered by the railways to carry products easily everywhere in Europe, led to a profound change in the relations that man maintained with natural resources (or materials), particularly in their use, their transformation and their transport. This page of History marks the decline of local modes of production and construction adapted to local and regional climates. At the end of the 19th century, the beginning of the oil industry in Europe and the United States paved the way for the internal combustion engine leading to road-going vehicles, thermal power stations, aviation, ...

After the first world war, massive reconversion of chemical and mechanical industries, used to capacity for the war effort, for the production of new materials filled the gap created by the loss of craft skills, and then definitively took over, opening a new era in the world of construction.

In the period following the second world war, economic growth of industrial countries (essentially in the West) generalized the use of techniques in housing to ensure comfort of users in summer and winter. This is the period that definitively saw the separation of architectural design of housing, building techniques and the temperature problematic.

At the same time, evolution in lifestyles led us to continually growing expenditure of energy, not just in housing with an increase in the number of heated rooms, the period during which homes were heated, and the level of indoor temperature considered comfortable, but also in the way we function and travel.



↑ Illustration 28: Colliery memory



↑ Illustration 29: Colliery of Trieu Kaisin

The second half of the 20th century is also characterized by a waste of fossil fuels and almost exponential growth of:

- consumption of petroleum products;
- travel by road and by air notably (which consume the most energy);
- consumption of electricity.

### 1.2. The consequences of the 1973 and 1979 oil crises

The energy situation of housing, before the 1973 and 1979 oil crises, resulted from the simultaneous evolution of several technical-economic factors:

- the low price of energy (coal, oil and gas)
- the growth and development of thermal machines
- the development of industrial construction processes (rapid reconstruction due to the lack of housing up to the war) where only a quantitative or aesthetic performance was considered a priority.

In the 60s, a few people spoke out and tried to reverse the trend of overconsumption and this radical detachment from nature and tradition. They include:

- a few great architects such as Frank Lloyd Wright and Christian Norberg-Schulz who sought a symbiosis between architecture, the site, nature and tradition
- Club of Rome (1968) and the Meadows Report (1972) «The Limits to Growth» whose conclusions state that continued economic growth would result in a sharp drop in population due to pollution, impoverishment of cultivable soil and rarefaction of fossil energy in the 21st century.

But it took the 1973 and 1979 oil crises and their dramatic consequences (rocketing rises in the price of natural gas and petrol, as well as the resulting economic crises) to put a stop to this blissful ignorance by forcing awareness of the non-renewable nature of certain natural resources and the dangers of pollution.

### 1.3. Bioclimatic principles

The refusal to waste fossil energy and raw materials led certain architects to analyze the responses provided by local housing adapted to the specificity of the site and the climate.

Many innovations appeared during this period, particularly based on the concept of «solar architecture», and «solar passive».

All of these analyses and innovations gave rise to the definition of bioclimatic principles to reduce energy needs in housing and to provide comfort in a passive way, by a judicious choice of the location, orientation, shape and volume of the building, the materials and the vegetation planted nearby.

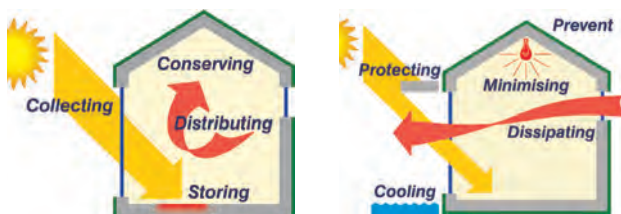

↑ Illustration 31: Bioclimatic principles

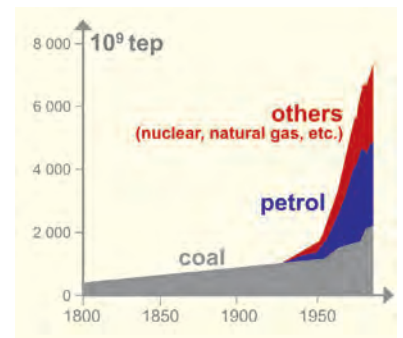

↑ Illustration 30: Fossil energies consumption since 1800

#### 1973 oil crisis:

The first oil crisis took place in 1973 and its effects were felt up to 1978.

On 16 and 17 October 1973, during the Yom Kippur war between Israel and an Arab coalition led by Egypt and Syria, the Arab and OPEC countries decided to put an embargo on oil to protest against the support that the United States provided to Israel: reduction of 5% of oil production until troops were evacuated from the occupied territories and Palestinian rights were recognized.

On 20 October, Saudi Arabia decided to enact a total embargo on deliveries to the United States, and then the Netherlands. The price of a barrel of oil on the free market rose from \$3 to \$18 in a few weeks. At the end of December, the OPEC countries coordinated the price per barrel at \$11.65.

The shortage created a panic; prices skyrocketed: they rose fourfold after the increases in October and December. Consumer countries reacted in a disorderly way and the United States was prepared to take military action on the Saudi peninsula to gain control of the main oil fields. After the sixth Arab summit in Algiers (26-28 November 1973), the United States had to readjust its policy which was considered too favourable to Israel; so did Western Europe and Japan. On 18 March 1974, Egypt obtained an end to the embargo.

#### 1979 oil crisis:

The second oil crisis took place in 1979. Under the combined effects of the Iranian revolution and the Iran-Iraq war, the price of oil rose 2.7 times between mid-1978 and 1981. On 8 September 1978 riots in Teheran were dealt with very violently – this day is now referred to as Black Friday. This was the beginning of the active period of the Iranian revolution that would end with the flight of the Shah on 16 January 1979. The Iran-Iraq war began on 22 September 1980. The price of a barrel of oil rose to \$39, the equivalent of \$92.50 in 2005.

Consumer countries all over the world panicked as they all tried to stockpile oil. Between October 1978 and June 1979 the price of crude and refined products moved into an upward spiral.

In this context, consumer countries first tried to save energy and then to find other sources of energy. This was the case for France that developed its nuclear industry. The reduction in consumption reversed the trend in oil prices as from the spring of 1981.

reversal of the oil economy marks from the 1981 spring.



↑ Illustration 32: Bhopal disaster - 1984



↑ Illustration 33:  
Tchernoby disaster - 1986

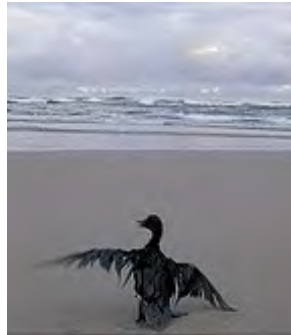

↑ Illustration 34:  
Oil disaster

## 2. THE BIRTH OF SUSTAINABLE ARCHITECTURE

### 2.1. From oil crises to the coming into effect of the Kyoto protocol (2005)

After growing awareness of the «finitude» of the world and its resources, as well as the increase in pollution associated with the consumption of fossil energy, several stages towards sustainable development can be pinpointed:

- **In June 1972**, a United Nations conference on the human environment in Stockholm particularly described eco-development, the interactions between the ecology and the economy, development and countries in the South and the North. Retrospectively this would be called the Earth Summit. It was a relative failure that reached no clear compromise, but the problematic had been described: the environment appears as a crucial world heritage that must be transmitted to future generations.
- **In 1983**, the United Nations appointed Norwegian Prime Minister Gro Harlem Brundtland to set up and preside a committee of international experts to analyze the deterioration of the human environment and natural resources, and the consequences from the economic and social standpoint.
- **In 1987**, the Brundtland report «Our Common Future» gave an alarming picture of the state of the environment and social, economic, cultural and political development on a worldwide scale. They were considered interdependent and non-sustainable along the current trend. A new orientation for the development question was proposed; it was referred to as «sustainable».

Alongside this report, catastrophes like famines in Africa, the pesticides leak in a plant in Bhopal, India (1984), discovery of the hole in the ozone layer (1985) or the nuclear accident at Chernobyl (1986) dramatically improved public awareness of the need for radical change in our relations to the social, political, economic and environmental dimensions.

- **In June 1992**, at the second Earth Summit in Rio de Janeiro, the international community proposed 27 principles comprising the concept of sustainable development defined in 1987 by Gro Harlem Brundtland. The international community also set an action plan for the 21st century – Agenda 21. The aim of these two major texts was to establish a framework at national and international level for future negotiations on the application of the concept of sustainable development.
- **In December 1997**, at the third United Nations Conference on climate change in Kyoto, a protocol was established with the objective of stabilizing the concentration of greenhouse gases in the atmosphere at a level that prevents any dangerous man-made disturbance of the climate system, and it was opened for ratification.

This protocol proposes a timetable for reducing the six greenhouse gases that are considered as the main cause of global warming for the past 50 years. It includes absolute commitments for the reduction of greenhouse gases for 38 industrialized countries, with a total reduction of 5.2% of carbon dioxide emissions by 2012, as compared to emissions in 1990.

- In **2002**, at the Johannesburg Earth Summit, more than 100 Heads of State and tens of thousands of government and NGO representatives ratified a treaty taking a position on the conservation of natural resources and biodiversity.
- In **2005**, the Kyoto Protocol on the reduction of greenhouse gases came into effect in the European Union.

Despite limited concrete actions, all of these stages have:

- informed everyone of the «non-sustainable» nature of our lifestyles and consumption,
- offered a worldwide approach to environmental, social, political and economic issues by reconciling various scales of action.

## 2.2. «Passivhaus» dwelling – how bioclimatic and technological principles can be combined

The Earth Summit in Rio de Janeiro in 1992 and the commitments made by many countries in favour of sustainable development have accelerated the process for generalizing an environmental approach in all economic sectors, and in particular in the construction sector.

Certain industrialized countries like Germany, Austria, Switzerland and the Scandinavian countries took measures to reinforce insulation and air tightness of the outside envelope of the buildings, combining these with effective techniques and integrating techniques associated with renewable energy. In terms of design of housing, stress is on significant reduction of energy consumption and the development of the so-called «renewable» techniques.

This determination, resulting from both industrial and political choices, gave rise to «passive» housing, which is defined by the Passivhaus Institut (Darmstadt) as housing that reaches a pleasant ambient temperature without conventional heat in the winter and without air conditioning in the summer.

Passive housing is not a type of construction, but a standard for construction that complies with certain performance criteria (see information sheet B19) and that reconciles increased indoor comfort for the occupant and significant reduction of energy consumption.

### 2.2. From «Passivhaus» dwelling to «sustainable» dwelling

At this time, all those involved in construction (from individuals to building companies, real estate developers, the authorities and architects) have understood the issues associated with consuming fossil energy and are beginning to modify their way of thinking and acting.

However, even if this first step is extremely important for the viability of our planet, it is not sufficient. Other thinktanks should be organized on a global scale on a number of issues including:

- consumption and distribution of drinking water;
- resource consumption;
- consumption of space;
- conservation of biodiversity;
- respect of health.

This means that a global approach defined by the concept of sustainable development (see information sheet 001) must also be integrated into housing and architecture in general.

↓ *Illustration 35:*  
*Consumption of tapwater*

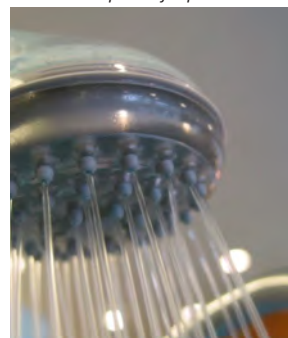

↓ *Illustration 36:*  
*Consumption of resources*

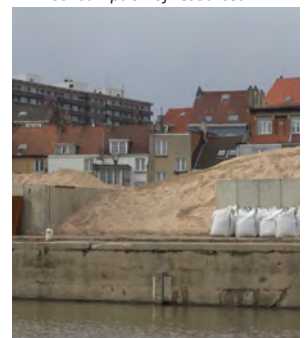

↓ *Illustration 37:*  
*Spaces consumption*



↓ *Illustration 38:*  
*Respect of human health*

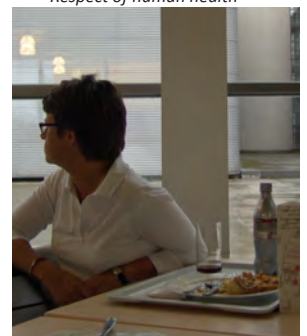



## 0. INTRODUCTION

# Some questions about housing renovation

N° of Sheet:  
**003**  
Cross-references:  
**001, 002**  
Appendix:  
/

Even before undertaking the design of a housing renovation project, it is essential to set certain energy and sustainable objectives.

The energy objectives will depend both on :

- the typology of the housing to be renovated (collective or individual, 2 or 4 façades),
- the type of renovation (light or heavy depending on the extent of the work) that one wishes to carry out.

The sustainable objectives will depend essentially on the designer's preference for:

- working in a global way by integrating priorities other than energy (water, waste, materials, ...),
- working with existing contexts (environment, social, economic),
- having the occupants of the housing unit or units participate in the renovation process to make them more aware and more responsible.

## 1. TYPOLOGY OF THE EXISTING HOUSING

In terms of sustainable renovation, priorities and issues are not the same when renovating a building with collective housing units or an individual home.

### 1.1. Collective housing

In the sustainable, global approach, renovation of collective housing should be done on two complementary levels:

- sustainably improving the performances of the building and the comfort of occupants while minimizing needs (energy, water, ...) and pollution;
- improving the urban context in which the building is located by promoting social exchanges, multipurpose functions, social mixity and by preserving biodiversity.

### 1.2. Individual housing

On an urban scale, renovation of an individual home has a smaller impact on the surrounding context than renovation of a collective building, even if the improvements in its energy and environmental performances play a role as concerns improvement of the global environment (on a worldwide scale).

Two different typologies can be identified:

#### - *Typology of raw house (2 façades)*

The typology of a house with two façades offers land use which, without being as effective as a collective housing building, can easily be included in environmental and energy concepts because of:

- its compact lay-out
- its density (use of less area)
- its proximity with existing networks

#### - *Typology of detached house (3 or 4 façades)*

Despite a general preference for this housing typology, a house with three or four façades corresponds to land use that consumes a large amount of space and energy (energy for operating it, and for transport and networks) due to the fact that the lay-out



↑ Illustration 39 : Sterrenveld social housing renovation in Brussel area



↑ Illustration 40: Deru housing renovation - Belgium

## 0. INTRODUCTION

# Some questions about housing renovation

N° of Sheet:  
**003**  
Cross-references:  
**001, 002**  
Appendix:  
/

is not compact, and that it entails dispersion in the territory. On renovating this type of housing, the designer should improve not only the energy and environmental performances but also the compactness and density of this typology of housing.

## 2. CONSTRUCTIVE MODE AND MATERIALS

On designing renovation, the designer must adapt to an existing building, which means using a specific mode of construction and certain materials.

Before taking thinking any further, it is important to identify these in order to maintain, accentuate or minimize certain physical properties such as inertia, installation, air tightness, the presence of thermal bridges, etc.

Depending on the period of construction, the place of construction and local tradition, one may find different materials in the walls, including a few examples of «massive» construction as described below:

### - *Very thick massive wal (mid-Europe)*

This type of wall corresponds to any traditional type of local construction (18th century to the beginning of the 20th century). The materials making up the walls are associated with local resources: Wood, earth, stone, cob, ...

### - *Solid bricks wall*

This type of wall was frequently used up to the 50s. The materials that make it up are often «traditional» materials such as stone or terra-cotta, or «industrial» materials like steel, cast iron, concrete ...

### - *Hollow wall "first generation"*

This type of wall appeared between the two world wars and presents the following characteristics:

- no insulation in the gap
- frequent connections between the facing and the bearing wall.

### - *Insulated hollow wall*

As a consequence of the oil crisis in 1973, this type of wall became very frequent as from the 80s, and includes insulation (initially partial and then total) in the gap.

One can also mention the various components of constructions made from wood, such as «solid» wood walls (timber) or wood framed walls, insulated or no.

It is important to specify that during the last century, radical changes took place in terms of the use of materials and the composition of walls:

- Industrialization of manufacturing processes and expansion of motor transport (or waterways and railways) initiated the decline in local modes of production and know-how adapted to local climactic conditions;
- After the first world war, reconversion of the chemical industries promoted the emergence of new materials, particularly synthetic materials such as nylon, teflon and polystyrene;
- After the second world war, the urgent need for housing gave rise to the development of prefabricated housing (particularly in concrete) and the glorious years (60s) marked the triumph of the separation of architectural design from materials and techniques in buildings.



↑ Illustration 41: Vernacular massive wall

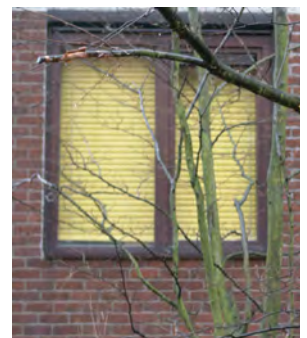
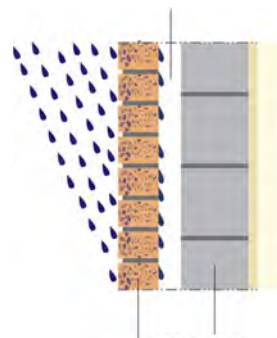

↑ Illustration 42: Hollow wall «first generation»

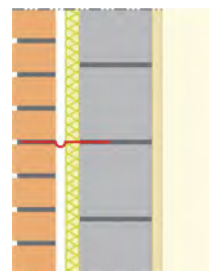

↑ Illustration 43: Insulated hollow wall



↑ Illustration 44: Wood frame work



↑ Illustration 45: Steel frame work



↑ Illustration 46: Old farm in countryside



↑ Illustration 47: Raw houses in countryside



↑ Illustration 48: Two housing typology in suburb area



↑ Illustration 49: Housing in downtown area

### 3. THE CONTEXT

The word “context” comes from the Latin verb “con textere”: “to weave with”. It refers to the concepts of networks (urban network, ecological grid), rhythm, interdependence (relation and interdependence of the renovated dwelling with its neighbourhood)...

In fact, the sustainable housing renovation process (individual or collective) consists of working on two scales of intervention:

- **Micro scale:** improving the habitability of the dwelling (comfort and health of the occupant) and at the same time, its energy and environmental performance;
- **Macro scale:** considering the building in its immediate environment, to benefit from the advantages of that environment and improve its failings

The sustainable housing renovation process consists of:

- starting from an existing building and its context
- analyzing the advantages and disadvantages of the existing building and its context
- improving the situation, with regard to:
  - its relationship to the neighbourhood
  - the comfort of its indoor areas
  - the comfort of its outdoor areas
  - its energy consumption

And it is clear that each context also has a potential for improvement which depends on:

- proximity of services (works places, schools, shops, ...)
- possibility of connection to urban networks
- access to public transport
- proximity of parks and places for relaxation

### 4. OCCUPANTS' PARTICIPATION

Sustainable renovation of an apartment building or a single-family home does not determine a new lifestyle, but it contributes to the realization, more or less rapidly, that the future of the planet depends on a certain number of actions to be undertaken, both as concerns energy and the environment.

When renovating individual or collective housing, the designer must make a certain number of choices in order to significantly improve energy and environmental performances of the housing.

However, if the housing is to reach the maximum performance for which it was renovated, the occupants must understand, accept and adopt certain behaviour patterns, particularly as concerns their consumption (heat, lighting, water, ...).

Clearly, the acceptance of these new behaviour patterns – and consequently their adoption – will be facilitated if the future occupants are known and associated with the reflection on energy and the environment as early as possible, and also with the renovation programme.

For these reasons, certain essential themes, like water consumption and sorting and collection of household waste, should be covered in an information and awareness campaign during the design and renovation phase for the housing.

In addition, involving the occupants and explaining their responsibility with regard to the proper operation of the various sys

tems and/or techniques integrated in the housing also makes it easier to require occupants to control their consumption and to verify maintenance of the systems installed.

For this reason, information on the various systems and/or techniques integrated in the housing unit and their correct usage should be given as soon as the housing is occupied. It is also advantageous to offer occupants a guide for the use of the housing, as soon as they enter it, and to give them the particulars of a contact person should they need more technical information.

### 5. RENOVATION STRATEGIES

In terms of sustainable development, the first question that arises concerns both:

- the extent of the works to be carried out;
- the consumption of energy and materials needed.

#### 5.1. Heavy housing renovation

The idea of heavy renovation consists exclusively of maintaining the existing structure of the building.

This type of renovation therefore implies a new design of the envelope, the lay-out of the rooms and techniques associated with comfort, but also waste management during demolition and renovation works.

Heavy renovation will require:

- considerable consumption of grey energy,
- considerable consumption of materials,
- considerable production of waste.

This type of renovation is by and large associated with new constructions and often, despite the significant extent of the works to be carried out and the budget, allows for a radical improvement of the energy and environmental performance of buildings.

#### 5.2. Light renovation

The concept of light housing renovation consists of working in priority on the interior layout of the building; modifications of the shell being reduced to a minimum.

This type of renovation therefore means maintaining the way the rooms are disposed, the size of the rooms, the relation between them and access to them.

Light renovation entails:

- little consumption of grey energy;
- moderate use of materials;
- limited production of waste.

This type of renovation is usually associated with rehabilitation and allows for a significant improvement in energy and environmental performance of the buildings at lower cost, without achieving the same results as a heavy renovation, nevertheless.



↑ Illustration 50 : Exemple of a large renovation



↑ Illustration 51 : Exemple of a light renovation (insulation by inside)



Devices	Large renovation	Light renovation
<b>Form and orientation</b> Building form Orientation Windows surface Windows orientation Creation of new window	Feasible Not feasible Feasible Feasible Feasible	Not feasible Not feasible Not feasible Not feasible Not feasible
<b>Envelope performance</b> Frame replacement Walls insulation Roof insulation Air tightness	Feasible Feasible Feasible Feasible	Feasible Feasible Feasible Feasible
<b>Systems and technics</b> Installation of air renewal Improvement in heat production Drinking water network and facilities Recovery and use of rainwater Optimization of hot water production Solar thermal and photovoltaic energy	Feasible Feasible Feasible Feasible Feasible Feasible	Not feasible Feasible Feasible Not feasible Feasible Feasible
<b>Works on outdoor spaces</b> Management of rainwater on the parcel Choice of covering material Greenroof	Feasible Feasible Feasible	Feasible Feasible Not feasible
<b>Quality of live</b> Mixing functions Social diversity	Feasible Feasible	Not feasible Feasible

*Despite certain similarities or recurrent systems, each renovation project is a special case.  
All of the data sheets presented in this document are guidelines to be followed to reach objectives set in terms of consumption (energy, water, materials) and comfort (indoors and outdoors).*

*These guidelines remain general and must be adapted to each product in view of its specificity to obtain the optimum set by the designer or the contracting authority.*

### 6. ECONOMIC POINT OF VIEW

Passive, environmental, sustainable construction and renovation are perceived as additional financial and technical constraints, even if everyone agrees today on the importance of green, passive and sustainable construction...

It is clear and obvious that renovating a dwelling thoroughly in order to approach the passive concept is not easy to do economically nor from the practical and technical standpoints.

There are several reasons for this:

- private clients' doubts about potential additional costs associated with this type of renewal and its effects on a real increase in comfort;
- shortfalls in information, training and know-how in the building sector (architects and contractors) which inevitably entail additional costs.

However, even if one considers that renovating sustainably with advanced energy techniques in housing will cost about 10 to 15% more than traditional renovation, it is important to say that in the long term, this type of renovation is financially more advantageous.

Indeed, in the long run, the costs associated with using the housing (heat, air conditioning, electricity supply, drinking water supply and so on) will be reduced sharply, contrary to the various energy vectors which are going to increase in decades to come.

And in the long run, the real estate value of the housing will also increase as a result of its performances.

But there still is a fundamental question in terms of comfort, well-being and quality of life: is it really possible to put a figure on the «human» and «social» benefit of this type of renovation?

Can one really put a price on the pleasure of seeing children playing safely in the street?

Can one really put a price on cleaner air to breathe?

Can one put a price on social relations that we build up in our neighbourhood or our building?

Can one put a price on the pleasure of going places on foot or on a bicycle safely, while taking advantage of nearby, accessible green areas?

These are the kinds of questions that illustrate why the potential «wealth» of a sustainable construction and renovation is so hard to quantify.

The economic crisis that we are going through today should be seen as a perfect opportunity to radically change the way we think and act, putting Man, who is part of an environmental, social and economic ecosystem, at the heart of our concerns when building and renovating houses.



↑ Illustration 52: Economical point of view

## A. INCREASE THE COMFORT OF LIFE



### A.1. INCREASE THE QUALITY OF THE OUTDOOR SPACES

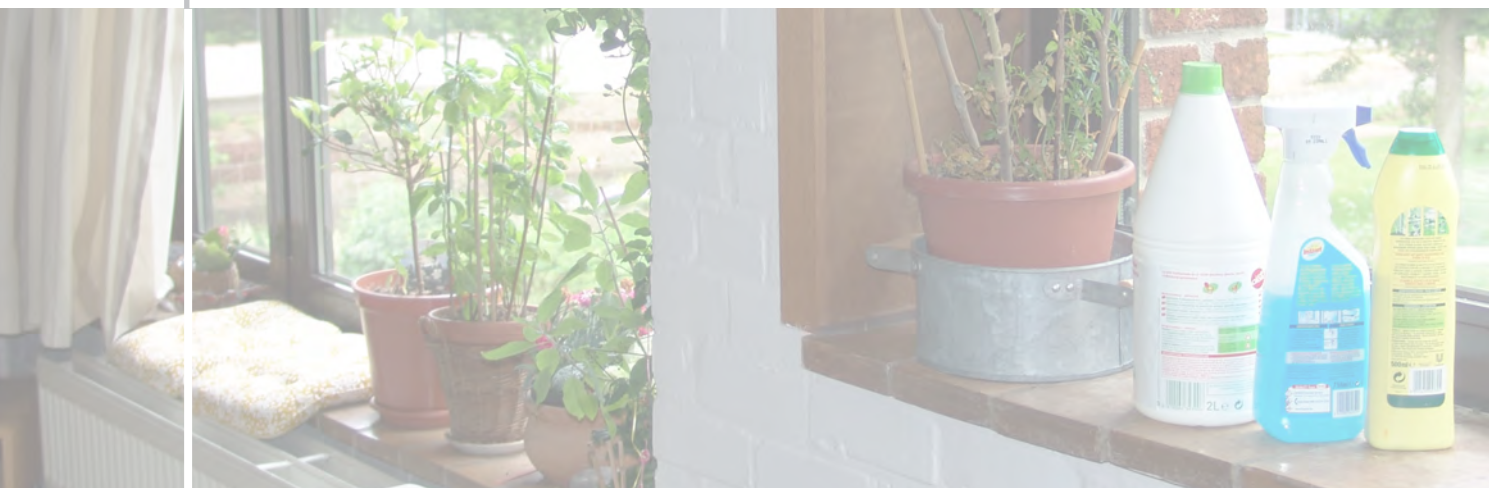

### A.2. INCREASE THE QUALITY OF THE INDOOR AIR



### A.3. THE ACOUSTIC COMFORT



## A.1. INCREASE THE QUALITY OF THE OUDOOR AREAS



A10 - Favour social interactions

A11 - Favour soft mobility

A12 - Favour and reintroduce biodiversity

*Picture from Sylvie Rouché*





## A.1. INCREASE THE QUALITY OF THE OUTDOOR AREAS

### Favour social interactions

N° of Sheet:  
**A10**  
Cross-references:  
**A11, A12**  
Appendix:  
/



Picture: S. Rouche

One of the priorities of sustainable renovation is to work on the existing dwellings in such a way as to encourage social ties and good relations between neighbours. Indeed, many housing studies have shown that social exchanges help to reinforce solidarity and social cohesion and in so doing the formation of a more sustainable society.

Without having a direct role in this, the designer can improve, even reinforce, these social interactions in designing his or her project by working on the following three concepts:

- increasing the housing density;
- increasing functional diversity;
- working on the collective areas.

#### 1. INCREASING THE DENSITY OF EXISTING DWELLINGS

Renovation that involves increasing the housing density increases the opportunities for exchanges between neighbours and members of the community whilst meeting the three major objectives of sustainable development, namely,

##### - Environmental aspect

Increased density makes it possible to avoid spatial scattering, to limit the buildings' occupation of the land, and to economise the surrounding natural resources. It also helps to reduce energy and building material needs.

##### - Social and cultural aspect

Increased density helps to produce an urban network that has the advantages of proximity for pedestrians and cyclists. Indeed, studies have proven that the viability of neighbourhood shops, services, local facilities, and mass transport depends upon there being a sufficient number of inhabitants and users in a radius that ranges from 600 metres (pedestrians) to 5 km (cyclists). This density also helps to increase social control and thus contributes to a feeling of safety.

##### - Economical aspect

Increased density helps to generate savings when it comes to networks and facilities by concentrating and superimposing supply and disposal networks. It helps to reduce heating energy needs and consumption charges.

However, to allow the social benefits that are induced by increased housing density to develop fully, it is necessary to offer each inhabitant or occupant the possibility of enjoying his or her own "secret garden" through visual and acoustic independence and technical autonomy.



↑ Illustration 53:  
Housing and offices renovation: 3 housing storeys added in wood frame

# Favour social interactions

## 2. INCREASING FUNCTIONAL AND SOCIAL DIVERSITY

### 2.1. Functional diversity

When one renovates a block of flats or housing complex, it is important as well to meet the infrastructural needs that are implicitly linked to housing. These include neighbourhood shops, services, local collective facilities, including parks and gardens and playgrounds, and proximity to mass transport networks.

Ideally, these functions will be housed on the buildings' ground floors so as to create activity and animation in public areas.

### 2.2. Social diversity

When one renovates a block of flats or collective housing complex, it is vital to be able to meet the different needs of the various social categories (families, couples, singles, the elderly, etc.). To do this, the designer must take care to include different types of dwelling in the scheme, e.g.,

- one-bedroom flats on the ground floor for the elderly or people with reduced mobility;
- two- and three-bedroom flats with or without access to a garden for couples and families; and
- one-room flats for young singles.

## 3. SETTING UP COLLECTIVE SPACES (INTERNAL OR EXTERNAL)

When one renovates a block of flats, it is vital to work on both the common and transitional areas (traffic areas, common rooms, external gangways, corridors, access balconies, balconies, terraces, and so on) and external areas (gardens and playgrounds) that are places for relaxation, exchanges, and encounters between occupants.

### 3.1. Collective spaces and middle grounds

#### - Collective space

Establishing collective areas, in addition to their functional usefulness (e.g., staircases, external gangways, corridors, building laundry rooms, and so on), allows basic social exchanges to take root. This will be encouraged all the more if there exists at the same time possibilities for group activities and individual appropriation of these common shared spaces.

The appropriation of a collective space is facilitated when the space is in direct contact, whether visually or through use, with the private dwelling space, for it then becomes an extension of the private premises.

#### - Middle ground

The establishment of transitional areas or middle grounds (terraces, balconies, pocket gardens, etc.) between public and private areas, allows the development of the numerous verbal and visual interactions that are the foundations of neighbourhood social life. These areas also increase the possibilities for social control that help to make people feel safe.

#### - Collective and transitional spaces in renovation

When renovating an individual dwelling or housing complex, the designer will take care to:

- enable people to identify the various spaces clearly by



↑ Illustration 54:  
Place des Wallons (Louvain-la-Neuve, Belgium): shops and services on the ground floor



↓ Illustration 55: Sterrenveld renovation : work on collective circulations



↓ Illustration 56: Provelo renovation: work on the collective laundry room

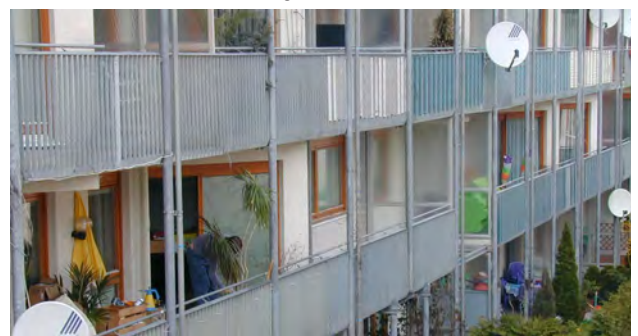

↓ Illustration 57: Brunner housing : Work on the terraces



### Favour social interactions



↑ Illustration 58: Sterrenvel renovation : work on private and collective spaces



↑ Illustration 59: Collective housing : work on private and collective spaces



↑ Illustration 60: Brunner housing: work on playgrounds

- means of architectural or plant boundaries; and
- provide middle grounds for hosting activities and harbouring various facilities.

### 3.2. Collective gardens and playgrounds

In addition to their usefulness in fostering social cohesion, collective gardens and playgrounds or areas for relaxation also make it possible to improve the building's impact on the immediate environment considerably by working on water management (see information sheet D01) and increasing biodiversity, to mention just a few points.

#### - Collective gardens

When the gardens are treated and laid out so as to enable the building's occupants to make them their own, they become true living spaces that complement the dwelling.

#### - Playgrounds or areas for relaxation

Including playgrounds in designing the external spaces also offers opportunities for exchanges: The children play, their parents chat, and ties are forged.

### 3.3. Collective spaces and sense of security

#### - Increased social control

Having the common spaces, middle grounds, gardens, and playgrounds in direct visual contact with the dwellings increases the chances of social control, which contributes to the feeling of safety.

#### - Appropriation of the space

Appropriation of the common spaces, middle grounds, gardens, and playgrounds by the occupants of the housing or residents of the neighbourhood:

- generates a feeling of responsibility (cleanliness, surveillance, etc.) and
- increases a social presence.

These two elements increase the likelihood of social control, which will contribute to the feeling of safety.

#### - Lighting

All too often still considered facilities serving the needs of motorists and other users of motor vehicles only, artificial lighting must be designed above all to meet the specific needs of "soft" modes of travel and to foster social activities in public or collective spaces in the evening.

Despite its technical aspects, the street lighting must make it possible to:

- create a feeling of safety and enhanced comfort amongst the collective spaces' users;
- foster a friendly environment and enhance the attractiveness of collective spaces at night so that they also become places for "nighttime sociability"; and
- create links between the building, its external collective spaces, and the neighbourhood or downtown area.





## A.1. INCREASE THE QUALITY OF THE OUTDOOR AREAS

### Favour soft mobility

N° of Sheet:  
**A11**  
 Cross-references:  
**A10, A12**  
 Appendix:  
 /

Today, in renovation and housing start-ups alike, one can no longer limit oneself to increasing the energy performance of housing and tertiary sector buildings without taking account of the need to optimise the urban transport networks and “soft mobility” networks that connect them.

Indeed, car traffic is one of the main sources of annoyance and pollution in town: It is responsible not only for considerable noise and congestion, but also major amounts of toxic emissions (CO<sub>2</sub>, SO<sub>2</sub>, fine particles, and so on).

Even worse, however, car traffic has played the leading role in the deterioration of public spaces, decline of social interactions, and disappearance of the feeling of belonging to a local community, to one’s street, block, neighbourhood, and so on.

*It is obvious that on the scale of a sustainable renovation project of a block of flats or an individual home, the designer has no real influence over the management of travel on foot, by bike, or by car, nor on the efficiency of public transport services. However, the architecture of built-up and non built-up places can stimulate, facilitate, and increase the safety of movement of pedestrians and cyclists, who play a role in urban vitality, community activities, and the feeling of safety.*

#### 1. HOW TO REDUCE CAR USE

*As says Richard Rogers in Cities for a Small Planet, in the middle of the 20th century there were 2.6 billion individuals on Earth for 50 million cars. Over the past fifty years the global population has doubled whereas the number of cars has increased tenfold. Over the next twenty-five years the global automobile fleet is projected to reach one billion.*

The increasingly intense use of the car has had numerous impacts on both public space and social relations, on the environment in general (air quality, global warming, acidification, tropospheric ozone depletion, resource depletion, etc.), but also on the health of living beings (the combustion of fossil fuels produces toxic emissions that have more or less severe effects on the airways in particular).

Today, our use of the automobile must be reduced.

This objective cannot be achieved without:

- the strong presence of mass transport;
- urban activities that are close to each other, thereby offering opportunities for soft mobility (walking and cycling); and
- incentives, be they legal or financial, to carpool.



↑ Illustration 61 : The car involved the deterioration of public space



↑ Illustration 62 : Brussels: trams network in exclusive right of way.

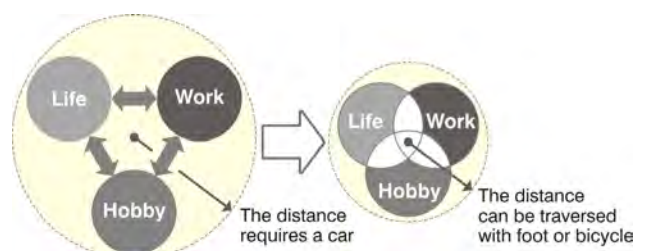

↑ Illustration 63 : Compacts areas with functions diversity decrease the need of displacement and create excited and sustainable districts

## A.1. INCREASE THE QUALITY OF THE OUTDOOR AREAS

### Favour soft mobility

N° of Sheet:  
**A11**  
Cross-references:  
**A10, A12**  
Appendix:  
/

#### 2. GETTING ABOUT ON FOOT

Pedestrian is the word for a person who walks in an urban settlement.

Outside of this context one speaks rather of walkers, ramblers, or hikers. The pedestrian is thus directly linked to the town or city, as well as to the activities that it generates.

##### 2.1. Factors that boost getting about on foot

###### - Distance to cover is less than 600 metres

A distance of more than 600 metres becomes dissuasive for the “average” pedestrian. This distance corresponds to about a ten-minute walk. Beyond this cut-off, the other modes of travel tend to be preferred.

###### - Major urban activity

Great urban activity on the ground floors of buildings that is accessible to the public and can be extended into the public space in the form of terraces is a landmark and highpoint for the pedestrian.

###### - Treatment of the middle grounds (between public and private spaces)

When these spaces are not used primarily for parking vehicles but are treated in a more varied manner, they allow many social, verbal, and visual interactions to take place.

These interactions are the foundations of a neighbourhood’s social life and the feeling of safety for pedestrians.

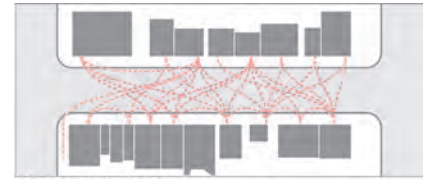

**Light car circulation**  
3.0 friends/person  
6.3 acquaintances

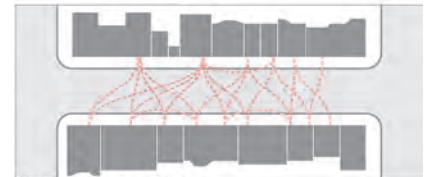

**Moderated car circulation**  
1.3 friends/person  
4.1 acquaintances

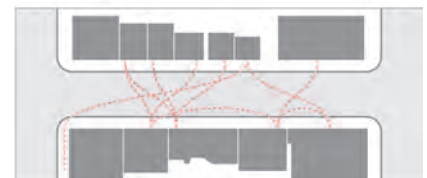

**Intense car circulation**  
0.9 friends/person  
3.1 acquaintances

Illustration 64 : Flows of the pedestrian circulation  
Source: Richard Rogers, *cities for a small planet*



↑ Illustration 65 : Brunner housing (Vienna) : bicycle sheds

#### 3. GETTING ABOUT BY BICYCLE

Getting around town on a bicycle has many advantages regarding the environment and the mobility aspects (speed, flexibility, and independence), as well as regarding health (less stress and lower risks of cardiovascular disease, high blood pressure, and diabetes; increased endurance and psychological well-being).

To encourage this means of transport on a daily basis, it is vital to provide cyclists with the following:









- **comfortable and safe bicycle paths linking their homes to their places of work, community services, and areas for relaxation;**
- **“bicycle garages” that are sheltered, secure, and well lit, located right next to housing and other activities (offices, services, etc.), and in sufficient number.**

# A.1. INCREASE THE QUALITY OF THE OUTDOOR AREAS

## Favour soft mobility

N° of Sheet:  
**A11**  
 Cross-references:  
**A10, A12**  
 Appendix:  
 /

*The following table presents some good and bad examples of bicycle «garages»*

Good examples of bicycle «garages»	Bad examples of bicycle «garages»
	
	
	
	

Source : [www.provelo.org](http://www.provelo.org)

*Some technical advices for bicycle «garages»* (Source : [www.provelo.org](http://www.provelo.org))

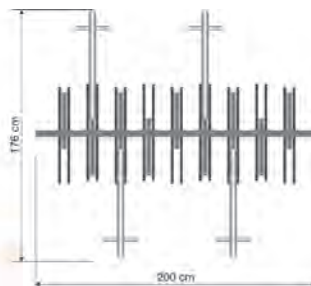
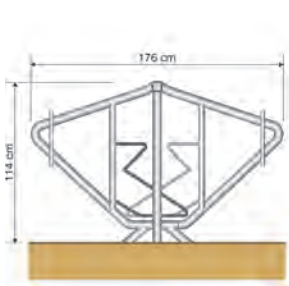





## A.1. INCREASE THE QUALITY OF THE OUTDOOR AREAS

### Favour and reintroduce biodiversity

N° of Sheet:  
**A12**  
 Cross-references:  
**A10, A11**  
 Appendix:  
 /

«Vegetation, regardless of its form (from grass to trees, from meadow to forest), is an indispensable factor in the equilibria of the ecosystems in which we live: chemical regulation, climatic regulation, water regulation, soil conservation, preservation of the fauna and flora, ...» Source : Ademe, « Qualité environnementale des bâtiments »

Setting up a planted area in an urban site, which is as a rule dense and marked by a paucity of green areas and vegetation, makes it possible to:

- reintroduce biodiversity, that is to say, a large number of animal and plant species;
- find a balance amongst the various existing ecosystems;
- create pleasant outdoor areas for relaxing, talking, and meeting people – a vital element for quality urban life; and
- create a comfortable microclimate that affords protection from heat and wind whilst improving air quality, etc.

#### 1. GREEN ROOFS

An effective way to reintroduce biodiversity in densely settled areas is to work with green roofs. A green roof is a flat or slightly pitched roof covered with vegetation and layers necessary for the vegetation's good growth. There are three types of green roofs, classified according to the type of vegetation that they support:

- extensive green roofs: virtually self-sustaining with minimal maintenance
- semi-extensive (or semi-intensive) green roofs: greater plant diversity but light maintenance
- intensive green roofs: great plant diversity and high maintenance

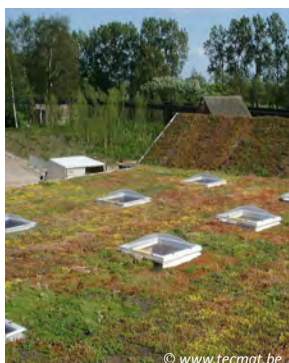

© www.tecmat.be



© www.tecmat.be



↑ Illustration 66:  
 Extensive green roof

↗ Illustration 67:  
 Intensive green roof

→ Illustration 68:  
 Intensive green roof

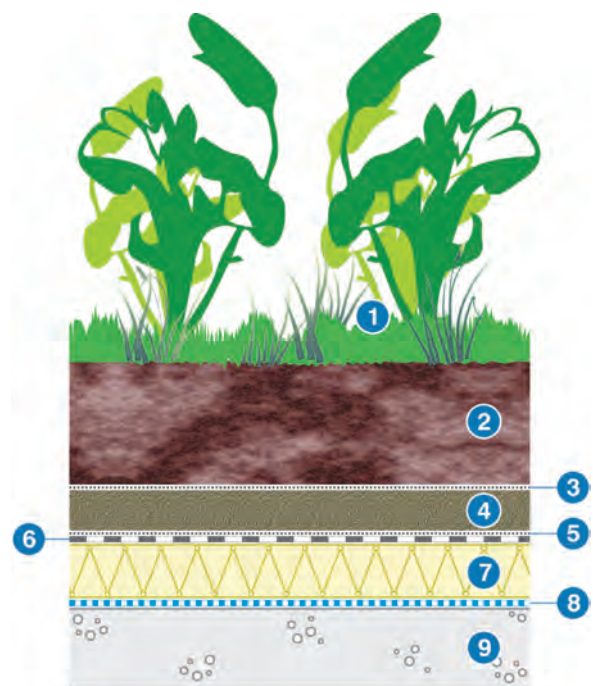

- 1 Vegetation - plants
- 2 Substrate
- 3 Filtering layer
- 4 Drainage layer
- 5 Mechanical protection of the waterproofness layer
- 6 Waterproofness layer
- 7 Thermal insulation
- 8 Vapour barrier layer
- 9 Structure

↑ Illustration 69: Various layers of a green roof

## Favour and reintroduce biodiversity

## 1.1. Advantages of green roof

**- Increased roof lifespan**

A green roof extends the lifespan of the roof's water tightness thanks to the various layers of which it is composed and its heat-regulating role:

- The watertight layer is protected from attack by the sun's ultraviolet rays and the effects of inclement weather;
- The watertight layer is subjected to smaller temperature variations, which are sources of ageing.
- The watertight layer is constantly protected from trampling and accidental impacts.

**- Reinforcement of biodiversity**

The green roof is an effective way to reintroduce a certain amount of biodiversity into an ecosystem, especially in high-density areas such as city centres, by providing animal species with corridors and living areas (for nesting or other uses) and plant species with places to grow and spread.

**- Rainwater management**

The green roof plays a preponderant role in rainwater management, especially in urban areas, which are increasingly impermeable to water, since it acts like a buffer pond between the pouring rain and rainwater discharge system.

**- Improved air quality**

The green roof increases air quality noticeably, especially in high-density areas, by filtering out some of the particles in the air, absorbing certain heavy metals (air pollution) such as cadmium, copper, lead, and zinc, and oxygenating the air through the process of photosynthesis. What is more, thanks to the phenomena of shading and evapotranspiration, the green roof improves the local air's temperature and relative humidity and the surrounding microclimate.

## 1.2. Comparative table

Criteria of selection	Extensive vegetation	Semi-intensive vegetation	Intensive vegetation
<i>In renovation</i>	yes	must be studied	difficult
<i>Thickness</i>	< 0,1m	between 0,1 and 0,25 m	> 0,25 m and according to the plants
<i>Plants</i>	Mosses, sedums, grass	Extensive and small sized intensive vegetation	All the plants of a normal garden
<i>Support</i>	flat roof or incliné 2% to 70%	flat roof or incliné 2% to 57%	flat roof 2% to 10%
<i>Structure portante</i>	Normal	must be studied	must be reinforced
<i>Overload</i>	30 to 100 kg/m <sup>2</sup>	100 to 400 kg/m <sup>2</sup>	> 400 kg/m <sup>2</sup>
<i>Accessibility</i>	no	yes	yes
<i>Overcost (including structure reinforcing)</i>	16 à 32% according to the surface area	40%	40%
<i>Impact on water cycle</i>	noticeable	important	important
<i>Impact on air quality</i>	noticeable	important	important
<i>Acoustical insulation</i>	medium	medium	reinforced
<i>Thermal insulation</i>	weak	not negligible	noticeable
<i>Implanting works</i>	simple	more complex	more complex
<i>Maintenance</i>	few or not	regular	important





↑ Illustration 70: Existing fauna and flora - Brussels area

## 2. PRESERVING THE EXISTING PLANT BALANCE

When the building slated for renovation is surrounded by planted areas, the designer shall take care not to upset their existing equilibrium.

### 2.1. Respecting existing fauna and flora

The ecosystems that exist on a renovation site must be respected by both the renovation's design and the work on the site. If there is a change in the planted area, the designer shall take care that this change is controlled properly so as to limit its impact on the existing fauna and flora.

### 2.2. Respecting the existing morphology of the plot

The changes in the planted area that are linked to the renovation must not lead to major changes in the plot's morphology: contour lines, types of soil in the upper layers, backfill, etc.

### 2.3. Respecting the ground water and the natural water flows

The changes in the planted area that are linked to the renovation must not upset the state of the ground water and natural water flows.

↓ Illustration 71 : planted area as heat protection

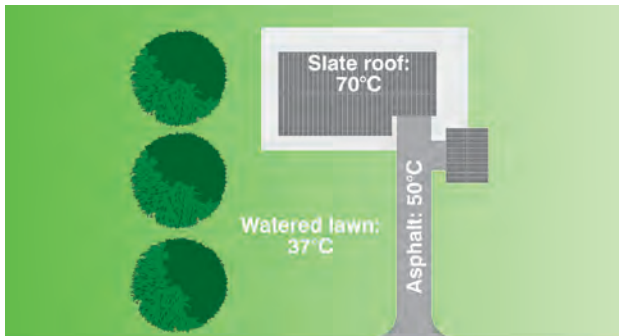

↓ Illustration 72: Planted area as solar protection

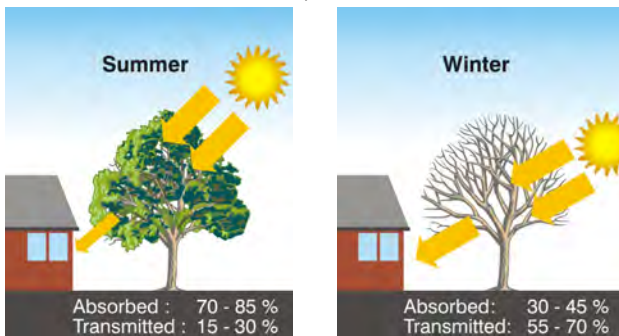

↓ Illustration 73 : Planted area as wind protection

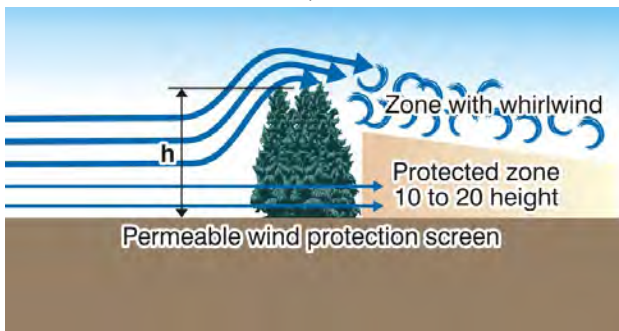

## 3. WORKING ON PLANTED AREAS

In sustainable renovation, when one has to renovate large complexes of dwellings surrounded by outdoor areas, it is vital to work with the latter by proposing a variety of ambiances. Once these outdoor areas are planted and landscaped, they will provide the following functions:

### - Protection from the sun and heat

A judiciously placed deciduous tree will offer real protection from the sun in the summer whilst letting the sun's radiation through in the winter. A planted area at the foot of the façade is a source of comfort in the summer by limiting the dissemination of radiation towards the façade, humidifying the air, and reducing the dust concentration.

### - Protection from the wind

A hedge that is sufficiently wide and high will be an excellent windbreak, especially if placed in front of openings or in places where eddies are likely to form.

### - Water regulation

A planted area (trees, hedges, flowerbeds, etc.) will limit runoff greatly and allow rainwater to sink into the ground.

A planted area adds value to the quality of life of a building's occupants whether from the visual or acoustic standpoint or in terms of general well-being. However, maintaining such areas can prove extremely expensive (mowing, pruning, and maintaining the plants), waste water (for watering), and generate huge amounts of waste.

The designer will thus take care to choose the plant species according to the following criteria:

- species that can grow in the local climate
- species that require little water
- species that require limited maintenance



## A.2 INCREASE THE QUALITY OF INDOOR AIR



A20 - Limiting sources of indoor pollution

A21 - Optimizing the ventilation system

Picture from Sylvie Rouche





## A.2. INCREASE THE QUALITY OF THE INDOOR AIR

### Limiting sources of indoor pollution

N° of Sheet:  
**A20**  
 Cross-references:  
**A21**  
 Appendixes:  
 /

*“Our lungs = an area of 90 m<sup>2</sup> in contact with about 15 m<sup>3</sup> of air every day, weighing nearly 20 kg; while daily ingestion of water is only about 2 kg and food from 1 to 2 kg”*

*Source: Guide de l’habitat sain*

The quality of air in indoor spaces can be considerably improved, in a passive way, by working on the following aspects:

- The choice of building materials
- The choice of the types of construction and details of indoor finishings
- The layout of the dwelling to favour natural ventilation
- The lifestyle of the occupants (cleansing products, maintenance of the house, etc.)

#### 1. INDOOR AND OUTDOOR POLLUTANTS

Depending on our activities, we spend 80 to 90% of our time in an indoor environment (housing and work).

The quality of the indoor environment of a building depends on many factors related on one hand to the building and its usage, and on the other to the quality of the exterior environment. Nevertheless, the majority of the pollutants present indoors come essentially from inside sources – which often makes the quality of indoor air less good than the quality of outdoor air.

##### 1.1. Outdoor pollutants and penetration in the dwelling

Outdoor pollutants are due essentially to automobile traffic, industry and heating of housing.

According to the WHO (World Health Organization), the main pollutants are as follows: carbon dioxide (CO<sub>2</sub>), sulfur dioxide (SO<sub>2</sub>), carbon monoxide (CO), nitrogen oxide (NO), ozone, hydrocarbons, heavy metals, dust.

According to the Centre Scientifique et Technique du Bâtiment [Scientific and Technical Centre for the Building Sector] (France):

- carbon monoxide CO penetrates entirely into buildings, both in the summer and in the winter;
- the quantity of particles is reduced by 20% indoors;
- indoor concentrations of nitrogen oxide NO are lower than outdoors in the summer and essentially the same in the winter;
- nitrogen dioxide NO<sub>2</sub> content is identical in the winter and higher in the summer (because of reactions between NO and ozone);
- sulfur dioxide content SO<sub>2</sub> is 40% lower indoors;
- the ozone content O<sub>3</sub> is 80% lower indoors.

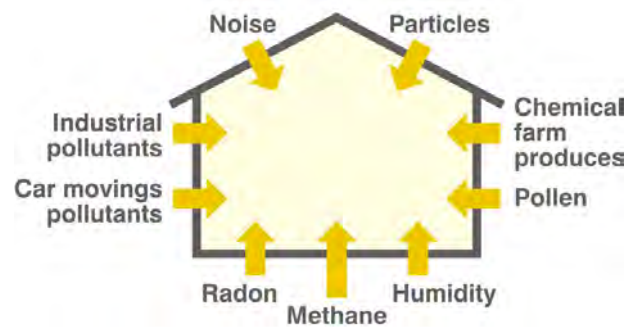

↑ Illustration 74: External pollutants



← ↑ Illustrations 75, 76 and 77:  
 The external pollutants are primarily due to the car moving, industry and housing heating

### Limiting sources of indoor pollution

#### 1.2. Indoor pollutants

There are three major families of indoor pollutants:

- bio-contaminants, like mould
- physical pollutants, like fibres
- chemical pollutants, like VOC

It should be noted, however, that among all indoor pollutants, the most significant today is still tobacco smoke. In fact, the combustion of tobacco produces benzene and tar that have a major role in the risk of contracting lung cancer.

For each pollutant, the WHO defines maximum concentration levels to prevent a health risk for the occupants. By and large these are expressed in «ppm» (parts per million), mg or  $\mu\text{g}/\text{m}^3$ .

#### 1.3. Building materials and the emission of pollutants

According to Dr. Déoux - Guide de l'habitat sain, building materials can emit pollutants in several ways:

##### - Primary emissions of pollutants

Primary emissions of materials are caused by the components of those materials. These emissions are high immediately after manufacture, and decrease by 60 to 70% over the first six months.

Generally they disappear within one year after implementation or use.

##### - Secondary emissions of pollutants

Secondary emissions are caused by the action on the material of:

- damp and alkaline substances
- high temperature
- ozone, which increases aldehyde emissions
- various chemical treatments for maintenance

This type of emission can persist and even increase over time.

#### 1.4. Humidity and indoor pollution

Humidity in a dwelling can also be considered a major pollutant. In fact, again according to Dr. Déoux:

##### - Humidity supports an organic contamination

The development of microorganisms, such as mould, bacteria, mites etc. is promoted under conditions of «food + humidity + heat».

Similarly, contamination by certain species increases with excessive humidity.

##### - Humidity increases the emissions of pollutants

Building materials can be a source of primary emissions given their specific components. The relative humidity of the air indoors increases these emissions.

Humidity also causes chemical deterioration of building materials, particularly, with the combined action of alkaline substances (example: coatings and glues in contact with concrete). These secondary emissions can intensify and last a very long time, and thus significantly affect the quality of indoor air.

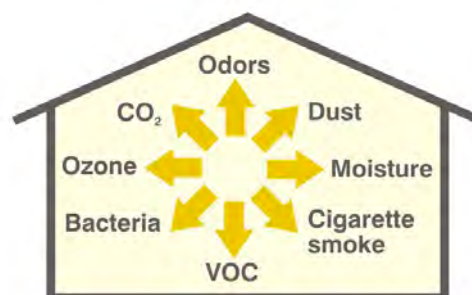

↑ Illustration 78: Indoor pollutants

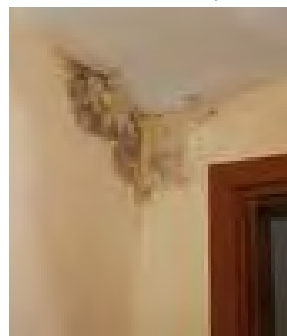

↑↓ Illustrations 79, 80, 81, 82: Toxic emissions of some building materials



### Limiting sources of indoor pollution

#### 2. LIMITING INDOOR AIR POLLUTION

Air quality in indoor areas can be considerably improved, in a passive way, by working on the following aspects:

- the choice of building materials
- the choice of the means of construction
- the lay-out of the dwelling
- the lifestyle of the occupants

##### 2.1. Choice of building materials

Choosing building materials well, essentially materials used for finishings in direct relation with the occupant and the indoor air, can both limit emissions of indoor pollutants and regulate the rate of humidity and the climate inside the dwelling.

###### - Minimizing emissions of indoor pollutants

Choosing building materials with no or little pollutants has a preponderant effect on air quality and the quality of the housing, since this choice will minimize indoor pollution of the dwelling. On choosing the materials, for a similar technical performance, the designer should select:

- finishing products or materials that limit the emission of outdoor pollutants (impact on the environment and on health):
  - production of atmospheric pollutants (greenhouse gases, acidifying gases, gases contributing to the formation of ozone, and so on) in manufacture, transport, implementation and demolition;
  - emission of toxic products
- finishing products or materials limiting emissions of indoor pollutants (impact on health):
  - materials free from particles and fibres;
  - materials free from heavy metal;
  - materials that emit little or no VOC;
  - materials that emit little or no ozone and other gases;
  - materials that emit little or no radon and ionizing rays;
  - materials that emit little or no non-ionizing rays

###### - Working with materials that breathe (perspire)

Using materials for indoor finishings that can absorb or reconstitute part of the humidity in the air without deteriorating

*Examples:*

*Clay coatings, lime coatings, insulation made from wood or cellulose fibres, particle board, ...*

##### 2.2. Choice of the building system

Careful, well suited implementation can minimize sources of indoor pollutants, particularly:

###### • Bio-contaminants:

Treatment of thermal bridges and the choice and implementation of a vapour barrier, combined with insulation can eliminate or minimize the risk of condensation and mould.

###### • Physical-chemical pollutants:

The use of mechanical fixations (screws and nails) in finishing materials avoids the use of glues and solvents.



*Some eco-labels like Natureplus label, European label and others have developed selection criteria, particularly as concerns the quality of the air and components with low emission of pollutants.*

## Limiting sources of indoor pollution

### 2.3. 2.3. Fittings and lay-out of the interior

The fittings in the interior and the distribution of the various rooms in the dwelling should be reconsidered in terms of ensuring ventilation in the areas where people live. To do so, adjustments can be made in:

#### - The lay-out of the dwelling

The designer should work on the interior lay-out so as to create draughts. This can be done using:

- a chimney effect in one-family homes
- a cross-draught effect (two facing façades) in apartments.

#### - The zones of the dwelling

The designer should envisage zones in the dwelling so as:

- to group rooms for living on one side and rooms for services (that generate pollutants) on the other
- to limit direct communication between the rooms for living and areas generating pollutants (garage, rubbish zone, boiler room, etc.).

### 2.4. Responsibility of the occupant

In terms of indoor air quality, promoting the occupants' responsibility is crucial, given their capacity to create or not to create sources of indoor pollution:

- don't smoke inside dwellings;
- choose cleansing products, laundry detergents and cosmetic products carefully;
- choose «do-it-yourself» products carefully: glues, varnish, paint, ...;
- pay attention to the decoration of the housing: rugs, furniture, plants, ...;
- manage the presence of pets.

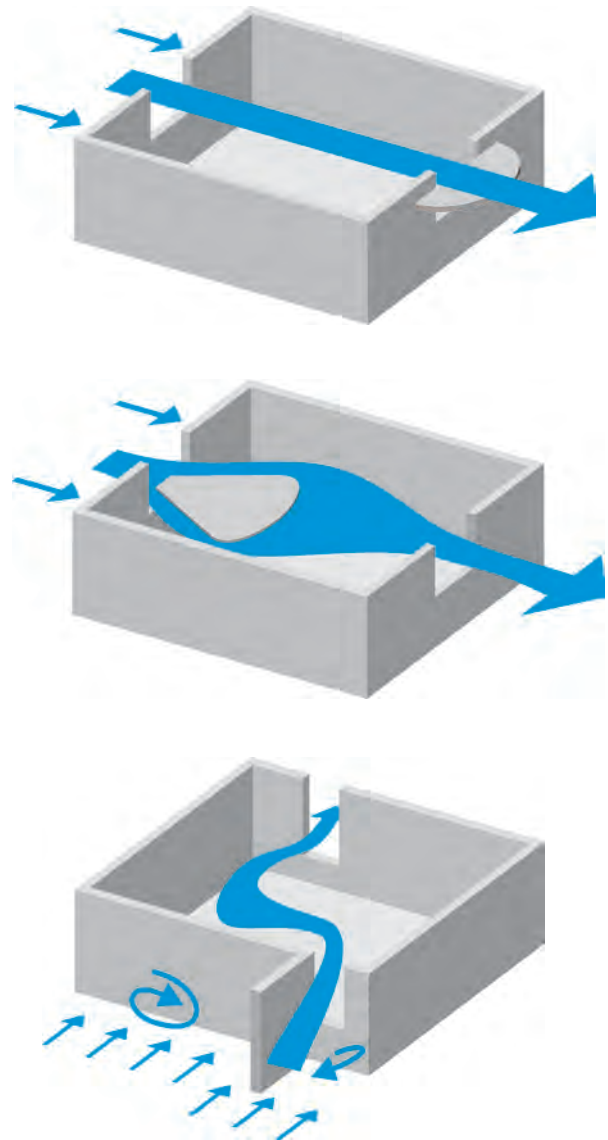

↑ Illustration 83 : Various type of air flows for natural ventilation





## A.2. INCREASE THE QUALITY OF THE INDOOR AIR

# Optimizing the ventilation system

N° of Sheet:  
**A21**  
Cross-references:  
**A20, B27**  
Appendixes:  
/

Hygienic ventilation is a system for renewing air with the following functions:

- satisfying the occupants' need for oxygen
- evacuating water vapour given off by the occupants and their activities
- limiting indoor pollution (CO<sub>2</sub> and other indoor pollutants)
- improving comfort by eliminating odours and smoke

Ventilation is particularly important when insulation and airtightness are reinforced in a dwelling. However, hygienic ventilation has high energy costs that can be as much as 50% of the energy needs of the dwelling.

Consequently, in sustainable renovation optimizing a hygienic ventilation system to combine indoor air quality and energy efficiency is crucial.

### 1. GENERAL

#### 1.1. Principle

A ventilation system:

- brings in fresh air, either naturally, or mechanically in the rooms where people live in the dwelling (bedrooms, or living room);
- forces this air through the living areas and the service areas and through the wet rooms (kitchen, bathroom, toilet, laundry room, etc.);
- extracts damp, used air from the dwelling, either naturally or mechanically.

The choice of a ventilation system will also have an impact on energy consumption of the building, since the ventilation forces renewal of indoor air (used and warm) by outdoor air (fresh but also cold).

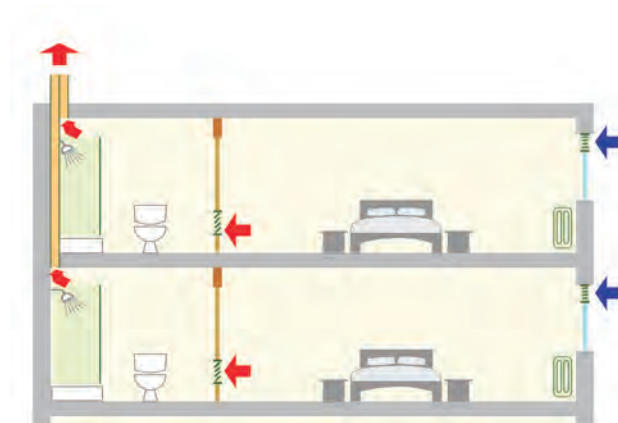

↑ Illustration 84: Principle of a ventilation system

#### 1.2. Difference between hygienic ventilation, infiltration of air and intensive ventilation day and night

It is important to differentiate between the concepts of hygienic ventilation, infiltration of air and intensive ventilation (day and night):

##### - Infiltration of air

Infiltration of air is defined as the flow of fresh air into the building through «holes» in the outdoor envelope (slits, cracks, defects in airtightness, ...).

These flows are not controlled (quantity, temperature, direction and duration) and vary considerably with the outdoor weather conditions.

In terms of a rational use of energy, the idea is to provide comfort for the occupant while limiting energy consumption. In sustainable renovation of housing, airtightness of the building will be reinforced (minimizing losses), which limits the entry of fresh air to the quantity that is necessary and sufficient to maintain quality indoor air.

##### - Hygienic ventilation

Hygienic ventilation is renewal of air needed to ensure a healthy environment for the occupants: absence of too much humidity, absence of mould, absence of dust, odours, etc. This ventilation is organized to ensure a certain flow of air in each room in the dwelling.

Consequently controllable air intake and evacuation devices must be provided (adjustable openings with correct dimensions and/or a mechanical system).

##### - Intensive ventilation

Intensive ventilation day and night is a «passive strategy for cold» which can cool a building without consuming energy. The function of the system and the air flows are significantly different from those in hygienic ventilation.

# Optimizing the ventilation system

N° of Sheet:  
**A21**  
 Cross-references:  
**A20, B27**  
 Appendixes:  
 /

### 1.3. Various type of ventilation system

In a dwelling, the combination of air intake and evacuation devices used for ventilation systems is identified by the letters A, B, C and D.  
 This information sheet simply presents the various systems and their operating methods.

**- System A - natural ventilation**

Air intake is generally done via the façade by adjustable grids. These grids supply the living premises (living room and bedrooms). The air goes through transfer openings (TO) cut in the doors (slits or grids) in damp rooms (kitchen, bathroom, laundry room) where it is evacuated by adjustable extraction vents and shifted to vertical shafts generally ending on the roof.

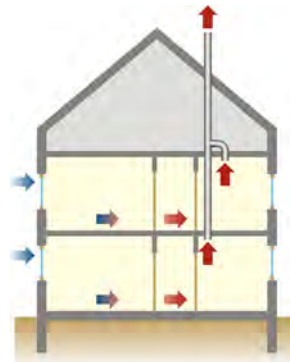

← Illustration 85:  
 System A: Natural ventilation

**- System B – simple flow ventilation (forced)**

System B, called simple flow ventilation, is a type of ventilation that is hardly used.

The air intake generally comes from the façade or the roof and is forced mechanically into the living premises (living room and bedrooms) through intake vents. The air then goes through transfer openings cut in the doors (slits or grids) in any wet rooms (kitchen, bathroom, laundry room, etc.) where it is extracted by adjustable extraction vents and transferred to vertical shafts generally opening on the roof.

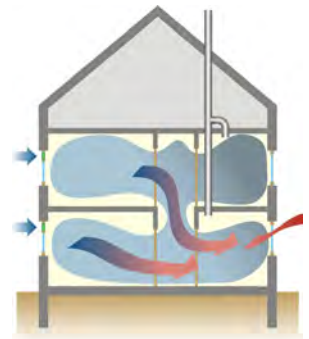
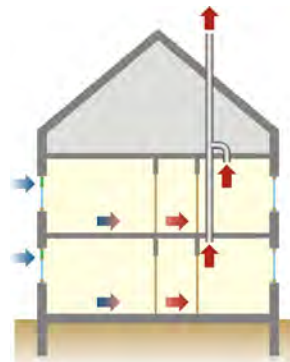

↑ Illustration 86: System B: Ventilation single flow

**- System C - simple flow ventilation (extraction)**

System C, also called simple flow ventilation, is a very common ventilation system.

The air intake generally comes from the façade or adjustable intake vents. These vents supply air in the living premises (living room and bedrooms). The air then goes through transfer openings cut in the doors (slits or grids) in the wet rooms (kitchen, bathroom, laundry room, etc.) where it is evacuated mechanically by evacuation vents to vertical ducts opening on the roof.

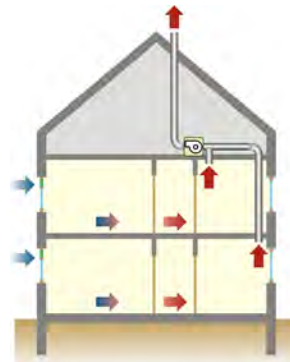

← Illustration 87:  
 System C: Simple flow ventilation

**- System D – mechanical ventilation (balance)**

System D is fully mechanized, balance ventilation. The air intake generally comes from the roof. There it is forced through adjustable openings in the living premises (living room and bedrooms). The air then goes through transfer openings cut in the doors (slits or grids) in the wet premises (kitchen, bathroom, laundry room, etc.) where it is evacuated mechanically by evacuation vents to vertical ducts opening on the roof.

This system can be combined with energy-saving devices:

- A heat recovery that exchanges the heat from polluted air to fresh air (see information sheet B26)
- A ground heat exchanger

### 1.4. Ventilation and regulation in force

Each country has its own regulation concerning hygienic ventilation of housing, particularly in terms of the air intake per square meter or per occupant and the system of ventilation to be installed.

For this reason, the designer should be well-informed about standards in force and apply them in the renovation project.

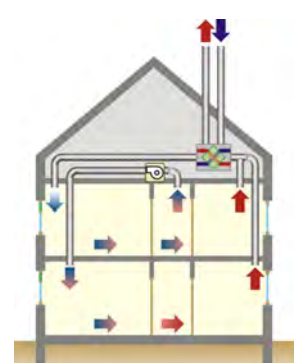
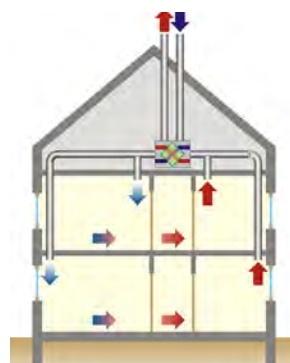

↑ Illustration 88: System D: Balance ventilation system

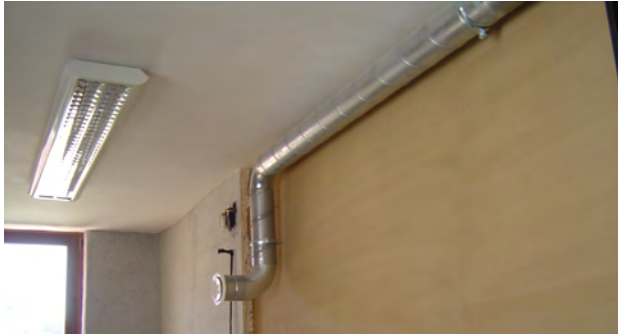

↑ Illustration 89: Installation of a ventilation system - pipes



↑ Illustration 90: Installation of a ventilation system - pipes



↑ Illustration 91: Installation of a ventilation system - grille

↑ Illustrations 92 and 93: Grilles for air intake in new frames



## 2. HYGIENIC VENTILATION IN RENOVATION

In renovation of housing, two cases are possible:

### - No ventilation system is installed

No ventilation system is present in the housing to be renovated. This is the most common case particularly for individual homes.

Attention must therefore be paid to the occupants' need for the renewal of air, possibilities for integrating ducts and technical zones, and so on.

### - A ventilation system has been installed

On renovating housing that already has an energy efficient ventilation system, one must ascertain that the existing ventilation system is suitable for the new needs, otherwise condensation or mould problems (due to damp) could appear and endanger the sustainability of the building and its air quality.

The existing installation may also be ineffective (noise, air flow, ...) and should be improved at the time of the renovation to improve thermal comfort, acoustic comfort and air quality while limiting energy consumption.

### 2.1. Setting up a ventilation system

Integrating a ventilation system is not easy in renovation, and depends to a great extent on the typology of the housing. Integration of a ventilation system should be taken into account at the design stage of the project with one prerequisite – correct airtightness of the building.

For these reasons, measures should be taken at the various phases of developing and implementing the renovation project:

#### - Preliminary project

Before choosing the type of ventilation to be integrated, certain preliminary measures are required:

- Calculating the minimum flow to be supplied to the various parts of the building
- Ascertaining that the available technical areas are sufficiently large to integrate a dual flow ventilation system, particularly in the vertical shafts and the height of the false ceilings of certain premises (halls, lobbies, ...)
- Ascertaining that there is sufficient technical space to put in a heat recovery system
- Planning the size of the ducts on the basis of an airspeed of 3 m/s

The designer must be attentive to:

- Fire safety in the case of buildings for collective housing
- Outdoor air quality and the environment in terms of sound annoyance: in a noisy polluted environment, a dual flow system is to be preferred.

The ventilation system should also be envisaged in view of other, additional parameters:

- the performance of the envelope in terms of insulation and airtightness: if the envelope is very effective, a D system can be envisaged to limit losses from ventilation
- will the window frames be replaced or not? If the window frames are to be replaced, a system can be created with an air intake in the frames

## Optimizing the ventilation system

- coupling heating with ventilation: in well insulated buildings, the power of the system needed for heating is considerably reduced. In this case, it can be logical to think of combining the heating and mechanical ventilation in a dual flow system.

At the time of the renovation of the housing, in view of the typology of the building (individual home or apartment building) and the occupants' needs, as well as the possibilities for integrating shafts and ducts, one ventilation system or another will be chosen.

### - Collective housing- apartments building

The idea is to ensure both energy efficiency of the dwellings and effective extraction of humidity. Consequently, the mechanical systems, C or D, will be given preference.

In the case of a C or a D system, the designer must also choose between two principles:

- A centralized extraction group, (for all the housing units) or a decentralized group (one per apartment)
- Central heat recovery (for all the housing units) or a decentralized system (one per apartment) in the case of a mechanical dual flow ventilation system.

### - Individual dwelling

The idea is to ensure both energy efficiency of the dwelling and the occupants' comfort while allowing for a system that can be managed by the occupants. Consequently, mechanical systems C or D, will be given preference.

### - Execution and supervision of the construction work

At the time of the design, the designer should limit friction losses for all air intake and extraction networks (max 1Pa/m of duct). To achieve this, he should:

- limit the length of ducts by placing a ventilation group in a central spot;
- prefer rigid, circular ducts with a large diameter, limiting the number of bends and connections.

### - Maintenance

All the specific features of the ventilation system, such as the air vents (in the window frames) and the various filters should be regularly maintained in order to ensure the quality of indoor air and limit friction losses.

## 2.2. Optimization of an existing ventilation system

After maintaining the existing installation (cleaning the fan and the filters), the system should be inspected to clearly identify its weak points or defects.

An existing ventilation system can be optimized during renovation work particularly with regard to the following points:

### - Improving the distribution network

#### - Making the installation airtight

Airtightness of existing ventilation networks is generally considered to be very poor.

On the other hand, in a renovation project it is hard to improve airtightness (adhesive tape, putty, ...) for an entire network, even if the latter is visible. At best, major leaks can be stopped.

The ideal solution is to completely replace rectangular distribu

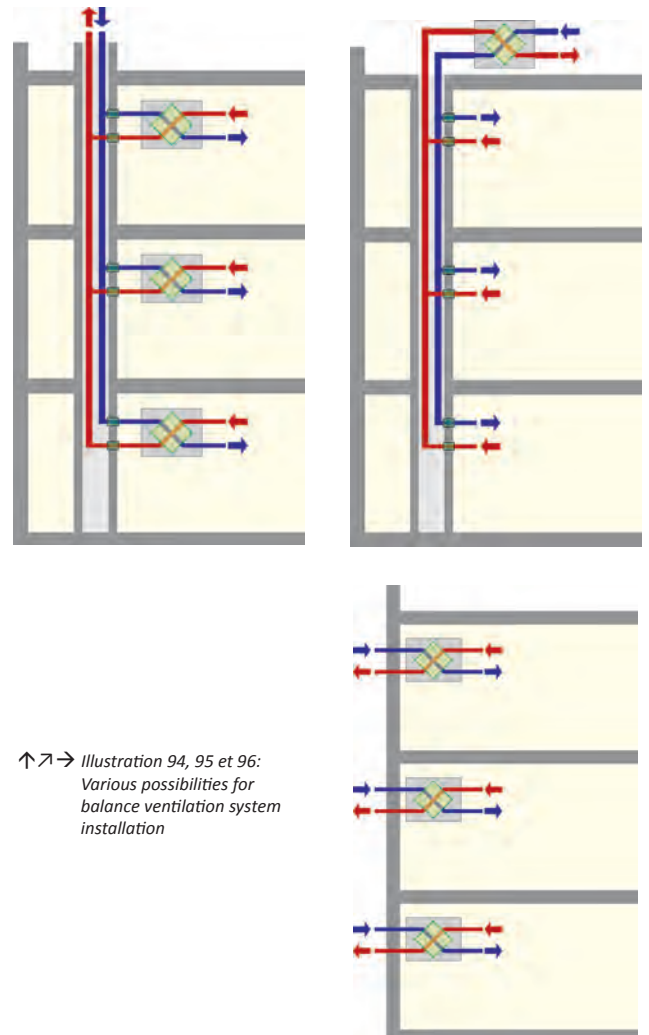

↑ ↗ → Illustration 94, 95 et 96:  
 Various possibilities for  
 balance ventilation system  
 installation

## Optimizing the ventilation system

tion shafts by circular ducts with double joints at the connections.

### - Rebalancing the installation

Balancing an installation means ascertaining that each room has the necessary flow of air, while providing for the occupants' comfort and the energy efficiency of the system.

### - Improvement of the system of regulation

#### - Management of ventilation on request

Management of ventilation on request consists of modulating the ventilation air flows in view of the occupancy of the premises. An interior sensor, CO<sub>2</sub> monitor or any such device controls either the distribution air vents or the fan speed directly.

#### - Placing the air quality monitor (CO<sub>2</sub> or VOC)

CO<sub>2</sub>, carbon dioxide is hardly sensitive to fumes from burning tobacco.

The rate of CO<sub>2</sub> is an interesting barometer for regulating ventilation and premises where occupancy is intermittent, because it represents the number of occupants and indirectly, the pollutants given off by users, such as odours. On the other hand, for premises where tobacco smoke is the main polluting agent, a «Volatile Organic Compound» (VOC) monitor is preferable.

#### HOW IT WORKS:

The measurement of CO<sub>2</sub> in the air is based on the fact that this gas absorbs infrared radiation in a given wavelength. The extent of this absorption (and consequently CO<sub>2</sub> content) is measured either by a microphone for an acoustic process, or by an infrared detector for the photometric process.

#### PLACING THE MONITOR:

Some models are suitable for placing on a wall in the room, and others are meant to be placed in the outlet shaft. The second solution is preferable for a consistent measurement of the air. A few precautions should be taken, however. The monitors should not be installed either too far or too close to the outlet grid in order to avoid deposits on the sensitive part of the probe, to avoid the risk of water condensation on the monitor, and to maintain easy access.

A monitor placed in the room:

- should not be too close to doors and windows (to avoid an influence of outdoor air),
- CO<sub>2</sub> monitors in a room should not be placed too close to people (minimum 2 m),
- should not be put in corners (poor circulation of air).

These monitors should be powered continually. Their connection to the power supply should minimize the risk of any interruption.

CO<sub>2</sub> monitors should be calibrated regularly. Once a year is generally recommended.

## 3. HYGIENIC VENTILATION AND FILTRATION OF THE AIR

### 3.1. Objectives of filtering the air

Filtration on the ventilation system eliminates polluting particles from the air:

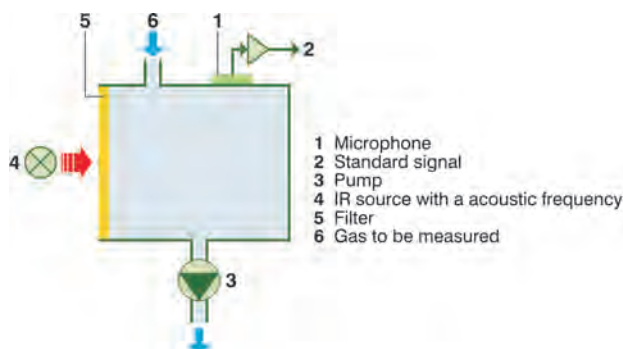

↑ Illustration 97 : Sonde CO<sub>2</sub> - procédé acoustique

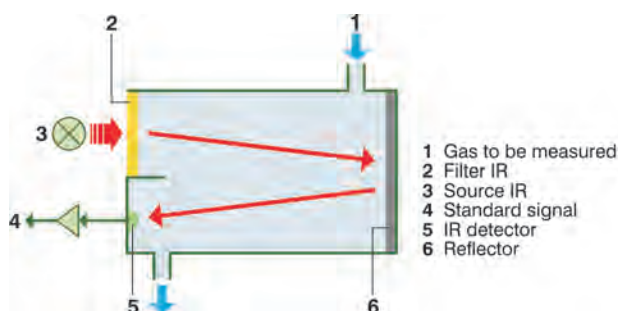

↑ Illustration 98 : Sonde CO<sub>2</sub> - procédé photométrique

## Optimizing the ventilation system

### **- Filtration of outdoor pollutants:**

The outside air introduced into the dwelling is filtered either by simply passing through a filter, or by a system of re-circulation placed inside the dwelling. Filters should be always placed in the intake or outlet of the unit otherwise dust and the pollutants will get into the ventilation unit.

### **- Filtration of indoor pollutants:**

This is done using a system for re-circulating the indoor air through a filter that increases dilution of pollutants.

The filters can be placed on the intake circuits for new outdoor air, on the air outlet circuits before recycling, on the distribution circuits of the air in the premises or on the air outlet circuits before the heat recovery system.

### **3.2. Efficiency and degree of filtration**

The efficiency of a filter is characterized precisely by a series of measurements depending on the characteristics of the incoming air: temperature and humidity, dust content and/or granulometry, type and structure of dust

#### **- Minimum degree of filtration**

Filters that are too coarse will let dust propagate throughout the installation, damaging the equipment and reducing comfort. There is a minimum level of filtration needed to protect the equipment from too much dust and to guarantee the quality of indoor air and minimum respiratory comfort.

#### **- Maximum degree of filtration**

Filters that are too effective unnecessarily increase friction losses, as well as consumption by fans for the same air supply flow.

From the energy standpoint, excessive filtering is costly (significant friction loss, reduction of flows, ... ). So the filter installation should be sized by setting a compromise that insures quality control of particles and bacteria, without energy expensive «overfiltration».

#### **- Implementation**

The effectiveness of filtration depends to a large extent on the airtightness of the assembly. The degree of filtration will fall by several classes if air bypasses the filters or if there are too many leaks.

Particular attention must be paid to the following three points:

- The filter must fill all of the space of the shaft in which it is inserted, airtight panels must close any empty space.
- When filtration is done by several filters side-by-side, an airtight joint must be placed between them. This joint must be put back in place when the filters are replaced.
- When the filter is maintained in a slide, there must be as little play as possible.

#### **- Choice of the type of filter**

Two elements affect the cost of operations associated with filtration:

- the average friction loss of the filter during operating periods and consequently the average electric power absorbed by the fan to overcome it;
- the lifetime of the filter, meaning the speed with which the filter reaches the maximum friction loss recommended by the manufacturer and must therefore be replaced.

## A.3. ACOUSTIC COMFORT

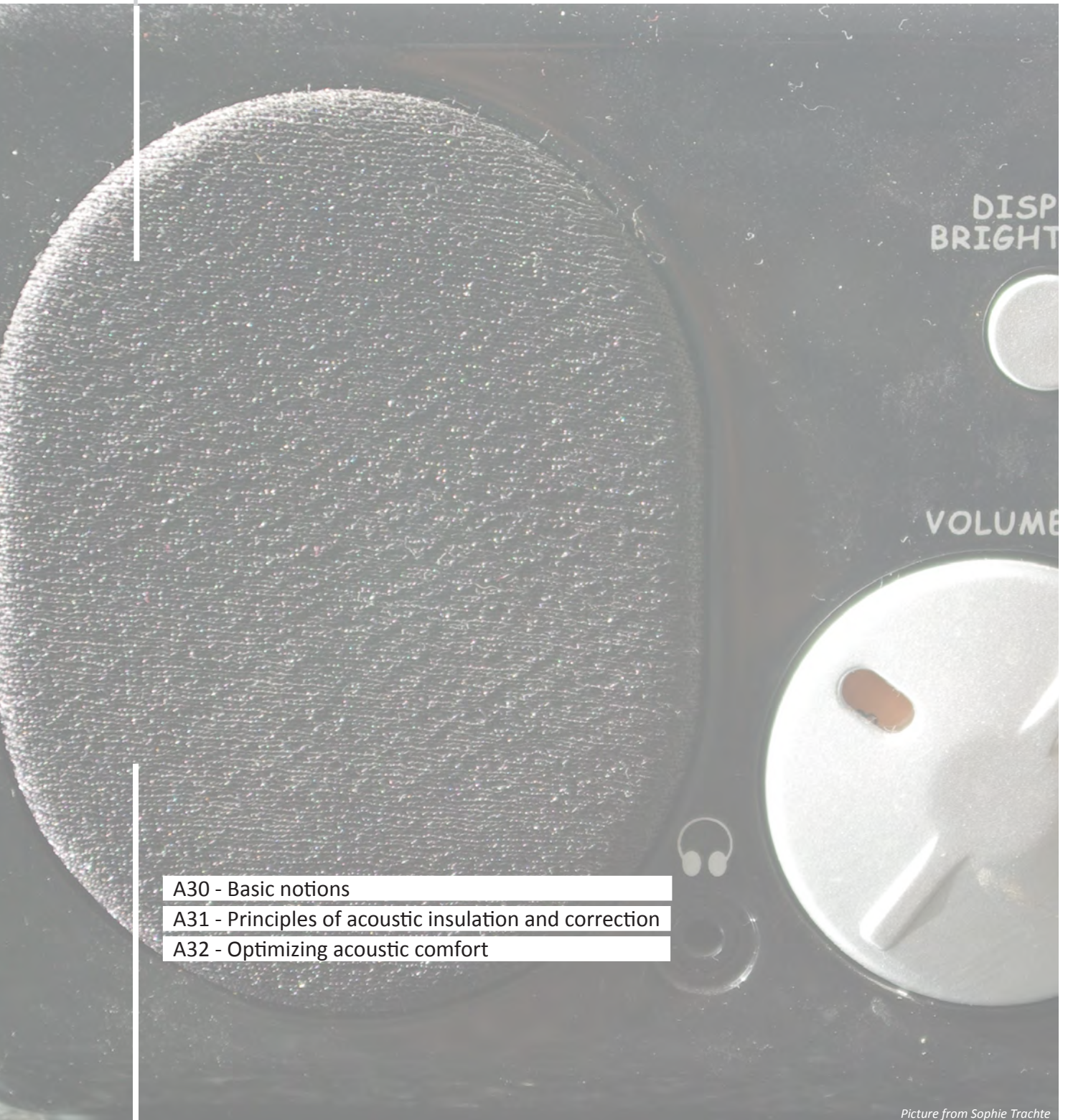

A30 - Basic notions

A31 - Principles of acoustic insulation and correction

A32 - Optimizing acoustic comfort

*Picture from Sophie Trachte*







## A.3. ACOUSTICAL COMFORT

### Acoustic : basic notions

N° of Sheet:  
**A30**  
Cross-references:  
**A31, A32**  
Appendix:  
/

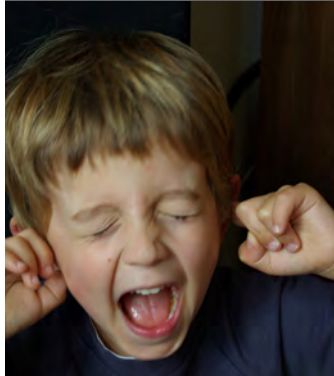

Picture: S.Trachte

Acoustic comfort is an element that is often neglected in the layout or renovation of indoor spaces. Nevertheless, it has a significant impact on the psychological balance and productivity of the occupants. Good acoustic comfort has a positive influence on the quality of life every day and on relations between users of a building. Conversely, poor acoustic comfort causes negative effects on health (nervousness, stress, problems sleeping, fatigue, etc.).

#### 1. SOUND AND NOISE

An auditive sensation is caused by the vibration of a solid body which makes air pressure fluctuate periodically at eardrum level. This variation in pressure can be represented as a sine wave that propagates in all directions from the source at variable speeds depending on the milieu of propagation (air, water, matter).

Pure sound is a vibration in an elastic milieu characterized by its frequency (height) and its amplitude (intensity).

Noise is a complex combination of pure sounds at different and multiple frequencies and amplitudes. Generally noise is associated with any bothersome, unpleasant or unwanted auditive sensation.

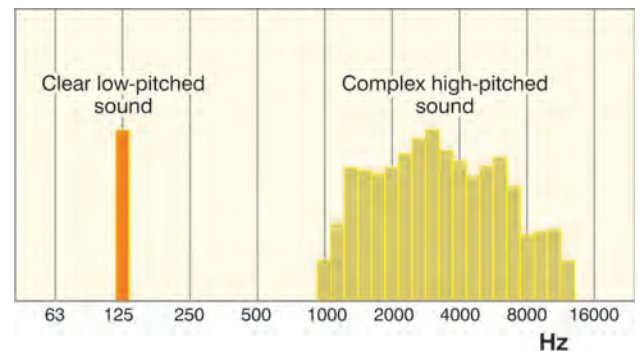

↑ Illustration 99: Illustration of various types of sound

##### 1.1. The height of the sound

The height or frequency of sound is defined by the number of vibrations per second.

Sound can be divided into three categories depending on its frequency:

- A bass or low-frequency sound (frequency less than 100Hz)
- A medium sound (frequency between 100Hz and 2kHz)
- A sharp or high-frequency sound (frequency higher than 2kHz)

In building acoustics, the relevant interval of frequencies is between 100Hz and 5kHz. Sensitivity of the middle ear goes from 20Hz to 20kHz.

##### 1.2. Intensity of sound or noise

A decibel (dB) is the unit defined to characterize the intensity of noise (sound level). A decibel is a logarithmic unit of measurement.

The corresponding unit dB(A) is a unit characterizing the way the ear perceives frequencies in a differentiated manner.

**2. PERCEPTION OF NOISE**

**2.1. Emergence**

Emergence is the quantity of noise that exceeds the ambient sound level.  
 The discomfort of emergence does not depend exclusively on the sound level, but also on the ratio of the ambient sound level and the level of emergent noise.

**2.2. Personal sensitivity**

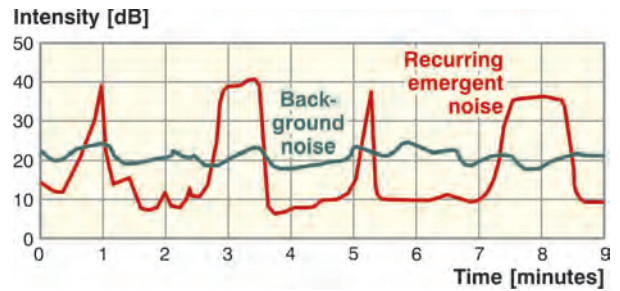

Whatever the source and origin of the noise, our ears perceive the vibrations in the air and our brain interprets the stimuli, but the same noise will be perceived differently by two people.

In fact, the perception of noise depends particularly on the state of health of the occupant (fatigue, stress, illness, ...) and the sound ambience in which the person is living (quiet apartment across from a green area, apartment along a busy street, and so on).



↑ Illustration 100: Perception of noise

**3. TYPE OF NOISE**

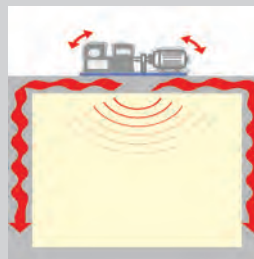
<p><b>Airborne sound</b> (indoor and outdoor)</p>		<p>Produced by a sound source. Propagation in the air around the source. An airborne noise can be produced outside or inside the dwelling.</p> <p><i>Example:</i>                  Conversation, music, airplane, traffic</p>
<p><b>Impact sound</b></p>		<p>The sound produced by an impact on an element of the building (wall, floor, ...). Propagation through that element and the surrounding air.</p> <p><i>Example:</i>                  Footfalls, the sound of a blow, the sound of an object falling on the floor, etc.</p>
<p><b>Sound of equipment</b></p>		<p>Produced by a mechanical vibration. Propagation through the elements that make up the building and the surrounding air.</p> <p><i>Example:</i>                  Sound of collective equipment: heating, ventilation, lifts, rubbish shoots, ...                  Sound of individual equipment: washing machine, toilet, faucets, ...</p>

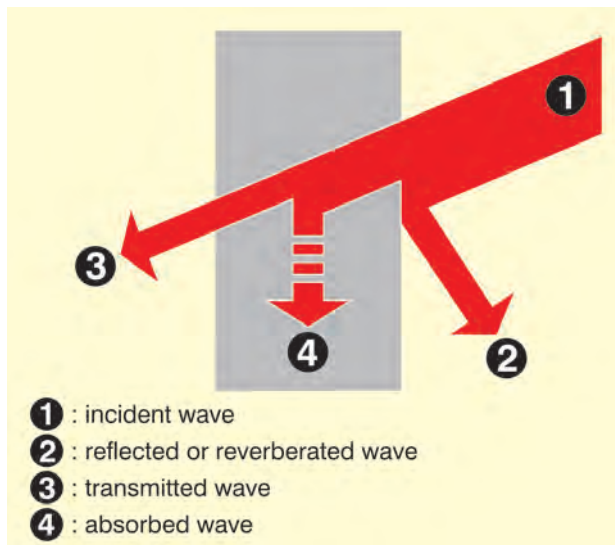

↑ Illustration 101: Propagation of noise

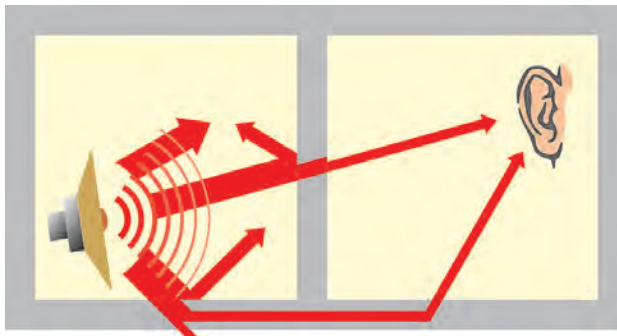

↑ Illustration 102 : Propagation of noise

#### 4. PROPAGATION OF NOISE

The propagation of a sound or noise is the path taken by the waves emitted by the sound source to reach our ears. The speed of propagation depends on the milieu in which the sound or noise is emitted; in air, the speed of propagation is 340 m/second.

When a sound reaches a surface (floor, wall, ceiling), three phenomena can take place:

- transmission of the noise through the surface (3)
- reflection or reverberation of the noise on the surface (2)
- absorption of the noise by the surface (4)

##### 4.1. Transmission of noise

Whether it is airborne or transmitted by vibrations on the surfaces of the dwelling, a noise propagates in the dwelling according to a more or less complex path between the source and the occupant's ear.

In the dwelling, noise can encounter obstacles that reduce its intensity or, conversely, phonic bridges («openings» in the construction work) that enable it to propagate more easily.

Noises are transmitted in the dwelling

- by direct transmission: through the separating surfaces (wall, floor, ceiling)
- by indirect or lateral transmission: via surfaces other than separating surfaces
- by transmission of extraneous noise: via localized defects in soundproofing

##### 4.2. Reflection or reverberation of noise

When a noise encounters a surface, part of that noise is reflected by the surface. This reflected noise then combines with the noise emitted in the premises.

This phenomenon of reflection of noise is even greater when the surfaces of the premises are heavy and rigid.

The duration of reverberation is the time -- expressed in seconds -- needed for the sound level of the premises to fall by 60dB when the sound source ends abruptly.

This is the time it takes the sound waves to subside after reflection on the surfaces of the premises.

The duration of reverberation varies with the characteristics of the premises: volume, shape and materials covering the surfaces.





### A.3. ACOUSTICAL COMFORT

## Principles of acoustic insulation and correction

N° of Sheet:  
**A31**  
 Cross-references:  
**A30, A32**  
 Appendix:  
 /

In terms of comfort and quality of life, acoustics play a crucial role, essentially in buildings of collective housing units, in high density areas like town centres and in areas where noise annoyance is high (areas around an airport, a train station, a motorway, ...).

Consequently, on renovating housing it is essential to optimize or improve acoustic insulation. To do so, the designer must take care to:

- identify and characterize any noise annoyance outside the housing
- identify and characterize any noise annoyance inside the housing
- reduce the noise annoyance (inside and outside) or limit exposure to it.
- insulate the housing from the external noise annoyance
- act on the propagation of sounds in the housing itself.

#### 1. ACOUSTIC CHARACTERISTICS OF BUILDING MATERIALS

The choice of building materials can influence sound quality in the dwelling, both as concerns sound quality in the premises and acoustic insulation due to the characteristics of the materials:

##### 1.1. Index of transmission loss of airborne noises R

The capacity of a material to prevent transmission of airborne sounds is assessed by its transmission loss index, referred to as  $R_w$  (dB).

The transmission loss index is the difference in sound levels recorded on either side of a surface or a material, between the places of emission and reception.

The higher the transmission loss index  $R_w$  of a material, the better its capacity to dampen sound.

##### 1.2. Absorption capacity

The acoustic absorption capacity of a material indicates the capacity of a material to absorb sound vibrations within its own structure.

This capacity is defined by a figure ranging from 0 to 1; the larger the figure, the greater the absorption power of the material.

##### 1.3. Specific mass

The higher the specific mass and inertia of a building material, the greater its capacity to insulate airborne noise.

##### 1.4. Thermal insulation and acoustic insulation

Given the similarity of materials used, one could suppose that thermal insulation also produces acoustic insulation, but thermal insulation will also be effective as acoustic insulation only if the structure shows open porosity (mineral and vegetal wool).



↑ Illustration 103 : Noise attenuation thanks to walls

#### Index of the aerial noises attenuation $R$ of some walls

Bloc de plâtre - 7cm d'épaisseur	35dB
Brique creuse - 20cm d'épaisseur	48 dB
Bloc de béton - 20 cm d'épaisseur avec enduit au ciment	52dB

Source: *L'isolation phonique écologique - Matériaux et mise en oeuvre*; JL Beaumier, Terre Vivante, Mens, 2006.

#### Coefficient of absorbcency according to the frequency

Materials	125	250	500	1000	2000	4000
Laine minérale 50mm - density of 100kg/m <sup>2</sup>	0.27	0.62	0.82	0.93	0.81	0.76
Panneau fibres de bois 20mm - density of 230kg/m <sup>2</sup>	0.15	0.44	0.45	0.44	0.53	0.59
Glazing of 4mm	0.03	0.03	0.03	0.02	0.02	0.02

Source: *L'isolation phonique écologique - Matériaux et mise en oeuvre*; JL Beaumier, Terre Vivante, Mens, 2006.

**2. PRINCIPLES OF ACOUSTIC INSULATION**

The expression acoustic insulation is used when measures are taken to limit transmission of noise through the dwelling by working both on elements of the envelope and structural elements of the dwelling.

**2.1. Limiting direct transmission**

To limit direct transmission through the dwelling, essentially the following principles will be used:

*- Principle of mass*

Under the law of mass, the heavier a material, the greater its power to insulate sound. The presence of mass is particularly effective in reducing airborne noise.

*- Principle of Mass - Spring - Mass*

This principle is the most commonly used in acoustic insulation. It consists of using composite walls of three layers of materials having different characteristics in order to absorb or pick up as many different frequencies or wavelengths as possible:

- 1st layer (Mass): material with high inertia – reflection of a large part of the incident wave and absorption of the rest
- 2nd layer (Spring): absorbent material – dispersion of part of the wave in the first material
- 3rd layer (Mass): material with high inertia – reflection of part of the wave in the absorbent material

**2.2. Limiting lateral transmission through structural elements**

To limit lateral transmission through structural elements, the principle of decoupling is used.

The principle of decoupling of the structural elements prevents noises from propagating by vibration through the existing structure.

Resilient materials are materials that resist the propagation of sound between two structural elements by decoupling those elements.

Materials like cork, felt made from plant fibre (cellulose-linen, hemp), foam (rubber or synthetic) are used for this.

**2.3. Limiting transmission of extraneous noise**

To limit transmission of extraneous noise, the principle of airtightness is used.

A hole, a crack, the passage of pipes, a leaky joint around the window frame, any of these can destroy all efforts at acoustic insulation of a surface. After all, if air can get in, sound can get in. Good acoustic insulation therefore requires good airtightness and maximum homogeneity of surfaces.

This airtightness must not be achieved at the expense of healthy ventilation of the dwelling, however (see information sheets A21, B17).

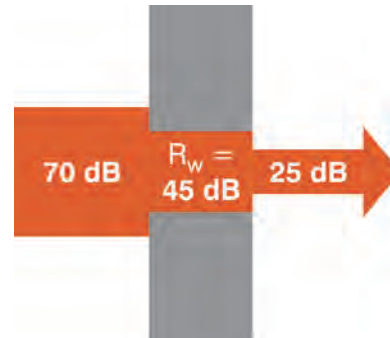

↑ Illustration 104 : Illustration of the Mass principle

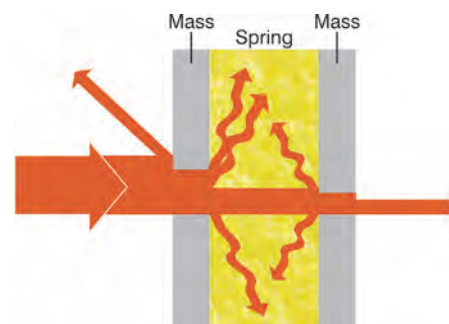

↑ Illustration 105: Illustration of the Mass/Spring/Mass principle

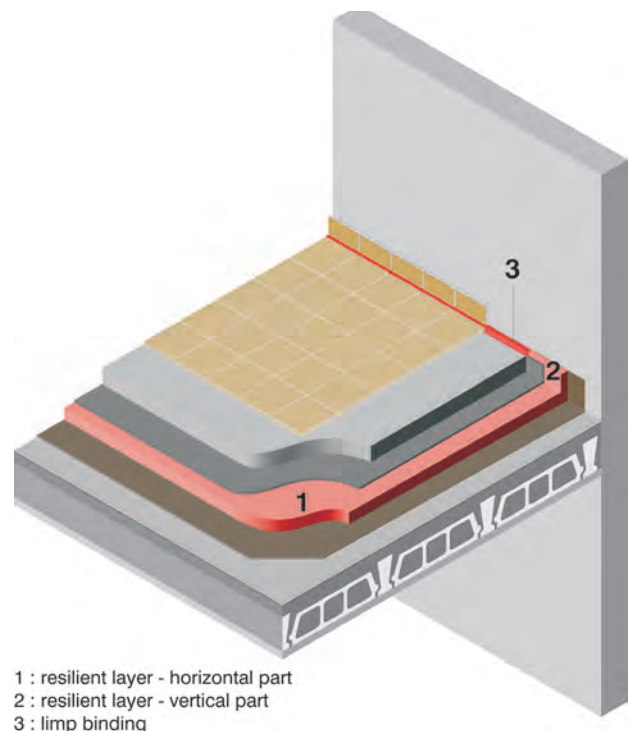

1 : resilient layer - horizontal part  
 2 : resilient layer - vertical part  
 3 : limp binding

↑ Illustration 106 : Junction between slab and wall

**3. PRINCIPLES OF ACOUSTIC CORRECTION**

The expression acoustic correction is used when modifying the indoor characteristics of premises to treat reflections of sound waves on the surfaces inside the premises where the noises are produced.

Acoustic correction also helps improve the quality of sounds perceived (improved listening conditions) and the sound atmosphere of premises without actually reducing the sound level of those premises.

In acoustic correction, the emitter (sound source) and the receiver (the ear) are considered to be in the same premises.

**3.1. Rules of acoustic correction**

The state of the surface and that of the composition of the walls (walls, floors, ceilings) of existing space to a large extent determine the acoustic characteristics.

In view of the purpose to which premises are to be put, the acoustic characteristics can be improved by working on the following principles:

**- Combining reflecting and absorbent surfaces**

According to the destination of the room, we will alternate the reflective smooth walls (reached a maximum wall) and the absorbing walls (against-partition perforated with insulator). Moreover certain accessories also make it possible to reduce the reverberation of the noise: fabrics, fitted carpet, furniture...

**- The geometry of the premises**

Depending on the purpose of the premises, certain proportions (length, width, height) will influence the acoustics.

**- Distribute the intervention surfaces all over the room (10 x 1 m<sup>2</sup> rather than 1 x 10 m<sup>2</sup>)**

Acoustic correction principles are essentially implemented in housing renovation projects in the common areas such as halls and stairways. These principles are rarely used inside dwellings except for example for medical offices, music rooms, etc.

**3.2. Acoustical correction systems**

Material / System	Absorbed frequency	Type of material System diagram
<p><b>Absorbing material</b></p> <p><i>To reduce the reverberation of the sound wave by preventing the reflexion of this one on the wall.</i></p>	<p>High frequency</p> <p>Intermediate frequency</p>	<p>Fibrous or porous materials</p> <p>According to the thickness of material</p>
<p><b>Bending panels</b></p> <p><i>To rather absorb the acoustic energy of its incident by putting the panel in vibration than the wall</i></p>	<p>Low frequency</p>	<p>Insérer SCHEMA</p>
<p><b>Soundboard</b></p> <p><i>Absorb the acoustic energy of its incident while putting moving the mass of the air included/ understood in each hole of the panel</i></p>	<p>The spectrum varies according to the bore of the panel</p> <p>Mainly low frequencies</p>	<p>Insérer SCHEMA</p>







## A.3. ACOUSTICAL COMFORT

# Optimizing acoustic comfort

N° of Sheet:  
**A32**  
Cross-references:  
**A30, A31**  
Appendix:  
/

In terms of comfort and quality of life, acoustics play a crucial role, essentially in buildings of collective housing units, in high density areas like town centres and in areas where noise annoyance is high (areas around an airport, a train station, a motorway, ...).

Consequently, on renovating housing it is essential to optimize or improve acoustic insulation. To do so, the designer must take care to:

- identify and characterize any noise annoyance outside the housing
- identify and characterize any noise annoyance inside the housing
- reduce the noise annoyance (inside and outside) or limit exposure to it.
- insulate the housing from the external noise annoyance
- act on the propagation of sounds in the housing itself.

### 1. IDENTIFICATION OF SOUND ANNOYANCE

Treating an acoustic problem in an existing dwelling begins by a diagnosis of the situation, in order to understand what is perceived as sound annoyance, where the sound pollution comes from and how it propagates in the dwelling.

In an individual home, it is fairly easy to tell whether the sound annoyance originates indoors or outdoors.

Conversely, in collective housing, identification is not always immediate and an analysis may be needed «floor by floor». If visual and audio observation are not sufficient, more advanced investigations by a specialist can be envisaged.

↓ *Illustration 107 : External noises infiltration by shutter chest*

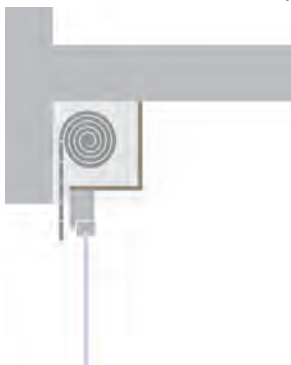

↓ *Illustration 108 : Aerial noise*

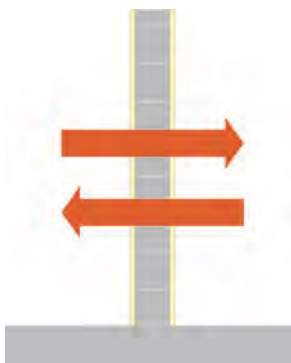

↓ *Illustration 109 : Noise of impact*



#### 1.1. Exterior sound annoyance

In most old dwellings, the walls of the façades are generally good acoustic screens, because of their large mass. However, ineffective airtightness can result in the propagation of noise inside the dwelling.

Two weak points in the envelope of an existing dwelling are:

- the windows (frames and glazing)
- added elements (shutter box, ventilation grid, etc.)

These two elements should be verified in priority to improve acoustics on renovating a dwelling in environments where the sound level is high (town centre, proximity to a railway station, airport, road traffic, etc.).

#### 1.2. Indoor sound annoyance (airborne noise or impact noise)

In old housing, acoustic weak points with regard to airborne noise and impact noise come essentially from:

- the door on the landing
- doors inside the dwelling
- shared walls and/ceilings between dwellings
- rigid connections between the floor and the walls

#### 1.3. Annoyance due to technical equipment installations

In old housing, acoustic weak points for equipment noise are essentially due to:

- shared walls and/ceilings between dwellings
- rigid connections between the floor and the walls
- common technical shafts (rubbish shoots, pipes, lifts, etc.)
- passage of pipes or ducts through a structural element (wall, floor, etc.)

**2. INSULATING THE DWELLING FROM EXTERNAL SOUND ANNOYANCE**

**2.1. Setting up sound screens**

When housing is close to a major external sound source, the designers should study the possibility of putting up sound screens (planted or constructed) that absorb part of the noise and reduce the sound intensity perceived by the occupant.

**- Indoor sound screen**

Modifying the layout of the housing by using the location of service premises to provide a screen between the external sound source and the living premises.

**- External sound screen**

Fitting out external areas or planting trees, hedges or any other plant arrangement between the sound source and the dwelling.

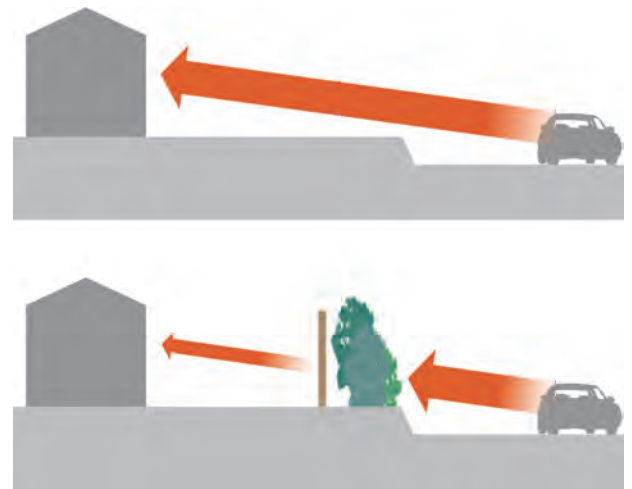

↑ Illustration 110 : Outdoor soundproofing screen

**2.2. Treatment of the envelope**

Interventions on the outer envelope for the reduction of sound annoyance mainly pertain to improving the performances of doors and windows, to improving airtightness of the shell and the surfaces of the façades and to improving the acoustic insulation of the roof.

In sustainable renovation, thermal comfort and acoustic comfort can be combined by working on the performance of the external envelope and carefully implementing the various elements that make it up.

**- Interventions on the façades**

Interventions to improve the acoustics of façades essentially pertain to the joinery work, entrance of air (vents and grids) and certain added elements (shutter boxes).

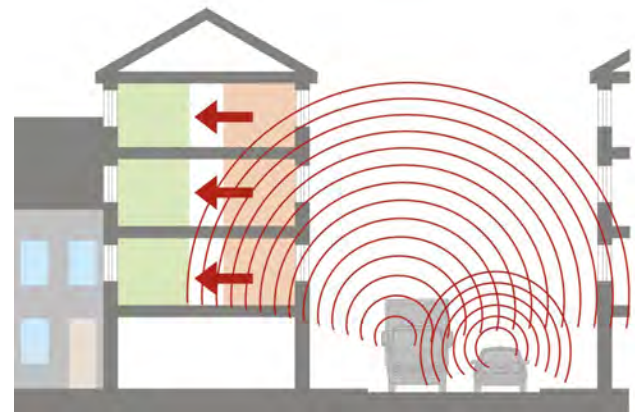

↑ Illustration 111 : Rooms repartition facing noise harmful effects

However, attention must also be given to the condition of the outer surface (coating, wooden siding, ...) and defects in airtightness.

Whatever the improvements made, particularly as concerns insulation (thermal and acoustic) and airtightness, this must under no circumstances jeopardize the ventilation of the dwelling.

**- Frame work**

The objective is both to improve acoustic insulation of the window frames by making them more airtight (eliminating any passage of air) and to make the joints between the frame and the wall airtight.

Four solutions can be envisaged:

- maintaining the frames and the glazing, reinforcing the airtightness of the whole (repairing the seals in the frame, improving airtightness where the frame meets the wall, ...)
- maintaining the frames (fixed and opening) and putting in acoustic glazing
- putting in new airtight frames with acoustic glazing
- putting in a double window in the case of historical buildings or if there are very large windows.

**- Ventilation openings**

Existing air intakes will be replaced by acoustic grids or openings that allow air to enter while significantly reducing the propagation of airborne noise.

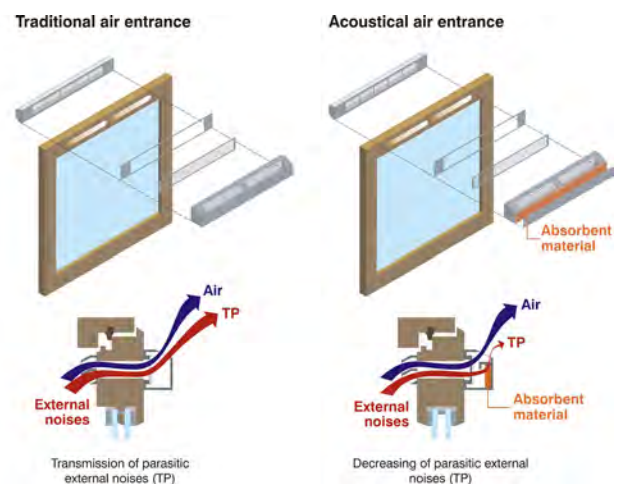

↑ Illustration 112 : Principle of acoustical air entrance

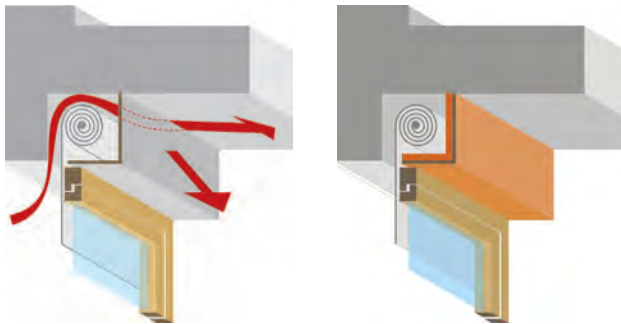

↑ Illustration 113 : Insulation of shutter chest

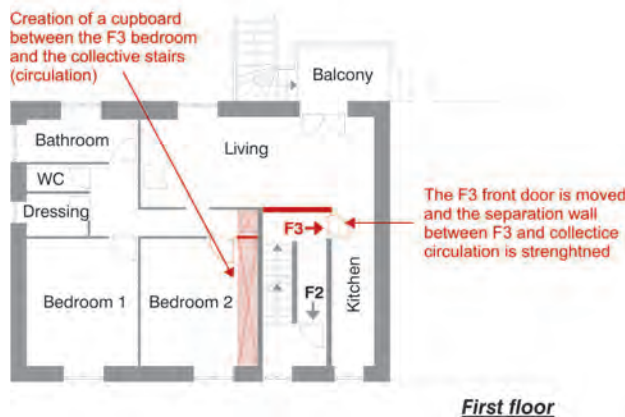
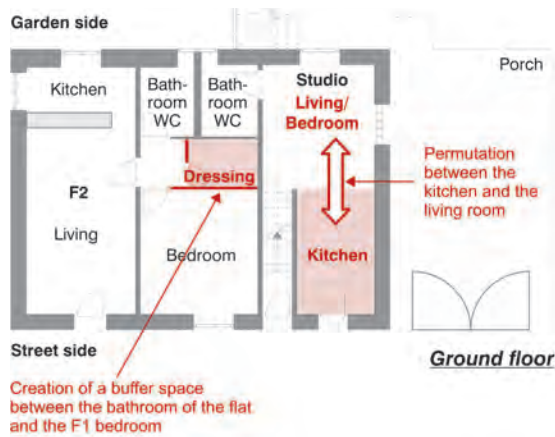

↑ Illustration 114 : Interior refitting facing noise harmful effect

**- Shutter box**

If there is a box for blinds inside the dwelling, the slot that lets the blinds roll up can also let noise in, so the frame should get special acoustic reinforcement.

**- Intervention on the roof**

Posing thermal-acoustic insulation under the roof can considerably reduce some airborne noise. However if the vibrations on the roof are transmitted to the walls and the façades, more complex decoupling solutions must be studied with a specialist.

**3. ACTING ON THE PROPAGATION OF NOISE WITHIN A DWELLING**

Noise inside a dwelling is either airborne noise or impact noise.

**3.1. Refitting the inside of the dwelling**

To limit the impact of sound annoyance inside a dwelling, the fittings and lay-out should be reviewed:

- grouping wet rooms (toilet, bathroom, kitchen)
- grouping technical premises (laundry room, boiler room, ...)
- putting bedrooms far from potential sound

**3.2. Treating separating elements**

Depending on the diagnosis made, interventions should be considered:

- in collective housing: on doors, partitions on the landing and surfaces between dwellings (wall, ceiling, floor)
- in individual housing with shared walls: on the shared walls

Few interventions are made in individual homes (houses with 3 or 4 façades), when the occupant resides in the entire house.

**- Doors and partitions on landings**

Generally speaking, the doors on landings will be replaced by acoustic doors.

When the diagnosis shows acoustic weakness of the partition on the landing (separating the dwelling from the landing), acoustic lining will be put on the partition.

**- Walls separating dwellings**

Interventions essentially pertain to propagation of airborne noise.

The intervention consists of:

- putting in acoustic lining: sound absorber + partition
- putting in a resilient layer at the bottom of the wall

**- Floors and ceilings between dwellings**

Interventions pertain both to the propagation of airborne noise and impact noise.

Transmission of airborne noise between two dwellings is often favoured by gaps where pipes go through floors and by rigid connections (metal rings or flanges) between pipes and floors.

The interventions to be made are as follows:

- filling the gaps with acoustic absorbent material
- decoupling rigid connections

# Optimizing acoustic comfort

N° of Sheet:  
**A32**  
 Cross-references:  
**A30, A31**  
 Appendix:  
 /

When airborne noise is transmitted directly through the ceiling/floor, the intervention consists of putting in an acoustic lining at ceiling level.

Transmission of impact noise (steps, objects falling on the floor) can be reduced by the following:

- using an absorbent floor covering (carpet, ...)
- putting a resilient layer between the slab and the floor covering

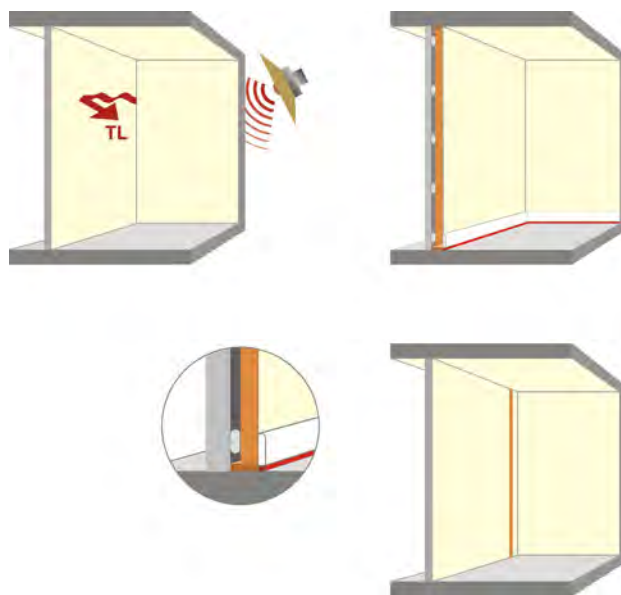

↑ Illustration 115 : Acoustical insulation of a wall

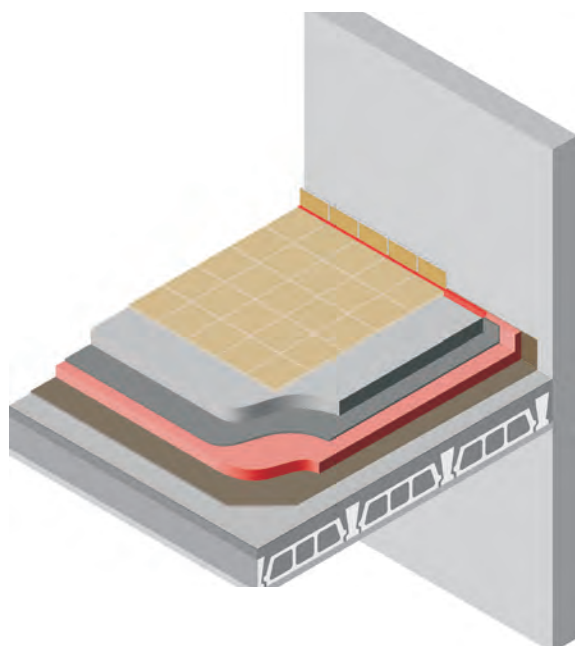

↑ Illustration 116 : Acoustical insulation of a floor

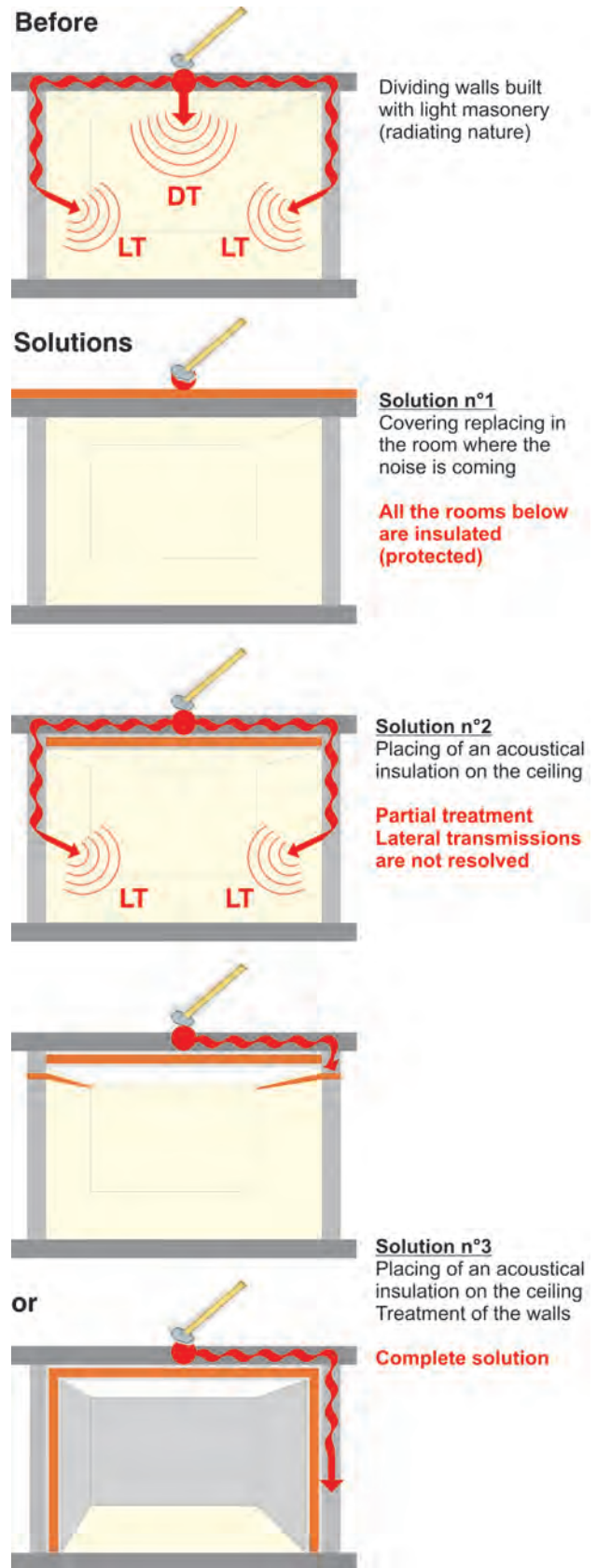

↑ Illustration 117 : Various solutions to insulate a room

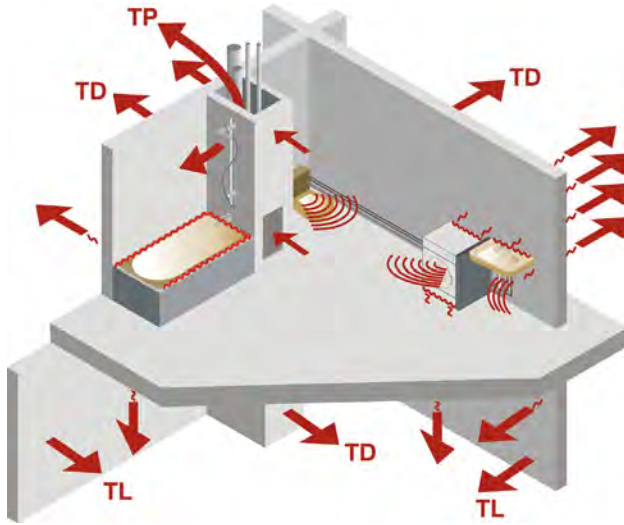

↑ Illustration 118 :  
 Various noise transmission in bathroom - due to equipments

**3.3. Treating technical equipment and installations**

Here, we will simply reproduce a series of schemes that show potential sound annoyance associated with the location of certain technical equipment or installations, and one or several solutions to solve the problem.

For the most part, these schemes can be found in the book «*Acoustique et Réhabilitation, améliorer le confort sonore dans l'habitat existant*» by Christine Simonin-Adam, Eyrolles publishers.

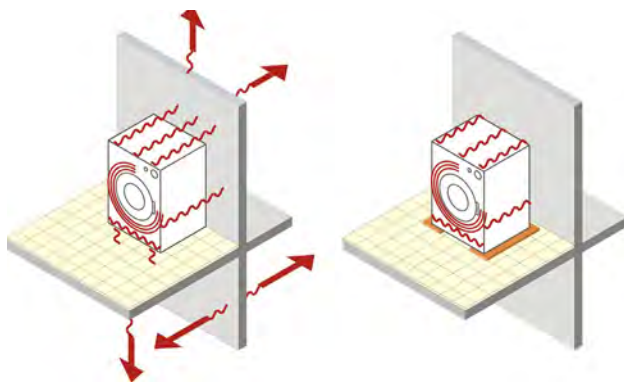

↑ Illustration 119 : Problems and solution for the washing machine



↑ Illustration 120 : Solutions for the bath

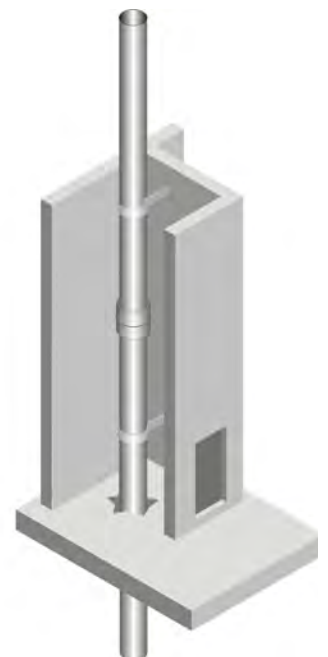
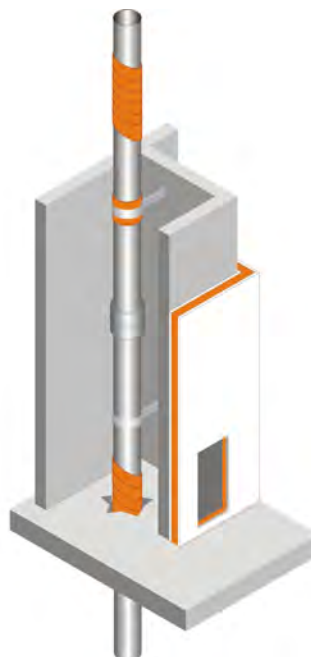
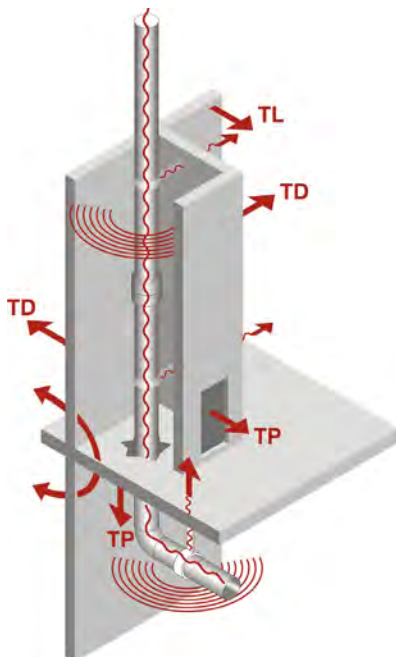

↑ Illustration 121 : Problems and solutions for pipes network



## B. REDUCE ENERGY CONSUMPTION



### B.1. INCREASE THE THERMAL PERFORMANCES OF HOUSING



### B.2. REDUCE FOSSIL ENERGIES CONSUMPTION





## B.1. INCREASE THE THERMAL PERFORMANCES OF HOUSING

- 
- B10 - Optimizing the external walls performance
  - B11 - Optimizing the shape and the sunlighting
  - B12 - Additional insulation in housing renovation
  - B13 - Improving the air tightness
  - B14 - Reducing the thermal bridges
  - B15 - Thermal inertia in housing renovation
  - B16 - Optimizing the solar protections
  - B17 - Natural nightcooling
  - B18 - Optimizing the window conception
  - B19 - «Passivhaus» standard in housing renovation

*Picture from Architecture et Climat*





## B.1. INCREASE THE THERMAL PERFORMANCES OF HOUSING

### Optimizing the external walls performances

N° of Sheet:  
**B10**  
Cross-references:  
**B11 to B19**  
Appendix  
/

Renovated dwellings must offer comfortable temperatures in winter and summer alike. As a rule, these notions of comfort are associated with heating, air conditioning, and ventilation techniques, all of which use energy. When it comes to sustainable energy renovation, the first priority is to minimise these needs (for heat, cold, etc.) by designing the envelopes and interiors of the units to renovate so as to ensure energy efficiency.

To do this, one must focus first and foremost on:

- a heat strategy
- a cold strategy
- a natural lighting (daylighting) strategy

#### 1. PRINCIPLE

For sustainable renovation, optimising the building's envelope is a primordial issue.

Indeed, the envelope is not just the boundary between the outside world and living space. It also shields the dwelling from a changing and sometimes uncomfortable outdoor climate (wind, snow, rain, etc.) so that the indoor atmosphere remains comfortable.

For good performance, the outer envelope must make it possible to:

- take advantage of the favourable outdoor elements by working on the orientation, location, arrangement of areas (see information sheet B11), and the participation of plants; and
- protect oneself from unfavourable elements (wind, cold and frost, rain, and so on).

The optimization of the envelope makes it possible to obtain an interior comfort, of day like night, summer like winter, by limiting the requirements in energy.

With this intention, the envelope must at least fulfill the following requirements:

- reducing heating needs in winter;
- avoiding overheating and the use of air conditioning in summer; and
- ensuring virtual energy autonomy in between.

However, in addition to its thermal performance, the envelope must also afford visual comfort (views and amount of daylight) and acoustic comfort (barrier against noises from outside). That is why we shall also cover daylighting strategies in this information sheet.

Acoustic comfort, for its part, has its own chapter (see Chapter A3).



Illustrations 122, 123, 124:  
External walls = protection  
against the adverse climate elements  
(rain, freeze, wind...)

**2. HEATING STRATEGY**

The heating strategy makes it possible to guarantee winter comfort whilst limiting heating needs. It is a bioclimatic principle that embraces several complementary concepts, as follows:

**- Capturing free heat**

Capturing free heat means working on both the orientations and dimensions of the building’s openings. The principle is to have broad openings to the south and smaller openings in the other directions.

**- Storing this heat in the dwelling**

Storing the heat means working with large amounts of inertia, both in the floor slabs (on the ground and upper storeys) and in the interior walls. Inertia lets you damp the temperature peaks (of cold or warmth) and in so doing limit your energy needs (heating and/or air conditioning).

**- Keeping the accumulated heat whilst ensuring good indoor air quality**

Keeping the accumulated heat means that you will have to both:

- reinforce the envelope’s insulation and air tightness; and
- keep the thermal bridges down to a minimum.

**- Distributing the heat effectively**

This means working on the interior’s layout and composition so as to distribute the heat correctly in the dwelling.

**3. COOLING STRATEGY**

The cooling strategy guarantees summer comfort whilst limiting the use of air conditioning. It is a bioclimatic principle that embraces several complementary concepts, as follows:

**- Protecting oneself from solar heat gain**

In the summer, the temperature difference between the inside and outside can be great, and the contributions of the sun’s rays (“solar gain”) can be considered thermally unfavourable.

One will thus try to protect oneself from them and prevent them penetrating inside the dwelling by placing sunscreens on the windows that face south and west. These sunscreens can be either shade plants or man-made protective structures.

**- Avoiding overheating**

Avoiding overheating means that one will work on the following two fronts simultaneously:

- reinforced wall insulation so as to limit heat exchanges between the indoor and outdoor atmospheres; and
- major inertia, both in the floor slabs (on the ground and upper storeys) and in the interior walls so as to damp the temperature peaks during the hottest times of the day.

**- Dissipating the stored heat**

Dissipating the heat that has been stored over the day means that one will work on both

- the possibility of installing intensive night ventilation and
- the outside layout (vegetation) so as to cool the outdoor air around the dwelling.

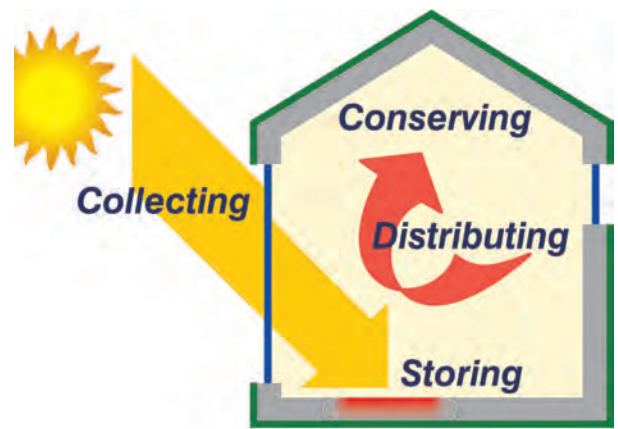

↑ Illustration 125 : Principles of heating strategy

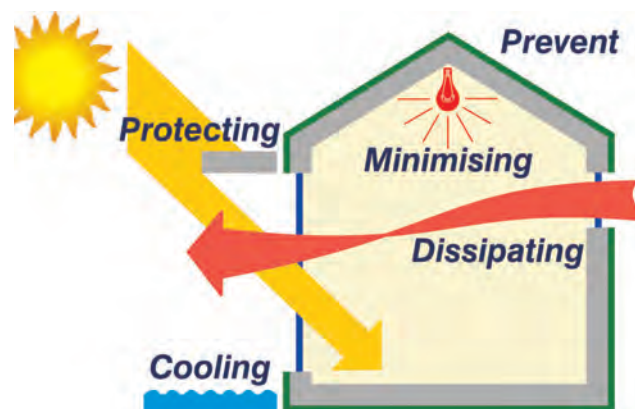

↑ Illustration 126 : Principles of cooling strategy

**Characteristics of Northern countries:**

**Heating strategy :**

Northern countries do not really need large windows facing south. After simulations, they conclude that the orientation does barely not effect on the heat load or energy needed for space heating.

**Cooling strategy:**

The use of intensive ventilation during nighttime is not needed in colder climate. They usually have a lower air flow rate during nighttime.

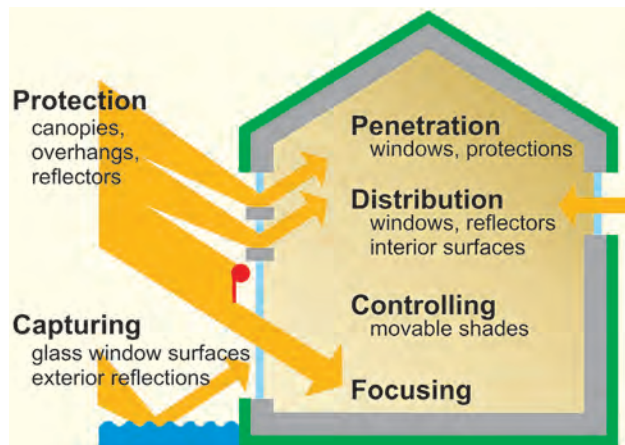

↑ Illustration 127 : Principles of daylight strategy

#### 4. DAYLIGHT STRATEGY

The notion of comfort in the home also depends on the quality of light and luminosity of the indoor areas. This quality and luminosity come from the right match between the activity for which the room is designed and the quality of the light that enters the room.

In sustainable renovation, *preference should be given to making maximum use of daylight so as to reduce the use of artificial lighting greatly*. To do this, one must implement a daylighting strategy.

The lighting strategy embraces several complementary concepts, as follows:

##### - Capturing a maximum amount of daylight

Daylight is neither fixed nor always present in the same amount, quality, and intensity. The amount of daylight that enters a building depends on numerous factors linked to the geographic location and physical environment of the building, the different times of day and seasons, but also the types of openings in the building (orientation, slope, and dimensions).

##### - Transmitting daylight into the dwelling

Transmitting daylight into the dwelling means that one will try to get as much daylight as possible to enter the building. This is done by working on both

- the windows' characteristics and
- the interiors and layouts of the rooms.

##### - Distributing the daylight in housing

Distributing the daylight in housing consists in creating a good distribution of daylight in the dwelling.

The harmonious distribution of daylight in a dwelling will be enhanced by:

- the distribution of openings;
- the arrangement of the interior walls;
- the materials used for the interior finishing; and
- the colours of the paint

##### - Protecting oneself from daylight

Protecting oneself from daylight consists in blocking all or part of the incident sunlight when it interferes to a certain extent with the use of a room.

In the case of visual comfort, this consists for the most part in protecting oneself from glare when the sun is low on the horizon and its rays penetrate deep into the room.

This screening from the sun's glare can be achieved in particular by interior or external blinds.

##### - Controlling daylight

Controlling daylight consists in managing the amounts and distribution of light in a room in line with weather conditions and the occupant's needs.

A detailed information sheet on optimising windows is given in this guide (see information sheet B18).

**5. RENOVATION AND PERFORMANCE OF THE ENVELOPE**

**5.1. Thermal performances**

When it comes to the envelope’s performance, advanced sustainable housing renovation means that one aims for the passive standard, even though it will not always be achieved, so as to minimise the heating and air conditioning needs.

Generally speaking, renovating the outer envelope in a temperate climate will have to meet the following requirements:

- for the cold period, one must promote free heat sources and reduce heat losses whilst allowing sufficient renewal of the indoor air;
- for the hot period, one must reduce the influxes of heat and promote cooling; and
- for the periods in between, the envelope must be able to adapt to what is needed through a combination of the requirements given in the first two bullet points.

To do this, to the extent that this is possible (financially and in terms of ease of implementation), the following rules must be observed:

- Exterior sides of the envelope (solid parts of the envelope: walls, foundation slab, and roof) must have reinforced insulation and seals that are as continuous as possible (see information sheets B12, B13 and B14);
- Openings (glazed areas of the envelope) must be redesigned and rescaled according to their orientation with at least low-emissivity clear double glazing and high performance frames<sup>1</sup> (see information sheets B18);
- The openings that face south, east, and west must be protected effectively (see information sheet B16);
- The foundation and floor slabs (upper storeys) and, to a lesser extent, the interior walls must exploit the principle of inertia (see information sheet B15);
- A hygienic ventilation system must be included so as to ensure sufficient renewal of the indoor air<sup>2</sup>;
- The interior layout and finishings must ensure both good heat distribution and intensive ventilation at night (see information sheet B117);

**5.2. Visual comfort**

When it comes to visual comfort, advanced sustainable housing renovation means that one will work with the following parameters:

- the views of the outside;
- the degree of illumination in the room;
- the harmonious distribution of light;
- the absence of bothersome glare and/or shading.

However, visual comfort depends on physiological and/or psychological parameters linked to the occupant and parameters specific to the environment in which the dwelling is located (possibilities of views, quality of what can be seen, etc.) over which the designer has little or no control.



↑ Illustration 128 : Thermal performances of triple glazing



↑ Illustration 129 : Importance of the insulation

↓ Illustration 130 : Visual comfort - interesting sight to outside



↓ Illustration 131 : Visual comfort = harmonious repartition of light



1 Note that the triple glazing is needed in the Northern Europe to achieve «the low energy consumption» standard  
 2 Note that the northern countries need a ventilation system with a high performance heat exchanger

**1. DURABILITY OF MATERIALS**

Renovating a dwelling with the aim of improving the envelope’s energy efficiency must try not only to improve and optimise the performances of the structure’s casing (insulating, air tightness, etc.) and reduce its weak points (thermal bridges, infiltrations of air, etc.). It must also take account of the lifespans or durability of the materials and compositions that are implemented in the process.

*“...laboratory ageing tests are effective conducted to gauge materials’ durability, but it is much more complex to make any commitments about the durability of their performances once they are implemented under the true conditions of the worksite and subject to the vagaries of the places’ use...”*

Source : “La conception Bioclimatique” S.Courgey et JP Oliva

It is important when choosing building materials to make certain that they will continue to meet design performance levels long after they are implemented.

*Example:*

*In some applications, mineral wool insulation can lose up to 50 % of its insulating ability after 15-20 years.*



↑ Illustrations 132 and 133 : Durability of the insulation thermal performances



↑ Illustrations 134 and 135 : Durability and maintenance of external coating

**2. MEASURES CONCERNING THE QUALITY OF WORKMANSHIP**

*« The choice of building materials and techniques does not hinge only upon their technical and environmental performances. It also depends upon the possibility of implementing them appropriately. Indeed, inappropriate or sloppy placement can wipe out most of the expected effects of certain construction materials or techniques, create damaging disorder in the building, even jeopardise its continued existence.»*

Source : “La conception Bioclimatique” S.Courgey et JP Oliva

Poor workmanship or defects in materials’ implementation concern for the most part:

- water tightness;
- air tightness; and
- insulating materials (breaks in the insulation).

The general opinion is that losses due to poor workmanship in an otherwise energy-efficient building can lead to overconsumption of the order of 35%. It is thus indispensable to take measures to ensure the quality and carefulness of the work that is done, for example, by means of:

- better training about the materials used and their interactions for the various parties involved;
- regular monitoring of the quality of the work being done; and
- suitable timetables and salaries for careful workmanship (time and money mean quality).

However, the care that is taken in doing the work must not be limited to the placement of the various materials and components. The subsequent work of other tradespeople (plumbers, electricians, etc.) who come in close or distant contact with the materials making up the various walls of the dwelling is also concerned.

↑ Illustration 136 : Importance of a good implementation on building site



# Optimizing the external walls performances

---

Mentalities thus must change and each party involved in the project must take account of and respect the other parties' work and feel responsible for achieving the required quality standards.

This will be possible only through:

- better information and/or training for the building trades on how the components and materials work and interact with each other;
- more regular monitoring of the quality of the work that is done; and
- a fair wage in line with the quality of work and amount of time needed to achieve such quality.

### 3. THE OCCUPANT'S BEHAVIOUR AND BUILDING MAINTENANCE

When it comes to maintenance and the occupant's behaviour in a sustainably renovated dwelling, the key thing is to keep the renovated building and its walls in a state that will enable the building to conserve their initial performance values.

By maintenance we mean a series of daily, weekly, monthly, and even yearly actions to ensure the materials' optimal performances.

*Examples:*

- *cleaning the windows has an impact on light transmission and visual comfort.*
- *regular maintenance of the wood frames has an impact on their longevity.*
- *maintaining the furnace and sweeping the flues have a positive impact.*

It is thus vital that the occupants realise their responsibility when it comes to:

- the obligation to keep the dwelling and its components in good condition; and
- the obligation to replace installations or components, if need be, after a certain number of years.



↑ *Illustration 137 : Importance of the discussion between the different building actors*





## B.1. INCREASE THE THERMAL PERFORMANCES OF HOUSING

### Optimizing the orientation and the volume

N° of Sheet:  
**B11**  
Cross-references:  
**B10 to B19**  
Appendix:  
/



*“Giving priority to great compactness means, for a fixed inhabitable volume, limiting the building’s surface areas of heat loss and thus, its heating requirements, and the quantities of materials required to build its envelope. These two points have a direct influence on the building’s environmental impact and cost.”*

*Source: Guide pratique pour la construction et la rénovation durables de petits bâtiments, IBGE, Bruxelles, 2007*

Picture : Architecture et Climat

#### 1. PRINCIPLE

Depending on their orientation, the faces of a building or housing unit’s envelope are either heat-absorbing or heat-emitting surfaces (southern and northern walls, respectively), or alternately take up and give off heat (eastern and western walls and the roof).

When it comes to energy performance, the optimal form is one that meets the following three conditions:

- minimal heat loss;
- making maximal use of the sun’s rays in the winter; and
- providing maximal protection from the sun’s rays in the summer.

In renovation, one must optimise both the existing volume and the orientations of the façades in line with the interior layout and type of occupation even before working on the envelope’s performances (insulation, air tightness, and thermal bridges).

#### 2. OPTIMISING THE DWELLING’S VOLUME

Optimising the existing dwelling’s volume means working on its compactness, that is to say, minimising the surface areas of the envelope’s surfaces.

For an equivalent inhabited volume, the envelope with the smallest area of outer surfaces will lose the least heat.

In a renovation, the existing compactness of a building can be improved by:

- increasing the building’s volume by adding a storey;
- reducing overhangs and recesses in the volume; and
- making maximal use of party walls.

However, optimising a building’s compactness must be weighted by the need to have a sufficiently large area with a southern exposure to absorb heat from the sun’s rays<sup>1</sup>.

↓ *Illustration 138 : Rawhouses = reducing of energy, materials and space demand*



*For a wall with a given composition, varying its compactness will change the volume’s energy requirements considerably.*

*Compactness pleads in favour of party walls and greater housing density, which helps to reduce land occupation and car use and is conducive to more social ties and urban activities.*

*What is more, a building’s compactness is also justified from an economic standpoint, for the smaller amounts of materials used and simple shape will lead to lower construction (or renovation) and maintenance costs.*

1 See remark about orientation for northern countries

## Optimizing the orientation and the volume

### 3. OPTIMISING EXPOSURE TO SUNSHINE

In a renovation, a building's existing orientation can be improved by the following:

#### 3.1. A change in the envelope

Changing the glazed areas of the envelope lets you optimise the effects of the dwelling's orientation (enhancing the winter and summer heat conditions) by working on the following:

**- the surface area of glazing in line with the orientation**

The surface areas proposed below make it possible to exploit the sun's contributions maximally whilst limiting heat loss and the risks of overheating:

**- the window's height and shape**

For the same surface area, the windows' lintels must be placed as high as possible; the following "depth of room/lintel height" ratio is recommended for the mid-european countries:

bedrooms	< 2
livingroom	< 2.2
kitchen	< 2

This type of change is not always compatible with an existing urban dwelling, where the orientation is set by the layout of streets and blocks.

#### 3.2. Organisation of indoor space

Occupancy of the various living spaces of a dwelling varies with the season and day. Consequently, the designer must take care to arrange them according to the incident light, needs for warmth and/or coolness, and need for daylight as a light source:

Exposure	Room
North	Placement of service areas (garage, cellar, closets and pantries, entrance, bathroom, etc.). These rooms serve as buffer zones.
South	Placement of living areas (living room, kitchen, office, etc.). These areas should benefit from the sun's rays (solar gain) in the wintertime and large influxes of daylight.
East and West	Placement of rooms requiring a temperate environment (bedrooms).

Thanks to this organisation or heat zoning of the interior the service areas can be used as buffer zones, with major thermal transition and protection roles.

Exposure	Recommended percentage of glazing in the surface area compared with the room's square footage
South	> 15% Solar protection is necessary when the percentage exceeds 18%.
West	between 10% and 18%
East	between 10% and 18%
North	between 10% and 18%

↑ Illustration 139 : The surfaces presented here are suggested for the mid-european countries



↑ Illustration 140 : New windows dimensions - Sterrenveld renovation - Brussel



## B.1. INCREASE THE THERMAL PERFORMANCES OF HOUSING

### Additional insulation in housing renovation

N° of Sheet:  
**B12**  
 Cross-references:  
**B10, B13, B14, B15**  
 Appendixes:  
 /



Insulation plays a primordial role in renovation because it makes it possible to achieve the performance target that one has set, i.e., “passive” or “low energy” renovation.

Insulating a dwelling undergoing renovation makes it possible

- to increase the occupants’ thermal comfort in summer and winter alike;
- to limit the heat losses from the dwelling’s top, bottom, and sides;
- to limit the energy requirements (heating or air conditioning); and
- to limit the toxic emissions linked to combustion (wood, gas, heating oil, coal, etc.).

#### 1. WHY INSULATE ?

Insulation keeps heat from escaping from inside in the winter time and prevents the outdoor heat from invading housing’s interiors in the summer time.

When the air of an uninsulated dwelling is heated, the walls warm up little. The calories that reach the walls by convection and radiation go through them by conduction and escape outside.

The insulating material’s role is to set up a barrier between the inside and outside surfaces by means of materials with the lowest possible thermal conductance.

##### 1.1. Heat losses in winter

Heat losses are the “paths” that heat takes to escape outside in winter:

##### - Surface losses

These are heat losses through the walls, be they opaque (walls, roofs, etc.) or glazed.

In housing with medium energy performances (average  $U=0.45$ ), the surface losses can account for up to 50 % of a dwelling’s total heat losses.

##### - Heat losses due to thermal bridges

Thermal bridges are defects in the insulation’s placement that allow calories to pass through, often at the junction of two walls or separate elements.

Depending on the construction technique and insulation system used, these losses range from 5 to 25% of a dwelling’s total heat losses.

##### - Heat losses due to renewal of the air

These are heat losses linked to the dwelling’s indoor ventilation system but also to unwanted and uncontrolled infiltrations of air (via the woodwork, chimney flues, etc.).

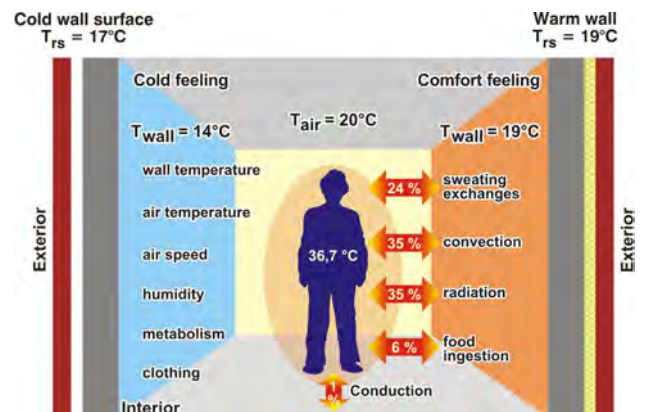

↑ Illustration 141: Explanation of thermal comfort



«The worst heat conductor is a “void” or empty space, which allows radiant exchanges only (1). However, “empty space” is actually filled with air, and the hot surface of the air wave exchanges its calories with the cold surface [of the wall] by convection (2). If the air is to conserve its insulating properties, it must be motionless, which is achieved by enclosing it in the smallest possible alveoli (3)»

Source : Isolation écologique, JP Oliva,

# Additional insulation in housing renovation

N° of Sheet:  
**B12**  
 Cross-references:  
**B10, B13, B14, B15**  
 Appendixes:  
 /

Insulating a dwelling in renovation thus means:

- limiting the surface heat losses;
- limiting the heat losses via thermal bridges (see information sheet B14); and
- limiting the heat losses due to the air's renewal (see information sheets A21 and B13).

## 2. A FEW DEFINITIONS

### 2.1. Thermal conductivity: coefficient $\lambda$

The thermal conductivity,  $\lambda$ , of a material is the heat flow that goes through 1 m<sup>2</sup> of a 1 metre thick wall when the temperature difference between the two surfaces of this wall is 1°C. It is measured by the coefficient  $\lambda$ . The larger the value of  $\lambda$ , the more the material conducts and transmits heat; the smaller the value of  $\lambda$ , the more insulating the material is.

Thermal conductivity is expressed in W/m.K or W/m.°C in the metric system.

### 2.2. Thermal resistance: coefficient R

The heat flow that goes through an element of the envelope or wall depends on the latter's thickness and thermal conductivity  $\lambda$ . Thermal resistance, R, is the ratio of the material's thickness over its thermal conductivity  $\lambda$  ( $R = e/\lambda$ ). The greater the thermal resistance, R, the more insulating the material is.

As a rule, a wall is composed of several materials with different thicknesses and thermal conductivities. In this case, one must sum the R values of each layer.

Thermal resistance, R, is expressed in m<sup>2</sup>K/W.

### 2.3. Surface transmission: coefficient U

To characterise an element of the envelope or wall's performance, one generally uses the coefficient U, which is the coefficient of surface transmission. This coefficient is the reciprocal of thermal resistance ( $U= 1/R$ ) and is expressed in W/m<sup>2</sup>K.

## 3. INSULATION - ELEMENTS TO TAKE INTO CONSIDERATION

In renovation it is always interesting to conduct an energy audit so as to reveal the thermal performances of the dwelling's various walls, floors, and roofs and the relevance of improving them. Such a study makes it possible to determine which investments are the most worthwhile to make. What is more, when one wishes to improve the insulation of the dwelling's envelope, other points that are intrinsically linked to insulation must also be taken into consideration. These are:

#### - Thermal bridges

Adding insulation in an existing building can create or worsen thermal bridges. Those thermal bridges can concentrate condensation and humidity and lead to the proliferation of fungi and deterioration of the quality of the air. It is thus necessary to be particularly attentive to this aspect.

#### - Air quality

The addition of insulation in an existing building must be accompanied by a hygienic ventilation system to avoid problems of condensation and to ensure good indoor air quality. This hygienic ventilation is all the more important with increasingly high performance glazing.

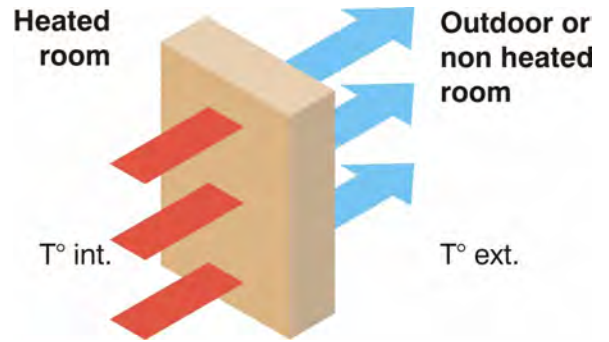

↑ Illustration 142 : Thermal conductivity

### Insulation coefficient - Mid-Europe

Standard «low energy consumption»	
U max. external walls	0.3 W/m <sup>2</sup> K
U max. roof	0.2 W/m <sup>2</sup> K
U max. frame/glazing	1.8 W/m <sup>2</sup> K
U max. slab	0.3 W/m <sup>2</sup> K
Passive standard	
U max. external walls	0.15 W/m <sup>2</sup> K
U max. roof	0.15 W/m <sup>2</sup> K
U max. frame/glazing	0.8 W/m <sup>2</sup> K
U max. slab	0.15 W/m <sup>2</sup> K

*In renovation, when the designer wish to improve the housing insulation, he'll try to tend to the passive standard.*

### Insulation coefficient - Northern Europe

Standard «low energy consumption»	
U max. external walls	xx W/m <sup>2</sup> K
U max. roof	xx W/m <sup>2</sup> K
U max. frame/glazing	xx W/m <sup>2</sup> K
U max. slab	xx W/m <sup>2</sup> K
Passive standard	
U max. external walls	xx W/m <sup>2</sup> K
U max. roof	xx W/m <sup>2</sup> K
U max. frame/glazing	xx W/m <sup>2</sup> K
U max. slab	xx W/m <sup>2</sup> K

↓ Illustration 143 : Thermal bridges during the heating season

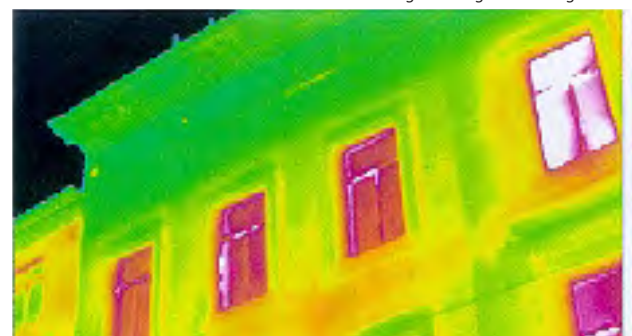

# Additional insulation in housing renovation



↑ Illustration 144 : Insulation of the envelope



↓ Illustration 145: External insulation of an existing housing - Belgium

### - Water balance of the walls

The quality of a wall will depend in particular on its behaviour in connection with the migration of water vapour. Given that the addition of insulation modifies this behaviour, it is imperative to take this aspect into account.

## 4. HOW TO INSULATE IN RENOVATION

In renovation, insulating a dwelling can be envisioned in two different ways:

### - Insulating the building's envelope

This is the most complete and most logical solution in terms of energy performance. The insulation can be placed on the inside or the outside.

### - Insulating certain rooms in the building

It is sometimes costly to insulate the entire outer envelope of a dwelling. What is more, the various rooms making up the dwelling are occupied intermittently and have different heat needs. In the case of renovation one may thus consider insulating only the most important living areas (living room, kitchen, and bedrooms), that is to say, the rooms that are used most often and where the family members spend most of their time. According to this principle, these rooms will become “retreat zones” in the event of periods of cold or freezing temperatures.

### 4.1. Which sides of the dwelling must be insulated?

When insulating a dwelling that is being renovated, one must take care to insulate

- the outer surfaces of the dwelling (ground, walls, windows, and roofs) and
- the barriers between the heated volume and unheated volumes (walls, doors, etc.).

### 4.2. Various modes of insulation

There are four different ways to insulate a dwelling that is being renovated. The choice of one insulating approach over another depends upon the thermal targets that have been set but also upon aesthetic criteria, economic criteria, and ease of application. The advantages and disadvantages of each of these four methods are summarised in the table below:

### 4.3. Insulating the envelope on the outside

In renovation, if one chooses to insulate the envelope on the outside, the insulation is applied to the façade:

- Case 1: Solid brick wall (diagram)
- Case 2: Double wall with brick facing or cladding (diagram)

The insulation must be protected by a new facing, i.e., a synthetic or mineral coating (the cheapest solution), wooden cladding, or brick facing (more expensive solutions). This also guarantees the continuity of the insulation and reduces the number of thermal bridges greatly. However, this is not easily done in urban settings, in the cases of dwellings that give onto the street or dwellings in “listed buildings”, where the appearance of the façade that is seen from the street may not be altered.

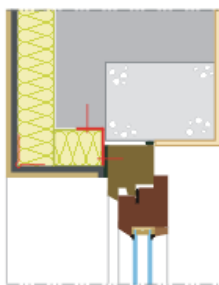

↑ Illustration 146 : Detail of wall insulation

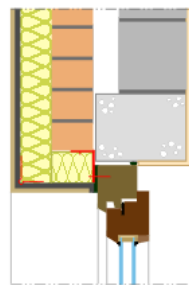

↑ Illustration 147 : Detail of wall insulation



↑ Illustration 148 : Detail of wall insulation



↑ Illustration 149 : Detail of wall insulation

## Additional insulation in housing renovation

### 4.4. Insulating the envelope on the inside

When it is not possible to insulate on the outside, one should envision insulating the dwelling on the inside. This is also the only technique that may be applied when the façade must be kept as is.

Before beginning insulation work on the inside, one must be absolutely certain that:

- the outer protective wall is in good shape and can withstand bad weather (including freezing temperatures), since it will no longer be influenced by the indoor climate;
- the interior bearing wall is sound, dry, and protected from infiltrations;
- the internal placement of the window frames with regard to the bays, the ground with regard to the wall, etc., is such that thermal bridges can be controlled;
- the internal climate is normal when it comes to temperature and humidity; and
- the walls and floors have sufficient inertia.

The insulating system will be chosen according to the amount of space available in the rooms and above all the state of the walls' inner surfaces:

- when the inside surface of the wall is sufficiently smooth, the insulation may be glued on to it directly;
- otherwise, the insulation must be placed on a trellis of slats, between the slats (but risk of thermal bridges), or even behind a masonry partition (creation of internal inertia).

#### - Condensation risk

In placing an insulating material on the inner face of a wall one creates a barrier between this wall and the indoor climate.

The effect of this is to prevent the wall from warming up. As a result, the structure's dew point (which is the temperature at which condensation forms) is shifted towards the inside.

Steps must thus be taken to avoid allowing the water vapour to come in contact with the wall and condense between the wall and the insulation. To do this, one will place

- the least permeable materials on the warm side of the insulation and
- a vapour barrier between the insulation and the interior finishing.

However, the risk of condensation can be reduced by an effective hygienic ventilation and the use of certain insulating materials such as cellulose, wood wool, etc., that can absorb large amounts of moisture without losing their thermal performance and release the moisture to the atmosphere if necessary. This particular behaviour enables them to regulate the humidity in the room.

#### - Risk of discontinuity in the insulation

Generally speaking, the insulation and vapour barrier (if necessary) must be placed without a seam so as to avoid the risk of condensation, especially at the junctures with the walls, between walls and ceilings, between walls and bays, and so on. It is not always easy to achieve such continuity, and all of the places of junction must be studied in depth.

Below we give some examples of insulation placement:

- Outer wall - wooden floor junction
- Outer wall - concrete slab junction
- Outer wall - inner wall (partition) junction
- Outer wall - roof junction
- Outer wall - foundation slab junction



↑ Illustration 150: Insulation by inside (between beam and wall)



↑ Illustration 151 : Insulation by inside

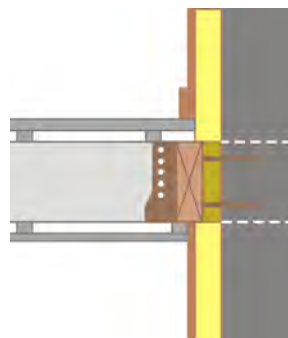

↑ Illustration 152: Insulation by inside (between beam and wall)



↑ Illustration 153 : Insulation by inside (floor and wall)

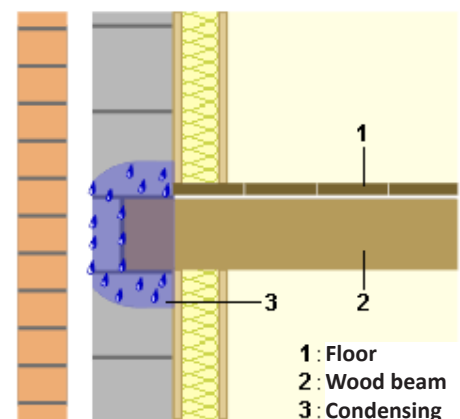

↑ Illustration 154 : Condensing risk

## Additional insulation in housing renovation

### 4.5. Mixed insulation of the envelope

In urban settings, renovating a dwelling with a party wall and façade on the street often requires using the two preceding techniques, to wit,

- the front façade is insulated on the inside and
- the back façade is insulated on the outside.

The combination of these two techniques must be applied whilst taking as much care as possible to avoid thermal bridges. That means that the two layers of insulation must overlap at the places where a wall that is insulated on the outside meets a wall that is insulated on the inside.

### 4.6. Insulating the envelope by filling the cavity between two wythes

#### - Type of hollow wall (cavity wall)

The insulating technique may or may not be envisioned, depending on whether the hollow wall is recent or not:

- In the cavities of old walls, the inner and outer wythes are linked by bricks that form so many thermal bridges. It is useless to place insulation in the cavity in such cases. Rather, one should consider insulating on the outside or on the inside.
- In the cavities of more recent walls, the sizes of the thermal bridges must be inspected using an endoscope and, depending on the findings, the decision to insulate or not to insulate the cavity is taken.

#### - Verifications and preliminary measurements

Before starting the work, one must do a preliminary examination of the cavity to check the condition and quality of the hollow wall. This examination is easy to do without taking the wall apart thanks to a specialised instrument such as an endoscope.

One thus checks:

- the possibility of treating the thermal bridges perpendicular to the lintels, returns of the bays, walls, feet of the walls, cornices, and so on.
- for the absence of debris, waste, and other materials in the cavity.
- for the correct positioning of the hooks between the two wythes of the wall.
- for the existence of correctly placed waterproofing membranes.
- for the presence of openings to drain the cavity placed just above the waterproofing membranes.

One must also check that:

- the outer facing is not covered over by an impermeable layer that prevents the water vapour's diffusion and drying of the facing.
- the facing bricks are designed to withstand the greater thermal constraints (as they will be less influenced by the indoor temperature, thereby increasing the risk of problems in the event of freezing temperatures).

#### - Insulating techniques and materials

There are ways to fill the cavity and various insulating materials that can be used for this purpose. As a rule, one chooses the system that consists in blowing a bulk insulating material into the space. The foam injection technique is not commonly used today. It requires accurate monitoring of the filling and the foam's expansion to avoid exerting too much pressure and pushing the facing out of shape.

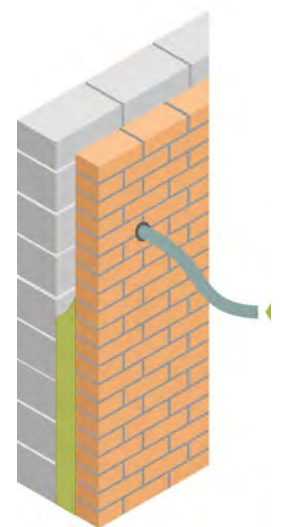

↑ Illustration 155 : Insulation of the cavity



↑ Illustration 156 : Vermiculite



↑ Illustration 157 : Endoscope

## Additional insulation in housing renovation

The insulating material

- must be neither capillary nor hydrophilic (it must not absorb or hold water),
- must be sufficiently permeable to water vapour, and
- must have enough consistency to keep it from slumping.

### 4.7. Advantages and disadvantages of the insulation modes

Insulation mode	Advantages	Desadvantages
<b>Insulation by outside</b>	Eliminating risks of local thermal bridges Protecting the wall from freezing and fissuring Protecting the wall from penetration by driving rain Improving the external appearance in the case of a degraded external surfacing Conserving thermal inertia Conserving inside volumes and finishing	Changing the outside appearance (town planning permit application – difficulties with listed buildings and heritage sites) Costly solution, because it involves a new facing Possible encroachment on public ground
<b>Insulation by inside</b>	The external appearance is conserved (no town planning permit application) The cost is generally lower than for insulating on the outside	Thermal bridges sometimes not eliminated Possible degradation of the outer wall due to its cooling and increased dampness Risk of fissuring due to the temperature variations in the outer wall New interior finishes and smaller interior volumes (according to the insulation's thickness) Loss of thermal inertia Continuity of the vapour barrier difficult to achieve Modification of water network – placing the pipes so that they are protected from freezing
<b>Insulation in the hollow (double wall)</b>	Conserving thermal inertia Simple and less costly technique than insulating from the outside The external appearance is conserved (no town planning permit application)	Risk of thermal bridges at the breaks in the cavity Cooling of the facing wall Prior examination of the cavity is indispensable Ability to dry out the external surface of the wall is lessened
<b>Insulation with a mixing of the two first systems (inside and outside)</b>	Idem outside insulation and inside insulation	Idem outside insulation and inside insulation



## B.1. INCREASE THE THERMAL PERFORMANCES OF HOUSING

### Additional insulation in housing renovation

N° of Sheet:  
**B12**  
 Cross-references:  
**B10, B13, B14, B15**  
 Appendixes:  
 /

#### 5. INSULATING MATERIALS

The type of insulating material used in the renovation project will have an impact on not only the quality of the building's insulation (thermal comfort and energy consumption), but also on the environment (emission of pollutants, use of harmful products, etc.) and human health (during its application).

It is thus vital to find the best compromise amongst the three givens (energy performance, respect for the environment, and human health) in an overall concept of sustainable development.

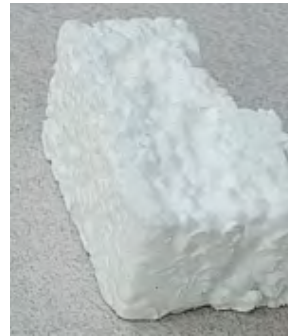

↑ Illustrations 158 and 159: Insulation coming from petrochemical industry : EPS and PUR

Materials	Density $\rho$ (kg/m <sup>3</sup> )	Thermal conductivity $\lambda$ (W/mK)	Origin of raw material	Embodied Energy (production) (MJ/kg)	Global Warming Potential (production) (kgCO <sub>2</sub> eq / kg)	Acidification Potential (production) (kgSO <sub>2</sub> eq / kg)	Life span (years)
Extruded polystyrene	15 - 20	0.028 à 0.038	world	93.4	3.73	0.02515	30
Expanded polystyrene	15 - 30	0.031 à 0.045	world	106	4.01	0.02216	30
Polyurethan (board)	40	0.023 à 0.029	world	103	4.21	0.0668	30
Glasswool	40 - 110	0.031 to 0.044	UE	48.66	1.49	0.00723	30
Mineral wool	60 - 130	0.031 to 0.044	UE	22.6	1.46	0.00852	30
Cellular glass (board)	100 - 150	0.038 to 0.050	UE	26.3	1.26	0.0033	> 50
Expanded perlite (board)	170	0.052 to 0.055	UE	16.8	0.99	0.00236	?
Expanded clay	400	0.15	UE	4.4	0.33	0.00215	> 50
Wood fibers (mattress)	75	0.038 to 0.04	UE	25.62	-1.33	0.00206	30
Wood fibers hard panel	140 - 240	0.04 to 0.047	UE	41	-0.09	0.00954	30
Cellulose (flock)	35	0.04	UE	9.72	0.27	0.00264	30
Cellulose (board)	50 - 150	0.035 to 0.055	UE	21.2	1.61	0.0123	30
Cork (flock)	100	0.04 à 0.045	UE	52.3	-0.71	0.0029	50
Cork (board)	80 - 120	0.032 à 0.045	UE	52.3	-0.71	0.0029	50
Hemp fibers (mattress)	30 - 35	0.039 à 0.08	UE	41.8	0.21	0.01312	30
Flax fibers (mattress)	30 - 35		UE	50.5	0.22	0.00764	30
Coconut fibers (mattress)	50	0.056	world	54.1	0.56	0.0363	30
Sheep wool	10 - 30	0.035 à 0.045	UE/world	27.6	-0.24	0.0034	30

Sources: Ecobilan KBOB 2009/1 ([www.ecobau.ch](http://www.ecobau.ch)) - Datas base ECOSOFT ([www.ibo.at](http://www.ibo.at)) - [www.catalogueconstruction.ch](http://www.catalogueconstruction.ch)

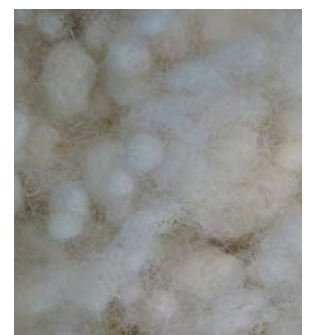

↑ Illustrations 160, 161, 162 and 163: Natural fibers insulation : coconut fibers, wood fibers, cork and sheep wool





## B.1. INCREASE THE THERMAL PERFORMANCES OF HOUSING

### Improving the air tightness

N° of Sheet:  
**B13**  
Cross-references:  
**B10, B12, B18, B19**  
Appendix:  
/



Picture: T.Demeester

It is necessary to ensure good air tightness of a building's envelope. Indeed, influxes of air into buildings:

- create uncomfortable draughts,
- reduce the quality of the envelope's acoustic insulation,
- generate additional energy use that must not be discounted, and
- can cause condensation inside the wythes, leading to problems of dampness and/or moulding.

Making a building airtight does not mean, however, cutting off the intakes of fresh air. On the contrary, it is important to work on both the envelope's air tightness and an effective ventilation system

#### 1. WEAK POINTS OF THE ENVELOPE

From the standpoint of the comfort and energy balance of housing, unwanted infiltrations of air into a building can be considered a problem. Such unwanted currents of air can go both from the outside (or from unheated rooms) into the building and from inside towards the outside. The former generate energy losses and discomfort for the inhabitant, but the latter can in addition generate a risk of condensation in the wythes (example: piercing the inner coating of a wall inadvertently to house a power outlet) when the moist, warm air meets a colder surface. These infiltrations of air are due primarily to weak points in the envelope that one must strive to reduce or eliminate in the course of the renovation.

The main weak points of the envelope are as follows:

##### - On the woodwork that closes openings

- the seals between the leaves and (window and door) frames
- the casings of rolling slat blinds
- the flues of open fireplaces without flue covers
- trapdoors in the eaves

##### - On the external envelope

- the links between walls and woodwork
- the links between walls and roofs
- the cable sheaths, various connections, etc.

#### 2. QUALITY OF AIR TIGHTNESS

The quality of air tightness depends upon various parameters, such as

- the quality of placement of the vapour barrier and vapour-resistant layers;
- the nature and quality of the surfacings; and
- the quality of the external woodwork and the quality of the seals between the wall and woodwork

##### 2.1. Renovation worksite

The quality of air tightness depends to a great extent on the

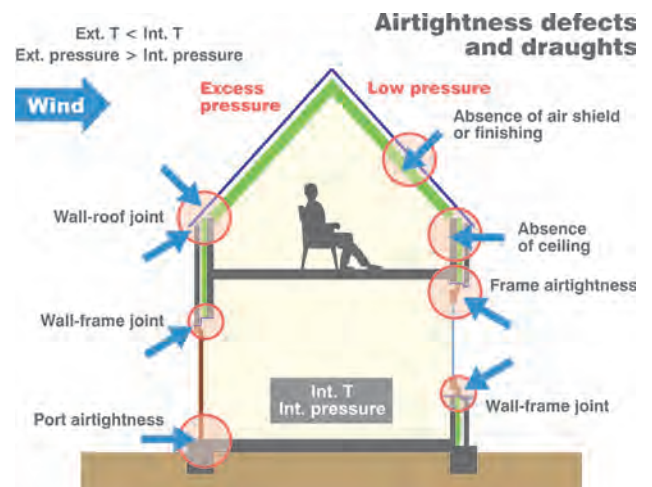

↑ Illustration 164 : Failings of air tightness in the building envelope.

## B.1. INCREASE THE THERMAL PERFORMANCES OF HOUSING

### Improving the air tightness

N° of Sheet:  
**B13**  
 Cross-references:  
**B10, B12, B18, B19**  
 Appendix:  
 /

care taken in placing the materials. It is thus indispensable:

- to talk with the renovation firm and workers so as to get top-quality placement of the materials; and
- to monitor the worksite very strictly, especially when it comes time to place the vapour barrier and/or vapour-resistant layer.

At the end of the work, a pressurisation trial combined with infrared photography (in winter) may be performed to check for possible leaks and correct them. This test is compulsory to obtain the “passive house” label.

#### 2.2. National regulation of air tightness

The levels of air tightness is regulated nationally.

For example:

Belgium	<b>n50 &lt; 3/h</b> : if mechanical ventilation <b>n50 &lt; 1/h</b> : if mechanical ventilation with heat recovery
Germany	
Norway	minimum <b>n50 &lt; 4/h</b> : if mechanical ventilation
Sweden	minimum <b>n50 &lt; 3/h</b> : if mechanical ventilation
Switzerland	<b>n50 = 2/h</b> : if natural ventilation <b>n50 = 1/h</b> : if mechanical ventilation with heat recovery

#### 2.3. Blower door test

The quality of a building’s air tightness can be analysed by the “blower door” technique. This technique consists in pressurising or creating negative pressure in a room by means of a fan and then detecting the places where air passes through the envelope. These infiltrations can be visualised by infra-red heat photography, an anemometer (to detect air movements); or by artificial smoke.

The degree of air tightness of the envelope is expressed as the amount of air (number of changes of air) that must be blown in to maintain a pressure difference of 50 Pa in the building. This is the “n50” value.

In renovation, one should try to reach the air tightness required by the passive standard, that is, an n50 value that is less than 0.6 m<sup>3</sup>/hm<sup>3</sup> in the metric system. However, in the case of a low-energy design, if the house is equipped with a double-flow ventilation system with recovery, an n50 value of between 1 and 3 m<sup>3</sup>/hm<sup>3</sup> is accepted.

### 3. IMPROVING AIR TIGHTNESS

When renovating dwellings, the designer will try to eliminate or reduce radically unwanted air infiltrations in order to improve the occupants’ comfort and save energy. To do this, he/she will take the following measures:

#### 3.1. Windows and openings

##### - Front door

The front door is a weak point when it comes to a dwelling’s air tightness. In renovation, the designer will take care to

- avoid placing the door on the façade that is exposed to the prevailing winds;
- provide an air-lock; and
- install a system that limits the influxes of air: airtight baseboards, etc.

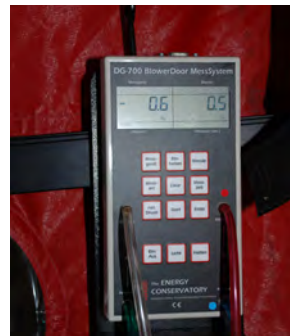
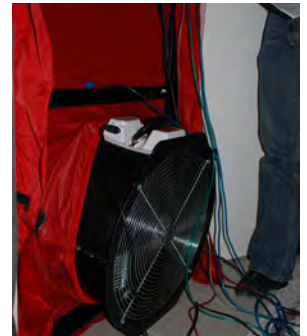

- ↖ Illustration 165:  
Air extracted - vacuum
- ↑ Illustration 166:  
Air insufflated - high pressure
- ← Illustration 167: Anemometer

↓ Illustrations 168 and 169 : Openings details to limit the air infiltrations



↓ Illustration 170: Air and water tightness of a frame

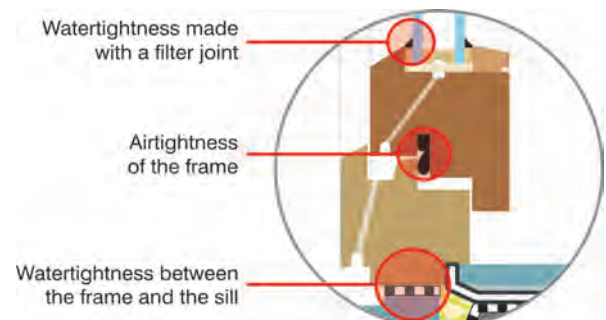



↑ Illustration 171 : Connections between external wall and frame in old



↑ Illustration 172: External coating on masonry

**- Window and door frames**

When the window and door frames have poor insulating and air tightness performance, they must be replaced by frames with profiles that have at least a double barrier for air and water tightness, i.e., a water barrier on the outside and an air barrier on the inside, located in the same plane around the frame's entire perimeter and separate by a drained decompression chamber.

**- Outer wall/frame junctions**

In the case of old frames, the outer wall and frame are usually joined by means of a cement mortar, which often cracks with time and is thus insufficiently airtight. This joint can be redone. This is done in four steps, as follows:

- you remove the existing caulking (mortar or putty), including the back-up material, if there is one.
- you clean and strip the lips of the joint of all grease.
- you apply back-up material, for example by placing a pre-shaped packing with closed cells in the space.

In the case of a solid wall, it is advisable to create a decompression chamber between the external retightening with the building's carcass and the interior retightening:

- you apply an elastic putty on top of this back-up material, taking care to ensure good contact between the lips of the joint.

**3.2. Exterior walls**

**- Placement of a vapour barrier**

When one also wants to improve the dwelling's insulation, a vapour barrier or a layer that slows down the vapour's passage that provides air tightness should also be placed.

**- Exterior/interior finish**

Any cracks or fissures in the surfaces of the wythes that encase the protected volume must be plugged.

The porous materials that are used in building (bricks, concrete blocks, mineral wools, etc.) are permeable to air if they are not coated. What is more, the joints in the masonry are not always correctly done. The vertical joints can be partially filled, for example, but this flaw can be hidden by the tuck-pointing. This will increase the permeability of the entire masonry even more. To improve the envelope's air tightness, these materials must be protected with a thin airtight layer, e.g., a coating (on the outside or inside) or correctly tuck-pointed coated plaster-board. A thick layer of paint that forms a film may also be suitable.

**3.3. Roof**

In renovation, the designer will study the various connections in and with frame roofs in detail (see diagram).

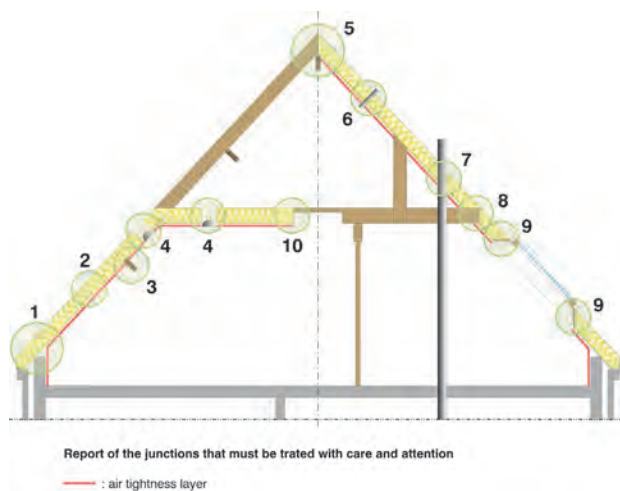

↑ Illustration 173: Junctions that must be treated with care and attention





## B.1. INCREASE THE THERMAL PERFORMANCES OF HOUSING

### Reducing the thermal bridges

N° of Sheet:

**B14**

Cross-references:

**B10, B12, B19**

Appendix:

/

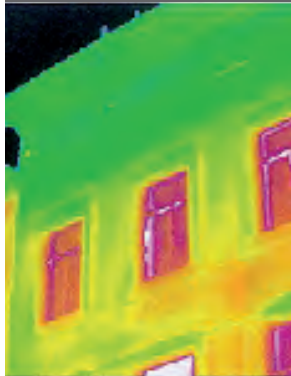

*“Thermal bridges are not only sources of major heat loss due to the leakage of calories. They are also sources of excessive energy consumption and the seats of condensation that can lead to indoor air pollution and premature deterioration of the building”*

Source: La conception bioclimatique, JP Oliva

Picture: [www.energieplus-le-site.be](http://www.energieplus-le-site.be)

#### 1. DEFINITION

Thermal bridges are flaws in the design and/or construction of the insulating envelope that are characterised by local breaks in the envelope’s insulating ability that can lead to major heat loss.

##### 1.1. Origins of thermal bridges

Thermal bridges occur primarily at junctures and seams (window, balcony, lintel, façade/roof, etc.).

They can be caused by:

###### - A construction constraint

The principle of the insulating layer’s continuity was not or could not be respected in some cases in certain places.

These are, for example, the anchoring or bearing points between elements located on either side of the wythe’s insulating layer. Given the absence of insulation in those places, the heat flow is measurably denser in such parts of the wythe.

###### - A geometrical constraint

This type of thermal bridge is due to the shape of the building’s envelope in a given spot, i.e., the area of its outer face is much larger than the area of its inner face.

The heated surface (on the inside) is thus smaller than the cooling surface (exterior face).

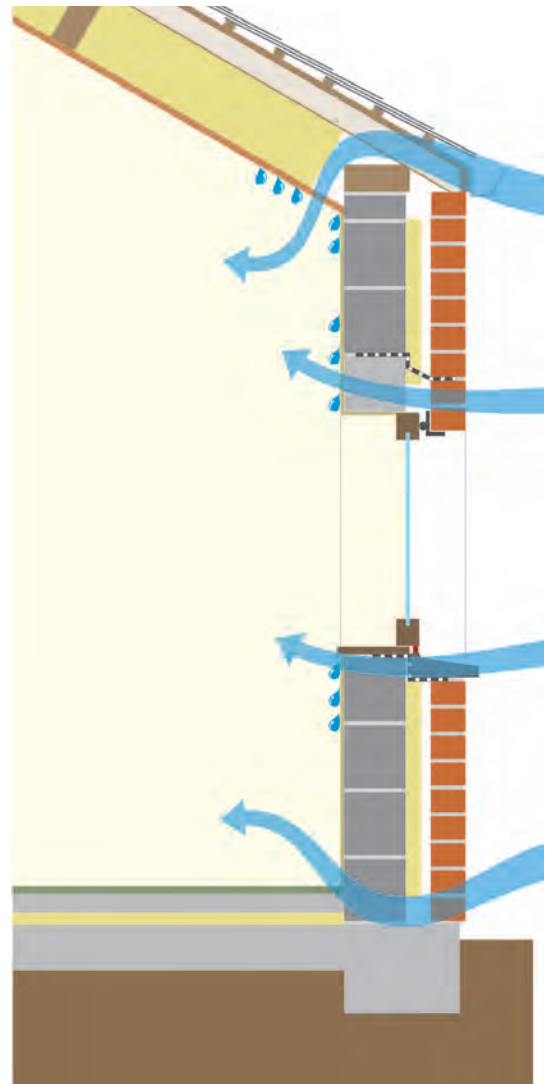

↑ Illustration 174 : Zones with thermal bridges

## B.1. INCREASE THE THERMAL PERFORMANCES OF HOUSING

### Reducing the thermal bridges

N° of Sheet:  
**B14**  
Cross-references:  
**B10, B12, B19**  
Appendix:  
/

#### 1.2. Consequences linked to the presence of thermal bridges

Thermal bridges can have many unpleasant consequences: localised condensation that can lead to the growth of fungi, discomfort, health problems, excessive energy consumption, and so on.

##### - Impact on energy consumption

For a building with average insulation, the heat loss that can be attributed to thermal bridges can account for 10 % of its total heat loss. The more the building is insulated, the greater the relative importance of the heat losses induced by insulation flows (up to 25% of the total heat loss).

##### - Impact on the occupants' health

By creating cold points, thermal bridges are propitious areas for condensation of indoor humidity. Moulds can develop in these humid areas. Besides being unpleasant to look at, these moulds are proven health risks (respiratory problems, asthma, etc.) and carry a risk of early deterioration of the building materials and products.

##### - Impact on the occupants' comfort

Surfaces that are located near thermal bridges are characterised by surface temperatures that are lower than the average temperature of the wythes. This can create the feeling of a cold wall, feeling of draught and discomfort for the occupant.

##### - Impact on the materials' lifespans

When the amounts of condensed water are high and cannot be eliminated daily, they soak through the surfacings and wallpaper and lead to their deterioration. When condensation occurs in wood, the wood will rot. The rate at which it rots will depend on the species of wood and its protective treatment. If the degree of condensation is high, the wythe may become very damp through and through. The bearing structure of the building itself may deteriorate under the effect of the constant damp and, depending upon the circumstances, freezing of the materials.

## 2. LIMITING THERMAL BRIDGES IN RENOVATIONS

It is not easy to solve all of the thermal bridge problems that exist when renovating a structure, especially when the external and/or interior appearance of the building must be preserved. The designer will have to take the following approach:

- detect the various thermal bridges, or in any event the most problematic ones and then
- study each thermal bridge and determine the best way to solve the problem.

#### 2.1. Detecting a thermal bridge

The presence of a thermal bridge in an existing building can be identified by visual signs such as damp patches and moulds. However, visual indicators are not always reliable. It is thus highly advisable – especially if one wants to achieve the passive standard – to carry out a special study that includes an exhaustive search for the existing thermal bridges using the appropriate tools, such as infrared thermography (infrared photography of the building during the heating period), surface thermometers, and so on.

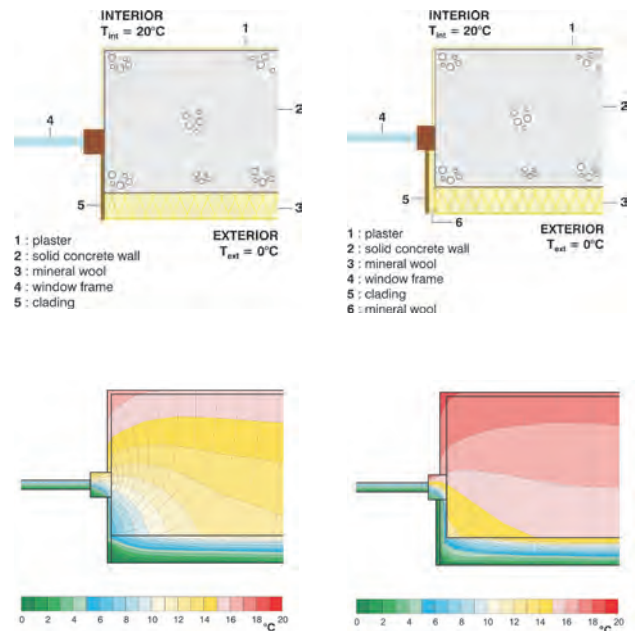

↑ Illustrations 175 and 176 : Impact of thermal bridges on thermal comfort

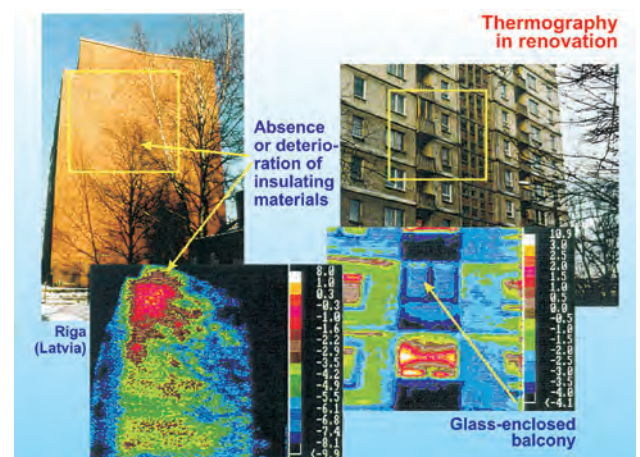

↑ Illustration 177: Infra-red photography in period of heating



Reducing the thermal bridges

N° of Sheet:  
**B14**  
 Cross-references:  
**B10, B12, B19**  
 Appendix:  
 /



Resolving or eliminating all of the thermal bridges in an existing dwelling may prove extremely arduous for the designer or architect. That is why certain thermal bridges are tolerated, if they are small and resolving them would be particularly complex and/or expensive.

**2.2. Eliminating a thermal bridge**

This information sheet proposes a series of standard details to help the designer to resolve the various thermal bridges that he or she may encounter (see Point 3).

**3. RESOLVING THERMAL BRIDGES**

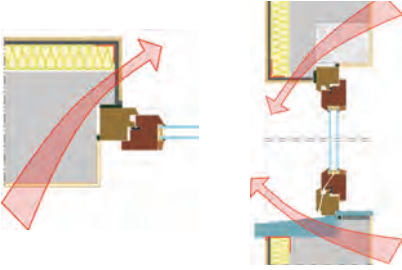
**3.1. Solid wall insulated on the outside**

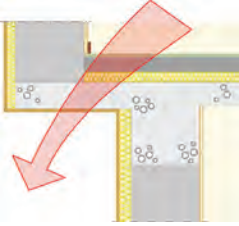
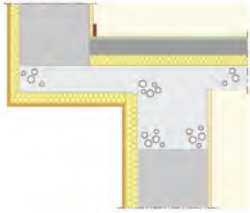
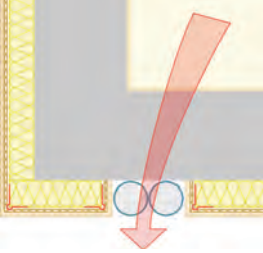
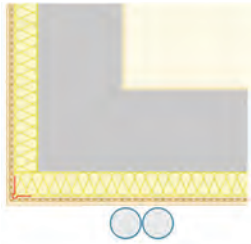
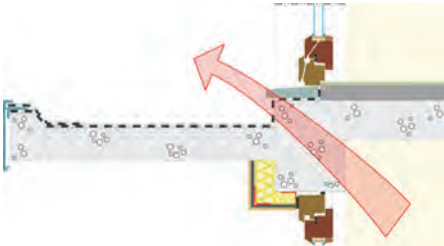
	Problems	Possible solutions
Window frames		
Overhangs		
Gutter		
Terace		<p>It doesn't exist simple solution for this type of construction detail.</p> <p><i>Two typical solutions are:</i></p> <ul style="list-style-type: none"> <li>- vacuum insulation on top (if heated space underneath)</li> <li>- cut balcony and rebuild with a new independent construction, thermally separated</li> </ul>

Reducing the thermal bridges

N° of Sheet:  
**B14**  
 Cross-references:  
**B10, B12, B19**  
 Appendix:  
 /

3.2. Solid wall insulated on the inside

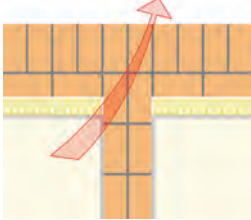
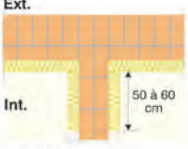
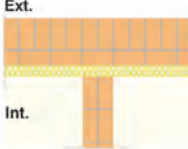
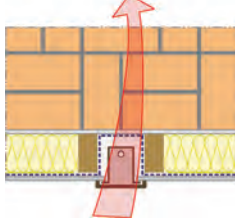
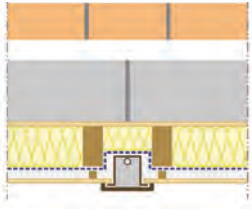
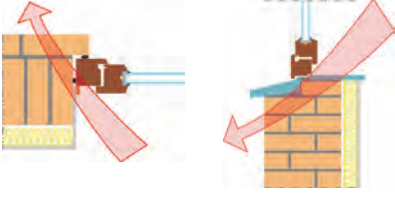
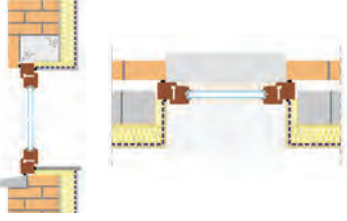
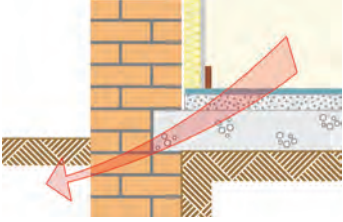
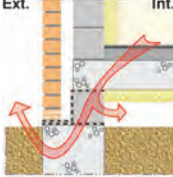
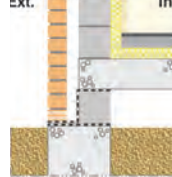
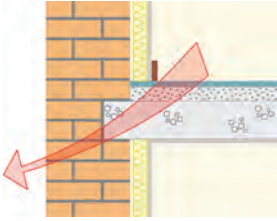
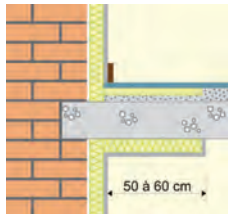
	Problems	Possible solutions
Canted wall		<div style="display: flex; justify-content: space-around;"> <div style="text-align: center;">  <p>Ext. Int. Solution 1</p> </div> <div style="text-align: center;">  <p>Ext. Int. Solution 2</p> </div> </div>
Receptacles Pipes		
Frame Lintel Windowsill		
Groundslab		<div style="display: flex; justify-content: space-around;"> <div style="text-align: center;">  <p>Ext. Int. Ext. Int. Solution imparfaite</p> </div> <div style="text-align: center;">  <p>Ext. Int. Ext. Int. Solution complète</p> </div> </div>
Floorslab		



## B.1. INCREASE THE THERMAL PERFORMANCES OF HOUSING

### Thermal inertia in housing renovation

N° of Sheet:  
**B15**  
 Cross-references:  
**B10, B16, B17, B19**  
 Appendix:  
 /

The thermal inertia of a building or wall is its ability to store heat and then give it off after a certain time lag. Regardless of the season, high thermal inertia in a dwelling will be a source of comfort for its occupants, for by helping to attenuate the temperature fluctuations in the rooms it helps to avoid both overheating and temperature drops, as follows:

- when combined with effective solar protection and nocturnal ventilation, it helps to maintain a certain coolness inside the dwelling in summer;
- in winter it lets you store up free solar heat gains and limit heating needs in the evening.

#### 1. DEFINITION

The thermal inertia of a wall is determined by the thermal capacity of the materials of which it is made.

##### 1.1. Thermal capacity (S)

The thermal capacity of a material is its ability to store heat per unit of volume. It is defined by the amount of heat needed to raise the temperature of 1 m<sup>3</sup> of the material 1°C. The material's thermal capacity is the product of its specific heat times the material's density. It is expressed in kJ/m<sup>3</sup>.°C in the metric system. It depends on the following three parameters:

##### - the thermal conductivity of the material ( $\lambda$ )

The thermal conductivity of a material or  $\lambda$  is the "heat flow" that goes through 1 square metre of a 1 metre thick wall when the temperature difference between the two surfaces of the wall is 1°C.

Thermal conductivity is the reciprocal of insulating power.

##### - the specific heat of the material (c)

The specific heat capacity of matter or "specific heat" for short is expressed in J/kgK in the metric system.

The specific heat of a material is its ability to store heat per unit weight. It is defined by the amount of heat necessary to raise the temperature of one kilogram of the material 1°C.

##### - the density of the material

Density is expressed in kg/m<sup>3</sup> or t/m<sup>3</sup>.

Generally speaking, the heavier a material is, the higher its thermal capacity.

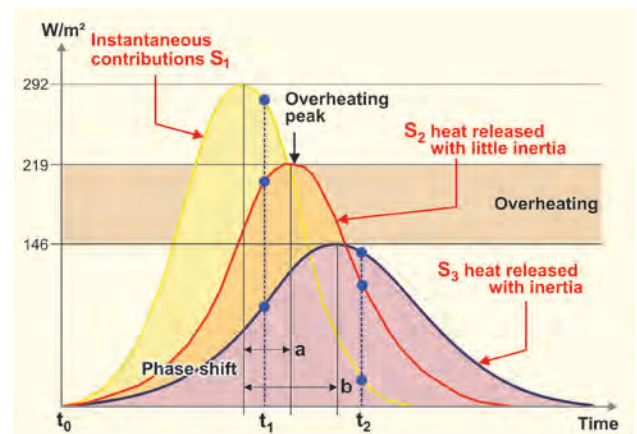

↑ Illustration 178 : Thermal inertia and overheating



↑ Illustration 179 : Solid wall



↑ Illustration 180 : Wood frame

**2. WHERE AND HOW DOES ONE PLACE INERTIA?**

Thermal inertia is one of the main tools of bioclimatic housing design. It makes it possible to regulate both the free solar heat gains and the heating system's contributions in winter.

**2.1. The roles of the various walls**

All of the walls of a room or premise do not play the same role in the premise's thermal conditions:

**- Thermal comfort – Winter and mid-season**

To benefit maximally from solar heat gains in the winter or between seasons, one basically works with the inertia of the foundation slab and, if necessary, with the inertia of the interior walls that get part of the sun's radiation (low radiation that penetrates deep into the dwelling).

**- Thermal comfort - Summer**

To limit the risks of overheating in the summer, one basically works with the inertia of the foundation slab, which, when subjected to the sun's direct radiation, should absorb this radiation and re-emit as little as possible of this heat into the dwelling's interior.

So-called "insulating" ground surfaces such as wall-to-wall carpeting, parquets, and, to a lesser extent, vinyl coatings and lino-leums should thus be avoided.

**- Intensive ventilation by night and thermal inertia**

When one works with intensive night ventilation, all of the dwelling's "walls" (including the foundation slab and interior walls) have a role to play as heat buffers.

**2.2. Choosing the materials**

The first centimetres of material in contact with the indoor air are the most important when it comes to inertia. Indeed, effective heat exchanges must be created with just these first centimetres.

The type of finishing used in renovating a building will have an impact not only on the thermal quality of the inertia (thermal comfort of the dwelling) but also on the environment (emission of pollutants, use of harmful products, etc.) and human health (that of the workers during the installation work and that of the occupants thereafter). In a comprehensive concept of sustainable renovation it is thus vital to find the best compromise amongst these three givens.

Generally speaking, when one wants to work with inertia, one should avoid insulating floor coverings such as rugs, wall-to-wall carpeting, and parquets.

**Wood frame constructions and thermal inertia**

*There is a tendency for designers involved in renovations that include additions to the existing volumes to use light building methods (wood frames). This tendency in favour of light structures is found in both renovation and new building projects. It should be encouraged when it is accompanied by thick insulating layers, but must not be to the detriment of summer comfort. The ideal approach would be to build façades with wood frames so as to provide great insulation and a solid inner structure with high inertia.*

↓ Illustration 181: Coverings with high inertia : tiling and stones



© Carrières de la Pierre Bleue-Belge

↓ Illustrations 182 and 183 : Covering with low inertia : carpet and wood

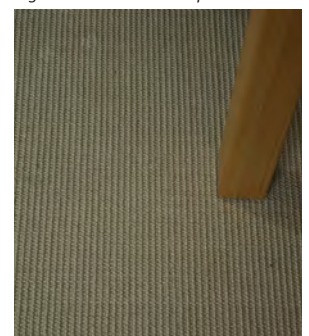
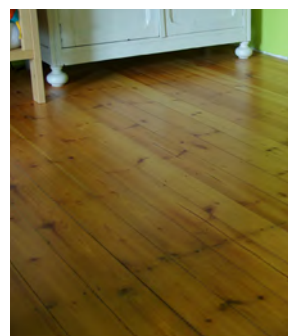

# Thermal inertia in housing renovation

N° of Sheet:  
**B15**  
 Cross-references:  
**B10, B16, B17, B19**  
 Appendix:  
 /



↑ Illustration 184 : Perforated concrete block



↑ Illustration 185: Perforated brick



↑ Illustration 186: Cellular concrete block

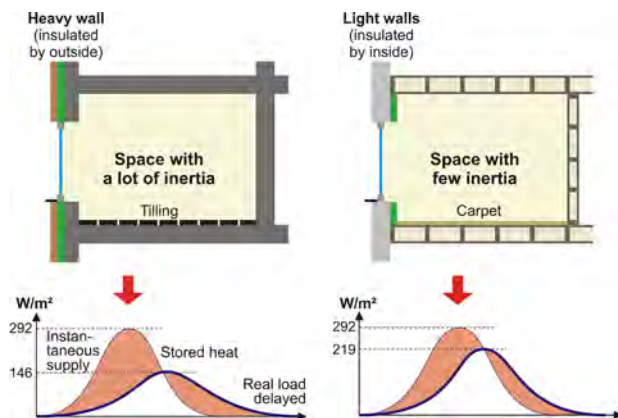

↑ Illustration 187: Relation between inertia and overheating:

1. Instantaneous contributions
2. Real delayed load
3. Stored heat
4. Restored heat

The thermal inertia can avoid or limit the overheating because it takes advantage of solar contributions. It stores the heat in the walls (storage) and returns it as soon as the air temperature is lower than the wall or floor. The inertia creates a thermal delay and dampens temperatures. This phenomenon slows the cooling at night as well as the warming during the day.

## 3. MATERIALS AND INERTIA

The French thermal regulation has set inertia classes for structural materials (interior walls, foundation slab, floor slab, etc.) since 2001.

These inertia classes are given here for information's sake. In renovating housing, one must aim for the highest classes of inertia whilst taking account of the structural problems that this may create.

### 3.1. Interior walls

Materials	Inertia category
solid or perforated concrete brick, 10 cm or more	8
solid or perforated brick of 10cm and more solid or perforated concrete block of 7.5cm coated	7
hollow concrete block of 10cm or more coated	6
brick 15cm or more coated cellular concrete block of 15cm coated	5
hollow brick of 5 cm or more coated solid gypsum tile of 6cm cellular concrete block of 7cm coated	4
coated brick of 3.5 cm	3
Gypsum board partition	2

### 3.2. Groundslab

Materials	Inertia category
solid concrete floor of more than 10cm with insulation in under-face	6
solid concrete floor of 5cm or more	5
floor of cellular concrete or alveolate concrete slab with screed of 4cm	5

### 3.3. Floor slab

Materials	Inertia category
solid concrete floor of 15cm or more with or without screed	6
hollow slab of concrete, 20 cm or more with screed	6
hollow slab of concrete < 20 cm with screed	6
Reinforced cellular concrete floor, 20 cm or more with screed	5
solid concrete floor of 5cm with insulation and wood covering	5
wood floor	1





## B.1. INCREASE THE THERMAL PERFORMANCES OF HOUSING

### Optimizing the solar protections

N° of Sheet:  
**B16**  
Cross-references:  
**B10 to B17**  
Appendix:  
/



Picture: Claude Rener, Provelo renovation

Whilst the admission of sunlight into a dwelling in winter makes it possible to reduce heating requirements, in summer and/or between the two seasons it is likely to cause overheating and major discomfort for the occupants.

Solar protection is thus of great importance when one works with a cold strategy, since it is necessary to be able to modify the dwelling's windows' exposures to the sun's rays according to the season and specific needs.

It also makes it possible to limit glare (thereby improving the occupants' visual comfort) and in certain cases to ensure the occupants' privacy or to completely black out a room.

#### 1. THE OBJECTIVES OF SOLAR PROTECTION

The choice of solar protection method depends on the objectives that one sets, bearing in mind that:

- the main objectives are to limit overheating and glare; and
- the secondary objectives are to increase the window's insulating power, to ensure the occupants' privacy, to be able to black out a room, and to decorate the windows.

↓ Illustration 188: Solar protection with green roof



↓ Illustration 189: Solar protections play also a role in the building architecture



#### 1.1. Main objectives

##### - Limiting overheating

During sunny periods the amounts of solar energy that is transmitted through the glazing can cause uncomfortably high temperatures for the occupants due to a greenhouse effect. Eastern and western exposures are often the ones that cause overheating problems.

##### - Limiting glare

Glare can perturb the occupant's ability to work, read, and engage in other activities in which vision plays an important part. In summer, it is due primarily to the sun's position in the sky at the start and end of the day with regard to the windows' eastern and western exposures.

In winter, in contrast, a southern exposure is likely to cause glare during the day.

#### 1.2. Secondary objectives

##### - Increasing the window's insulating capacity

The use of solar protection changes the windows' heat transmitting characteristics to various extents. Such an effect will be sought after in particular for winter nights.

##### - Ensuring the occupants' privacy

Many types of protection have another purpose in addition simply to improving energy performance.

One of them is to guarantee a certain amount of privacy (for south-facing façades that give onto the street, for example). This is the case of rolling slat blinds and Venetian blinds, for instance.

## Optimizing the solar protections

N° of Sheet:  
**B16**  
 Cross-references:  
**B10 - B17**  
 Appendix:  
 /

### 2. PROTECTIVE VEGETATION

The use of surrounding deciduous trees and other vegetation makes it possible to modulate the sun's contributions in line with the season.

The advantage of such plant screens lies in the fact that their annual growth cycles match the building's needs:

- in summertime: the shade that the plant screen provides is cooling and refreshing.
- in wintertime: the lack of leaves enables the sun's rays to reach the façade.

The advantages of deciduous vegetation in front of a southern exposure are:

- to shade the façades,
- to filter dust,
- to protect from warm winds, and
- to oxygenate and cool the air by evapotranspiration.

What is more, the additional living space that a garden or plantings provide participates considerably to the occupant's overall comfort, i.e., increased visual comfort, improved respiratory comfort, thermal comfort, and so on.

### 3. SOLAR PROTECTION

There are many types of solar protection:

- Permanent protection: special window panes, auto-adhesive films, etc;
- Stationary protection: awnings, sunshades, etc.
- Mobile devices: internal or external blinds, shutters, sliding panels, etc.

The aim of this information sheet is to propose some guidelines enabling the designer to make the best choice in line with the orientation and characteristics of the window, amongst other things.

#### 3.1. Type of solar protections

##### - Interior or exterior protection?

Exterior solar protection devices are as a rule more effective than interior ones, because they avoid the greenhouse effect that occurs behind the pane of glass. If the choice of interior protection is nevertheless made, the solar protection must be non-absorbing and reflective in order to deal with this problem.

External solar protection must withstand bad weather and vandalism (at person height). It withstands mechanical stresses better when it is fixed (sunshades, for example).

##### - Fixed or mobile protection ?

Being able to modulate solar protection proves interesting, for the need to protect a dwelling varies in the course of the day and year in line with the structure's orientation (for optimal luminosity, the contributions from outside should be limited in the summer and encouraged in the winter, for example).

To adapt to the needs for heat and cold, one can automate the modulation of mobile protection or make it the occupants' responsibility.

Fixed protection will prove an operable solution or not depending on the window's exposure and the sun's position in the course of the day or year:

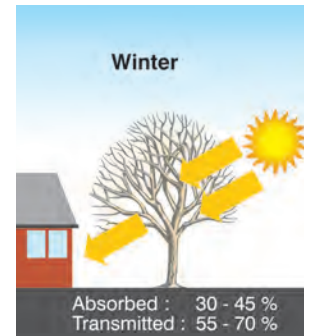
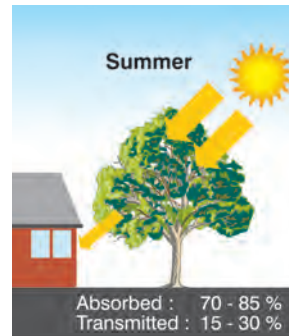

↑ Illustration 190: The interest of deciduous vegetation



→ Illustration 191: tree-shaded pedestrian way

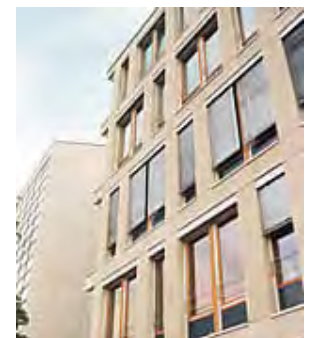
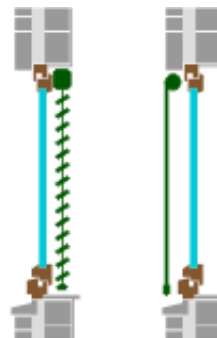

↑ Illustration 192 and 193: Two types of blind: internal or external

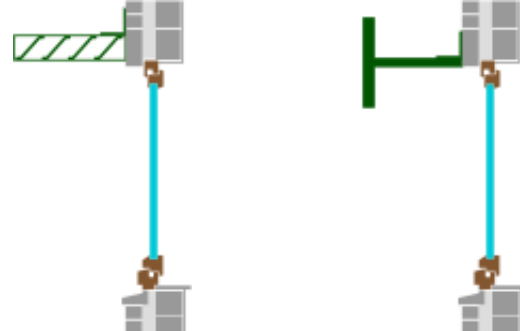

↑↓ Illustrations 194 and 195: Different types of fixed solar protections

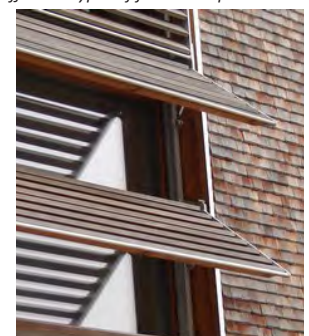



## Optimizing the solar protections

N° of Sheet:  
**B16**  
 Cross-references:  
**B10 - B17**  
 Appendix:  
 /

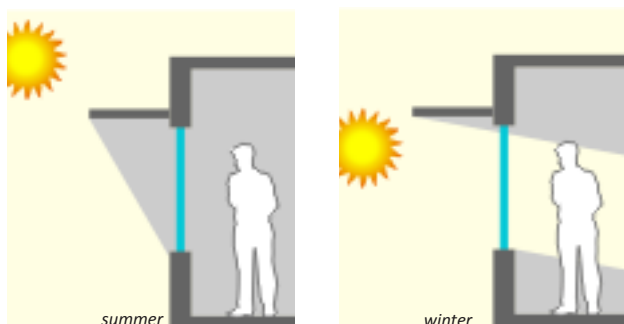

↑ Illustration 196 : The role of fixed solar protection

- For a southern exposure, horizontal fixed protection protects from glare and overheating in summer and allows one to make the most of the sun's rays in winter.
- For an eastern or western exposure, fixed protection is not effective, whether it is vertical or horizontal.

In our latitudes (temperate Europe), the probability of sunshine is less than 20 % in winter (that is, less than one day in five) and 50 % in summer (less than every other day). Consequently, permanent solar protection will regularly be detrimental to the occupant's comfort (both thermal and visual comfort).

### 3.2. Choosing solar protection in renovation

Keeping the priority objectives of the solar protection in mind, i.e., limiting overheating and glare, one should choose solar protection on the following grounds:

- according to the window's shape and orientation.
- so as to enable the dwelling to benefit from sufficient amounts of natural light (daylight) as much as possible.

In renovating housing, before even studying a solar protection system, one should verify:

- whether, depending on the window's exposure, the window's size is appropriate for the area of the room (see information sheet B18);
- the glazing's characteristics (light transmission and solar factor).

If exterior rolling slat blinds or shutters are present, one should study the possibility of keeping them whilst insulating them and treating the window box frames to make them airtight.

Southern exposure	Summer comfort	Solar heat gains (winter and mid-season)	Durability
Fixed protection like canopy	yes if the window is not too high	yes	yes
External mobile protection	yes	yes	yes if automated excluded on groundfloor
Internal mobile protection	no	yes	yes
Eastern and western exposures			
Fixed protection like canopy	no	yes	yes
External mobile protection	yes	yes	yes if automated excluded on groundfloor
Internal mobile protection	no	yes	yes





## B.1. INCREASE THE THERMAL PERFORMANCES OF HOUSING

### Natural nightcooling

N° of Sheet:  
**B17**  
 Cross-references:  
**B10,B11,B15,B16**  
 Appendix:  
 /



Picture: S.Trachte

Combining intensive ventilation with high thermal inertia is a key way to ensure summer comfort without having to use air conditioning. Indeed, intensive ventilation makes it possible to cool down the indoor air temperatures and masses of the rooms, primarily at night. This type of ventilation must not be mistaken for baseline hygienic ventilation, which is needed constantly to ensure good quality indoor air.

#### 1. PRINCIPLE

In summer, it is possible to make use of the outside air to cool down a building.

The possibility of establishing effective intensive ventilation depends upon several parameters, i.e.:

- the existing building's architecture, which will or will not make it possible to create major air movements;
- the immediate surroundings: exposure to wind, noise, air pollution, etc.

As wind conditions and the project's immediate surroundings are given specific to each renovation project, we shall speak here only of the various interior engineering strategies and openings (their size and number) allowing effective intensive ventilation.

#### 2. NATURAL VENTILATION SYSTEMS (not mechanical)

In renovation, when the renovated dwelling is heavily insulated and has high inertia, one can content oneself with putting in what are known as "natural ventilation" systems, i.e., non-mechanised systems that allow one to create air movements and to cool the interior volumes during the night.

Air movements in the building can be created in two ways, as follows:

##### 2.1. 2.1. Arrangement allowing cross draughts

A cross-draught arrangement consists in laying out the dwelling between two opposite façades with, ideally, one façade exposed to the prevailing winds so as to create a draught by taking advantage of the wind pressure.

This type of strategy should be encouraged when renovating collective housing, for it makes it possible not only to cool the dwelling in the summer but also to take advantage of the various views and luminosities.

Type of ventilation	Air flow rate
hygienic ventilation	+/- 1 change of air per hour
intensive ventilation	4 changes of air per hour in occupied rooms 8 to 10 changes of air per hour in non occupied rooms



↑ Illustration 197: Type of natural ventilation - Air flows

### Natural nightcooling

#### 2.2. Arrangement allowing a vertical flue (or stack) effect

The flue or stack effect, which is particularly effective in winter and during summer nights, is the rising movement of the indoor air in a building because it is warmer and thus lighter than the outside air.

Creating a flue or stack effect calls for including a communicating structure between floors in the dwelling, which is done ideally via the staircase.

This strategy should be encouraged when renovating individual dwellings.

#### 2.3. Specificities of the openings

In both types of natural ventilation, the openings used for night-time ventilation will have to:

- keep the risk of intruders down to a minimum;
- be sufficiently sturdy to withstand high winds; and
- prevent the admission of water in the case of storms or heavy rain.

### 3. SCHEMES LINKED TO HYGIENIC VENTILATION

In cases of very high temperatures or long heat waves, non-mechanised ventilation schemes are not always enough to bring indoor temperatures down to comfortable levels.

That is why one can also take advantage of the hygienic ventilation system (modes C and D) to discharge the heat that builds up during the day.

In such a case, the ventilation system will have to be connected to:

- an outside temperature gauge that will trigger the system when a predefined  $\Delta t$  between the indoors and outdoors is reached; and
- a clock to programme the system for a certain number of minutes or hours.

Ventilation mode D or the double flux mode can also be combined with a ground heat exchanger. The ground heat exchanger and its connection to a ventilation system are described in information sheet B27.

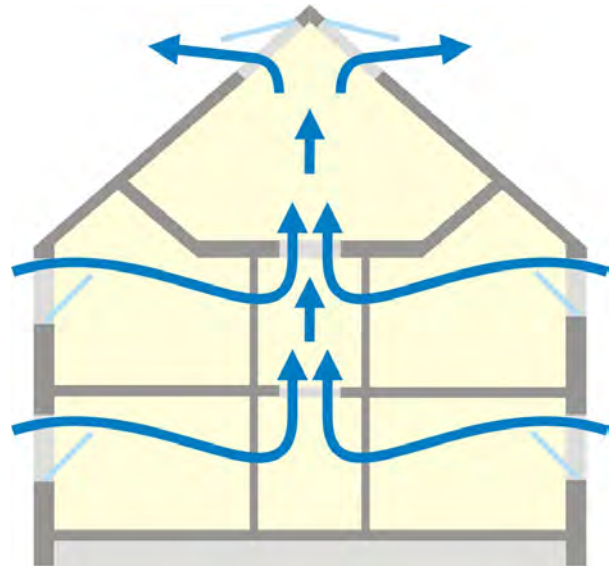

↑ Illustration 198: Pléiade House - Louvain la Neuve - Belgique  
Intensive ventilation by night by chimney effect

*In dwellings, intensive nighttime ventilation in the summer creates indirect energy savings. Indeed, intensive ventilation coupled with high inertia and solar protection systems improves summer comfort noticeably and makes it possible to avoid relying on air conditioning, which is found more and more frequently in homes.*

*What is more, the designer must get the occupants to take responsibility for heat management, to adopt the right habits, e.g., to open windows at night in the summertime and close them during the day if the outside temperature is higher than the indoor temperature.*



## B.1. INCREASE THE THERMAL PERFORMANCES OF HOUSING

### Optimizing the window conception

N° of Sheet:  
**B18**  
Cross-references:  
**B10, B12, B16**  
Appendix:  
/



Picture: S.Rouche

Openings onto the outdoors are indispensable for indoor comfort (daylight, thermal inputs, acoustics, and indoor/outdoor ratio).

However, windows' surface areas are responsible for large heat losses in winter and undesirable heat gains in summer.

The choice, orientation, and size of each window are thus the result of striking a balance amongst these parameters.

#### 1. THE WINDOW: A COMPROMISE BETWEEN VISUAL AND THERMAL COMFORT

The window plays a vital role in thermal and visual comfort. However, the window is the most critical of all the elements of the envelope because of its various functions, for, in addition to its insulating qualities, it must offer a view onto the outside world, be able to open and close perfectly, and, what is more, admit a maximum amount of solar energy.

##### 1.1. Visual comfort

*“Visual comfort is a subjective impression linked to the amount, distribution, and quality of the light that enters the dwelling...”.*

Source: *Traité d'Architecture et d'Urbanisme bioclimatiques.*

This means that visual comfort depends upon a set of both quantifiable physical parameters (lighting, luminance, contrast, glare, etc.), but also physiological and/or psychological parameters linked to the occupant, as well as parameters specific to the dwelling's environment (possibility of views, quality of what is seen, etc.).

In sustainable renovation, the designer can improve the occupant's visual comfort considerably by working on the following parameters:

- the outdoor views that are offered to the occupant
- the level of lighting in the room
- the harmonious distribution of light
- a pleasant colour of light
- the absence of bothersome glare and/or shadows

However, visual comfort is a subjective impression that is also influenced by each individual's culture and history.



↑ Illustration 199: «Windows is the link towards the world outside»  
Le Corbusier.

**1.2. Thermal comfort**

An occupant’s thermal comfort is directly linked to the thermal performance of the frame/glazing complex, to the window’s size in relation to the room and to the window’s orientation. These different parameters are described in detail in the following paragraphs.

**2. OPTIMISING WINDOWS IN RENOVATION**

In lot of renovation projects, the dimension and shape of the windows will not be changed. But in few cases, especially in case of heavy renovation, the dimension, the shape and maybe the location could be changed if those modifications mean an appreciable improvement of thermal and visual comforts.

**2.1. Preliminary verifications**

In renovating dwellings, before making any improvements one must verify:

- the distribution of windows on the façades;
- the dimensions and shapes of the windows in relation to the rooms that they light; and
- the state of each frame and performance of the frame/glazing complex.

**- Distribution of windows (Mid-Europe)**

A distribution of glazed areas according to the façades’ orientations. An unequal distribution has considerable influence on heat gain. Indeed, for example, the following distribution yields an average saving of 1500 kWh/yr over an equal distribution over the four façades:

- Southern façade: 50 % of the area is glazing;
- Eastern and western façades: 20 % of the area is glazing;
- Northern façades: 10 % of the area is glazing.

**- The windows’ sizes and shapes (Mid-Europe)**

When the designer assesses the windows’ sizes and shapes, he/she will pay attention to:

**- The amount of glazing according to the façade’s orientation**

The surface areas proposed below make it possible to make the best use of the sun’s contributions whilst limiting heat loss and the risk of overheating:

Exposure	Percentage of glazing recommended in relation to the room’s surface area:
South	> 15% Solar protection systems will be necessary if one exceeds 18%
West	between 10% and 18%
East	between 10% and 18%
North	between 10% and 18%

**- The window’s height and shape**

For a constant surface area, the windows’ lintels must be placed as high as possible; the following “depth of room/lintel height” ratio is recommended:

bedrooms	< 2
living room	< 2.2



↑ Illustration 200 : Modification of existing openings



↑ Illustration 201 : Conservation of existing openings

## Optimizing the window conception



Existing opening



Solution 1 : external insulation



Solution 2: external insulation



Solution 3: internal insulation

↑ Illustration 202: Modification of existing openings - Various solutions

It is important, however, to point out that changing a bay may prove costly, even if it is interesting – even necessary in some cases – from a thermal point of view.

The change in the window’s bay may also be done whilst taking account of other important parameters of the renovation, to wit:

- the aesthetic composition of the façades
- the relationship with the garden, if there is one
- nearness to the street or public areas (management of privacy)
- the occupant’s visual comfort.

### - The state of the frame and performance of the frame/glazing complex

The designer will evaluate both the state of the frame and the performance of the entire frame/glazing complex.

The state of the frame is linked to:

- the maintenance and state of the frame itself (absence of mould and fungi, absence of corrosion, absence of deformation);
- the proper working of the hinges; and
- the air tightness of the joints and gaskets.

The thermal performance of the frame/glazing complex is linked to:

- the glazing’s thermal performance (and the gas that fills the gap between the panes);
- the thermal performance of the spacer; and
- the quality of workmanship in placing the frame in the wall (continuity of insulation).

Generally speaking, in renovation,

- old window frames that lack thermal breaks and are not airtight will be replaced;
- single glazing or “first generation” double glazing will be replaced by higher performance double glazing, even triple glazing.

## 2.2. Different renovation choices

After this first analysis, we may consider two cases:

### - Keeping existing bays

When an existing bay is kept, one has two possibilities:

- replacing the frame/glazing complex if these two elements are not very efficient; or
- keeping the frame and replacing the glazing if the frame is in good condition and insulates well.

### - Modifying existing bays

Modifying an existing bay will necessarily involve replacing the entire frame/glazing complex.

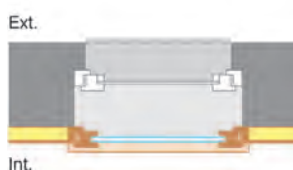
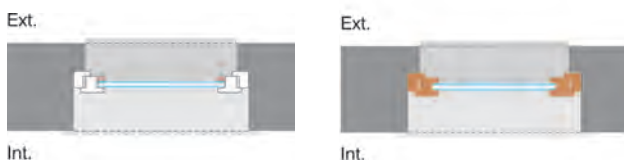

↑ Illustration 203 : Conservation of existing openings

# Optimizing the window conception

## 3. THE GLAZING

### 3.1. The glazing's performance

When one replaces the glazing of a window, one must pay attention to the glazing's performance levels. This performance is defined by the heat transmission (U-value).

But the glazing's performance is not limited, however, to its insulating ability. One must also take account of the following notions:

#### - Solar factor (g value)

The solar factor is the fraction of incident solar energy that goes through a window and its solar protection, if there is one. This value actually represents the level of protection that the glazing and its shading offer against overheating in the summer and its energy-absorbing role in the winter.

#### - Light transmission (LT)

Light transmission is the fraction of the solar radiation that goes through the glazing if one considers only the visible part of the solar spectrum. This value characterises the glazing's transparency.

When renovating housing, one must find a compromise amongst a high solar factor in winter, a low solar factor in summer, and high light transmission throughout the year. The solution consists in choosing clear glazing with a high g-value and placing solar protection to avoid overheating in the summer.

### 3.2. Type of glazing

The table below gives the characteristics of the main types of glazing used in housing.

Type of glazing		U-value W/m <sup>2</sup> K	Light transmission %	Solar factor %
simple	bright 8mm	5.8	90	86
double	bright low emissivity	1.6	70	55
	bright low emissivity + insulating gas	1.1 à 1.3	70	55
triple	low emissivity with argon	0.6	69	53

In renovating dwellings so as to achieve high envelope performance objectives, one will choose at least

- for mid-european countries : a low emissivity clear double glazing with an u-value of 1.1W/m<sup>2</sup> K;
- for northern countries : a low emissivity triple glazing with an U-value below 1.0 W/m<sup>2</sup>K

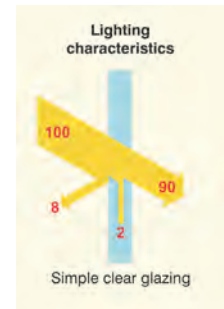
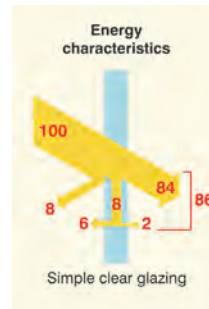

↑ Illustrations 204 and 205 : Solar Factor and Light transmission

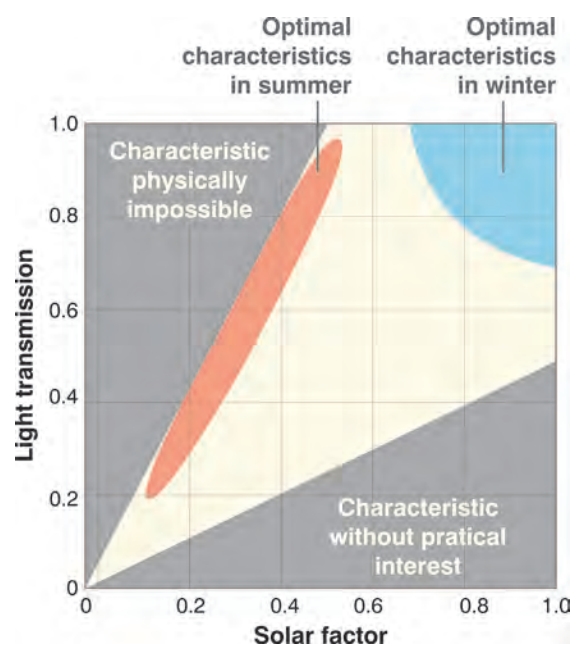

↑ Illustration 206 : Optimization between the two factors

↓ Illustration 207 : Lining of the existing frame

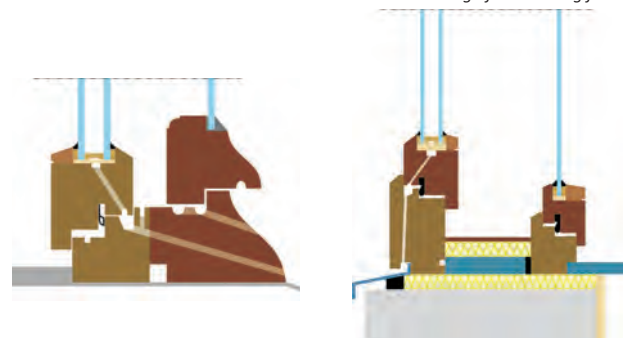

↓ Illustration 208 : Mobile overglazing of the existing window

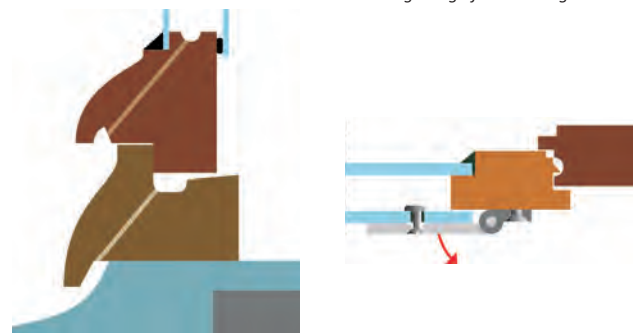



# Optimizing the window conception



↑ Illustration 209:  
Frame in aluminium



↑ Illustration 210:  
Frame in PVC

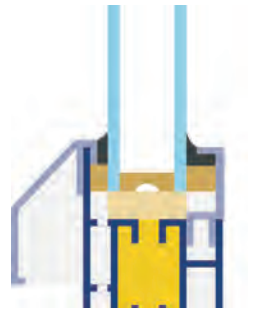

↑ Illustration 211:  
Frame in steel



↑ Illustration 212:  
Frame in wood and aluminium



↑ Illustration 213 :  
Frame in wood and cork



↑ Illustration 214:  
Frame in PUR

## 4. THE FRAME

### 4.1. Type of frame

In replacing window frames one should pay attention to the following performances:

#### - Thermal performance

With high-yield glazing, the frame becomes the least insulated part of the window. One should thus take care to choose a high-performance frame with a U value of at least 1.8 W/m<sup>2</sup>K.

#### - Acoustical performance

When it comes to indoor comfort, acoustic performance becomes a priority in housing renovation, especially in busy, high-density areas.

#### - Water and air tightness

Air and water tightness are important notions when considering overall performance. Air and water tightness depend on the frame's profile (number of coinings and peripheral seals).

#### - Environmental assessment

Depending on the material used, the frame will have a greater or lesser life-cycle impact on the environment ("from cradle to grave"):

- depletion of energy resources
- depletion of non-energy resources
- greenhouse gas emissions
- acidifying gas emissions
- recycling potential
- lifespan
- etc.

In the sustainable renovation of housing one must strike a balance amongst these various performances.

Material	Thermal performance	Environmental assessment
Frame made in local wood	1.8 W/m <sup>2</sup> K	++
Frame made in tropical wood	1.8 W/m <sup>2</sup> K	-
Frame made in wood / aluminium	1.8 W/m <sup>2</sup> K	+
Frame made in aluminium	2.9 to 4.5 W/m <sup>2</sup> K	-
Frame made in PVC	1.6 to 2.2 W/m <sup>2</sup> K	--

↓ Illustration 215: Environmental labels for wood products







## B.1. INCREASE THE THERMAL PERFORMANCES OF HOUSING «Passivhaus» standard in housing renovation

N° of Sheet:  
**B19**  
 Cross-references:  
**B10 à B18**  
 Appendix:  
 /



Given its two objectives, namely, to increase indoor comfort whilst limiting energy consumption greatly, renovation that aims to achieve the passive standard is the first and most important step towards sustainable renovation. However, it is not the “ready-made” solution to all of the issues that revolve around sustainable housing renovation, e.g., water management, waste management, environmentally and health friendly materials, integration in the socio-economic context, and so on.

We can only advise a comprehensive approach that involves both striving to achieve the passive standard and dealing with the other stakes riding on sustainable building.

### 1. WHAT IS THE “PASSIVE HOUSE” STANDARD

According to the Passivhaus-Institut in Darmstadt, a passive building is a building that achieves a pleasant indoor temperature without conventional heating in the winter and without air conditioning in the summer.

In figures, the passive house can be described as follows:

- Heating need of 15 kWh/m<sup>2</sup> per year, or 1.5 l of heating oil equivalent per m<sup>2</sup> on average.
- Total energy needs (heating, hot water, ventilation, and household electrical appliances) below 42 kWh/m<sup>2</sup>/yr.
- A primary energy expenditure index (for heating, sanitary hot water, ventilation, and electricity) that is below 120 kWh/m<sup>2</sup> per year.

#### 1.1. Building principles

The basic principles guiding the renovation project towards the passive standard are to reduce heat loss on the one hand and to manage the direct contributions of solar energy on the other hand. These principles can be satisfied by following the rules spelled out in the other information sheets in this chapter and which can be summarised as follows:

##### - Choose a compact building

The choice of the ratio surfaces /volume will affect the need for heat and the power consumption. Indeed, more the relationship between surface and volume are small, more surface to be heated is small and less the thermal losses are important.

##### - Have the building face south

Another measure to minimise heat loss is to have the building facing primarily south and having a large glazed surface area with a southern exposure whilst limiting overheating by means of solar protection devices.

These large glazed areas make it possible to capture solar energy, which will generate heat inside the dwelling once it is admitted inside.

The glazed surfaces' light transmission coefficients must be greater than 50 %.

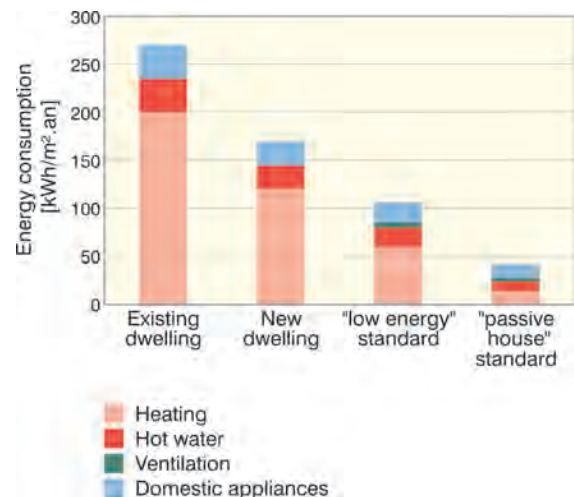

↑ Illustration 216 :  
 Energy consumption for the systems in various types of construction  
 Source : Passivhaus platform vzw, Anvers.

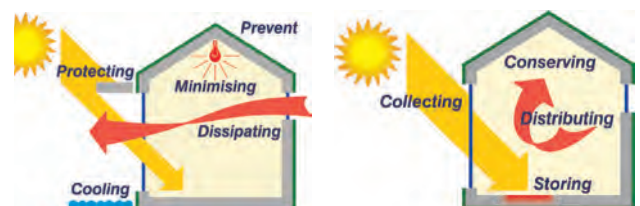

↑ Illustration 217 and 218: Heating and cooling strategies.

## B.1. INCREASE THE THERMAL PERFORMANCES OF HOUSING

### «Passivhaus» standard in housing renovation

N° of Sheet:  
**B19**  
Cross-references:  
**B10 à B18**  
Appendix:  
/

#### - Insulate the envelope heavily

To minimise heat loss through thermal transmission, the passive house requires an extremely well insulated envelope. (See sheet B12- table showing Uvalues)

#### - Limit thermal bridges

A heavily insulated passive house is very sensitive to thermal bridges, for the slightest defect in the envelope can generate the need for too many additional calories. The objective is thus to eliminate as many thermal bridges as possible.

It should also be pointed out that the unresolved thermal bridges are taken into account in calculating the house's heat losses.

#### - Make the envelope extremely air tight

The envelope of a passive house must be as airtight as possible so as to avoid ventilation heat losses. That is why the airtightness of a passive house must be checked by the blower door technique. This is mandatory.

The air tightness of the envelope is expressed by the amount of air (number of times that the indoor air is renewed) that must be blown in to keep a pressure difference of 50 Pa in the building. This is the n50 value. The n50 value required to meet the passive standard's air tightness criterion must be 0.6 m<sup>3</sup>/h for a pressure difference of 50 Pa.

- Illustration 219 :  
Limiting thermal bridges.
- ↓ Illustration 220 :  
«Blower door» test.
- ↘ Illustration 221 :  
Anemometer.

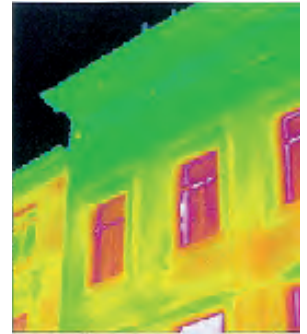

### 1.2. Basic ventilation and heating principles

Since the envelope of a passive house is extremely insulated and air tight, a mechanical ventilation system (double flow) is necessary to maintain the indoor air's good quality. This ventilation system is obligatorily coupled with a high-yield heat recovery device (from 75 to 95 % of the heat is recovered) and, if necessary, a ground heat exchanger.

On the other hand, a conventional heating system is useless, as it will be overscaled, given the passive house's very low heating needs.

However, a low level input is necessary in some rooms during the coldest periods. This will then be provided by the ventilation system, where the back-up heat can be provided by electrical resistance elements, heat exchangers linked to the sanitary hot water tank, or heat pumps working with the extracted air. If necessary, a back-up wood-burning stove may be placed in a central area of the dwelling, as a rule in the sitting room. In this case, the heat will be distributed around the house by ventilation.

### 1.3. Basic principles for sanitary hot water

In a passive house, the question of a back up for heating the sanitary hot water crops up. Indeed, since a passive house's need for heat for space heating is very limited, the need for heat for the sanitary hot water becomes proportionately more important. In some cases, the heat need for hot water can account for 70 % of the building's entire need for heat. One must thus pay particular attention to this aspect, especially since, unlike heating, one needs hot water all year.

The solution that is given priority is to install thermal solar panels, which will cover between 40 and 50 % of the needs. A back-up heat source is thus necessary. It will be either electrical or combined with the heating system:



↑↓ Illustrations 222, 223 and 224 :  
In passive house, the need of hot water takes more importance.



## B.1. INCREASE THE THERMAL PERFORMANCES OF HOUSING

### «Passivhaus» standard in housing renovation

N° of Sheet:  
**B19**  
Cross-references:  
**B10 à B18**  
Appendix:  
/



↑ Illustration 225 : Heat recovering - Balance ventilation system.



↑ Illustration 226 : Heat pump - source : [www.Viessmann.be](http://www.Viessmann.be).

#### - A small condensation gas furnace

The domestic hot water is preheated by solar panels. The additional heat is then provided by a small condensation furnace (maximum of 15 kW) that runs on natural gas. This furnace is connected to the boiler (in which case it works under high yield operating conditions) or to the ventilation system to preheat the air that enters the house (low yield operating conditions).

#### - Wood pellet stove

The principle of this heating system is simple: It is a specially designed stove for low power output that burns wood pellets. It heats the water in a water tank that distributes the sanitary hot water and preheats the incoming air by means of a heat exchanger.

Solar panels can also help to heat the water.

Wood can also be an interesting fuel for the following reasons:

- it is a renewable energy source that does not have a negative influence on the greenhouse effect (emission of CO<sub>2</sub>) when it burns (if the combustion occurs correctly).
- it has a high heat capacity (5 kWh/kg). For the sake of comparison, we can say that two kilograms of wood pellets have the same energy value as a litre of heating oil.

#### - Air/water heat pump

An air/water heat pump is coupled to the ventilating system's fan with about 80 % heat recovery.

With a power rating of a mere 1.5 kW, it transfers the residual heat in the waste air towards the sanitary water tank.

Then, another exchanger placed between the hot water and pulsed air provides the additional heat needed for the home. As the heat pump does not suffice to provide all the energy needed, a solar or electrical back-up system is also necessary.

#### - Air/air heat pump

In this case, the two functions (hot water and heating) are separate.

For the hot water, solar panels heat a water tank. For the heating, an air/air heat pump is coupled to the fan. It transfers the residual heat in the waste air directly to the incoming air instead of transferring it to the water tank as in the previous case.

### 1.4. Cultural and social aspects

#### - Impact on winter comfort

One of the consequences of the energy performance characteristics of a passive house's envelope and ventilation system is the uniformity of the indoor temperatures, which remain around 20°C.

Indeed, it is not obvious at first glance to keep a lower temperature in the bedrooms than in the living room. This uniformity may strike certain people as a drawback and may call for adjustment.

#### - Impact on the summer comfort

Given their high degree of insulation and, for the most part, low thermal mass (due to the use of a wood frame), passive houses are sensitive to overheating as soon as spring comes around.

It is thus advisable to provide for:

- solar protection, preferably mobile devices, on the exposed façades;
- solid interior floors so as to increase the dwelling's inertia;

and

- the possibility of intensive ventilation at night.

#### ***- The occupant's responsibility in dealing with more advanced technology***

Building or renovating according to the passive standard often leads to the use of special advanced technology: a double-flow ventilation system (whether or not coupled with a ground heat exchanger), back-up heating installation (heat pump or more traditional system), back-up sanitary hot water heating system by means of thermal solar panels, etc.

This more advanced technology requires the occupants to invest more in their dwelling, notably when it comes to maintenance, but also when it comes to monitoring the installations' good working order.

## **2. DOING «PASSIVE HOUSE» RENOVATION**

Renovating a dwelling to make it passive is no mean feat in terms of both the work to do and difficulties of implementation that one will run across and financing (large additional cost due primarily to the layers of insulation, placement of triple glazing, installation of special technology, pressurisation test, and so on).

Some existing elements, such as the dwelling's southern exposure, good compactness, and party walls, are elements that can help the designer reach the passive standard without too much trouble, provided that these elements are favourable for this.

Turning the dwelling into a passive house must nevertheless remain the chief objective that all homeowners and designers who are conscious of energy issues must strive to attain.

However, this objective must be incorporated into a more comprehensive, civic-minded approach that takes account of other sustainable development criteria. Indeed, is it sustainable to renovate a house according to the passive standard and then commute to work every day by car?

## B.2 REDUCE FOSSIL ENERGIES CONSUMPTION

- B20 - Optimizing the heating system
- B21 - Optimizing domestic hot water
- B22 - Heat pump for heating production
- B23 - Hot water production by solar energy
- B24 - Optimizing the lighting system
- B25- Renewable energies for generating electricity
- B26 - Heat recovery on ventilation system
- B27 - Air pre-heating by airground exchanger

Arch: modelmo architecture, Picture : Marie-Hélène Grégoire







## B.2. REDUCE FOSSIL ENERGIES CONSUMPTION

### Optimizing the heating system

N° of Sheet:  
**B20**  
 Cross-references:  
**B10 to B19, B21 to B23**  
 Appendix:  
 /

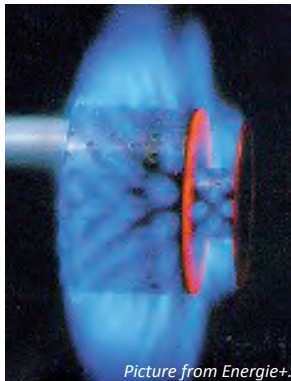

Picture from Energie+.

In temperate Europe, primary energy consumption in housing varies depending on the energy vector between:

- 18 000 and 28 000 kWh per year for apartments
- 24 000 and 35 000 kWh per year for private homes

The traditional heating systems have some disadvantages:

- consumption of fossil energies (oil, gas, electricity);
- emission of atmospheric pollutants (CO<sub>2</sub>, SO<sub>2</sub>,...)

In terms of sustainable renovation, priority should be given to a high performance envelope in order to reduce the need for heat, and if needed, an efficient heating system with a limited use of primary energy and emissions.

#### 1. PRELIMINARY COMMENT

Optimizing any existing heating system can only be done once the energy performance of the building envelope has been improved. This entails:

- reinforcing insulation of the façades, the roof, and the floor slab;
- improving airtightness of all external walls;
- elimination of thermal bridges.

In the context of sustainable renovation, the heating system should be reviewed taking into account the following aspects:

- new distribution of the premises and their functions;
- energy performances of the envelope;
- the general condition and special aspects of the heating system;
- the type of fuel used.

Four elements play a role in the quality of the heating installation:

- the system for producing heat
- the distribution
- the emission system or the radiators
- the regulation of the system

*But first of all, in housing, be it individual or collective, an effective installation is a simple installation, easy to use and easy to manage by the occupant.*

#### 2. BASIC PRINCIPLES

In renovation, when a passive standard can be achieved by working on the outer walls and the interior fittings, the existing heating installation is no longer necessary. The existing boiler can be maintained as a back-up for producing hot water. Conversely, when only a low-energy standard can be reached in renovation, there is a need for energy for heating of about 30 to 60 kWh/m<sup>2</sup>/year -- the current heating installation should be maintained and optimized in view of the new needs.



↑ Illustration 227 : Principles of heating strategy.

**Remark :**

*Sometimes, it's difficult to make some improvements on the thermal performances of the building envelope, especially with the old buildings.*

*In this case, it is much better to improve the heating system; making it really efficient and using renewable energy.*



↑ Illustration 228 : Traditionnall radiators.



↑ Illustration 229 : Radiator valve.

# Optimizing the heating system

---

It is also important to identify an optimum given the typology of the housing unit or units that are to be renovated.

In collective housing: the choice of a centralized or decentralized installation will have an impact not only on the general performance, but also on the possibilities of combining the installation with other «renewable» systems such as the installation of solar panels, cogeneration and the like.

To optimize the installation, depending on the analysis of the various factors listed above, the following can be considered:

- replacing the heat production system
- improving distribution
- improving the radiators
- improving or installing regulation

### 3. VERIFICATION AND MAINTENANCE OF THE SYSTEM FOR PRODUCING HEAT

Before making a choice about keeping or replacing the heat production system, check the following aspects and/or do maintenance of the system:

#### *- Improving regulation of fuel*

Increasing the air supply improves combustion efficiency. On adjusting the burner, the optimum is reached by increasing the air supply to a maximum before the point when unburned residue appears. In the winter, as the volume of oxygen falls, one may tend to adjust the supply of air for that period and leave it there for the entire year, but this is less efficient.

#### *- Improving evacuation of fumes*

Putting in or adjusting the damper improves the efficiency of combustion and prevents too much condensation of water vapor from the fumes in the chimney by determining the optimum speed of the fumes.

#### *- Adjusting the regulation of the burner*

It is frequent to see effective high-performance burners (old or new) whose advantages are not really used: not closing the motorized damper when the burner is not operational and not regulating the cascade control system in a dual stage burner. In the first case, control of the motorized valve should be verified (if there is one) to reduce cooling losses when not in operation. In the second case, adjusting the cascade to control the two aquastats set at different temperatures (on the outlet and the return collector) keeps the burner from continually operating at full regime.

#### *- Reducing the power of the burner*

If the boiler is oversized (which is often the case in old installations), it is interesting to review the burner characteristics to reduce heating power (except for atmospheric gas burners):  
For fuel oil boilers: by changing the characteristics of the spray nozzle (flow of the nozzle / pump pressure), for gas boilers: by reducing the gas pressure.  
Nevertheless, this reduction is limited to 60-80 % of nominal power depending on the model.

#### *- Replacing the burner*

Old pulse burners (for gas or fuel oil) cannot be regulated. If they are showing signs of fatigue (frequent clogging), it is time to think about replacing them.

# Optimizing the heating system

N° of Sheet:  
**B20**  
 Cross-references:  
**B10 to B19, B21 to B23**  
 Appendix:  
 /

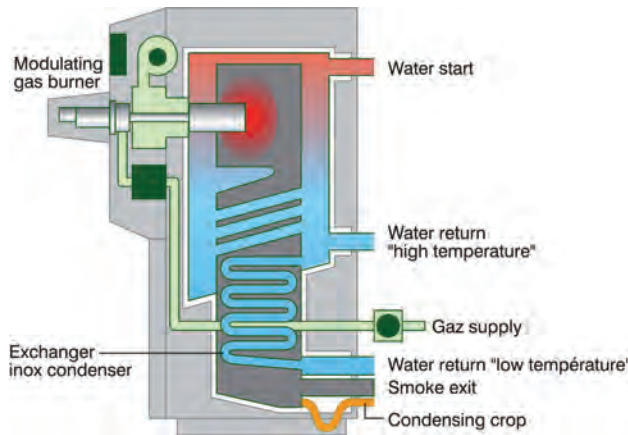

↑ Illustration 230 : Working principle of a condensing gas boiler.

The first question to ask when a burner is reaching the end of its service life is: should just the burner be replaced and not the boiler? There are two answers: Yes, if the idea is to improve combustion and to ascertain that the burner will be compatible with a new boiler in the future; no, if the burner-boiler system is obsolete.

Since boilers are developed in association with a few burners only, the improvement in combustion efficiency is limited when only the burner is replaced (about 1 to 2 %). Replacing the burner also reduces cooling losses.

**- Reducing the operating temperature of the boiler**

Adjusting the boiler setting in view of the outdoor temperature (sliding temperature) reduces losses when it is not in operation, but this is a touchy adjustment. The manufacturer should be consulted before doing this to avoid discomfort if certain hydraulic circuits are disturbed and condensation that can cause internal corrosion.

**- Sealing and re-insulating the boiler**

Identifying any leaks and sealing them off reduces losses and improves the efficiency of combustion by the additional air supply. Similarly, insulating the cover reduces losses.

↓ Illustration 231 : Heat pump - source : www.viessman.be.



↓ Illustration 232 : Wood boiler - condensing or not.



www.okofen.be.

## 4. REPLACING THE SYSTEM OF PRODUCTION

Heat production systems differ both by the energy vector (fuel oil, gas, electricity, biomass, renewable energy) and by their efficiency.

In sustainable renovation of housing, when the demand for energy and heat is between 30 and 60 kWh/m<sup>2</sup>/year:

- The use of electric heating should be avoided because of the mediocre efficiency of the generation network, so should the use of a fuel oil heating system;
- Heating using municipal gas (condensation boiler), wood heat, and heat pumps will be given priority;
- Connecting with the existing network should be encouraged if that network is powered by a high-performance technology from the standpoint of the environment, like cogeneration.

**Example:**

Power of heating: 25kW

Energy needs: 40.000kWh/year

Average prices of the energy vectors 0.045€/kWh for gas, 0.110€/kWh for electricity, 0.035€/kWh for wood and 0.050€/kWh for fuel

Type of production	Consumption kWh_prim/year	Energy bill €/year	Global Warming Potential kgCO2/year	Investing cost €
Fuel boiler	49 159	2 458	15 190	4 000
Traditionnal gas boiler	49 159	2 212	12 339	4 000
Condensing gas boiler	44 778	2 015	11239	5 500
Wood boiler	56 532	1 979	2 261	11 000
Heat pump	39 672	1 658	4 553	30 750*

Source : Info fiche Eco-construction «Choisir le meilleur mode de production de chaleur», IBGEBIM, Bruxelles, 2007.  
 (\*): There are less expansive solutions available. This price is an average between various systems.

# Optimizing the heating system

### 5. IMPROVING DISTRIBUTION

Improving the distribution network should:

- limit losses of heat between the production system and the radiators;
- limit electricity consumption of circulators.

To achieve this, it is recommended to:

- limit the length of pipes and insulate them;
- choose a variable speed circulator that will cut off the system when there is no demand for heat.

#### **- Limiting the length of pipes and insulating them**

*Example :*

*Loss from 1 m of a pipe 1 inch in diameter, carrying water at 70°C is the equivalent of the consumption of a 60 W light bulb, and insulation can reduce this loss by 90%.*

In the example above, it is easy to understand that that limiting and insulating distribution pipes is indispensable.

In renovation, limiting the length of pipes is not always possible; it essentially depends on the rearrangement of indoor areas (case-by-case). For this reason, we will limit our discussion to insulation of pipes.

The pipes (straight sections, curves and branches) to be insulated in an existing dwelling are the following:

- All pipes in the ground, outside or in premises that are not part of the heated part of the building (boiler room, attic, basement, garage, ...);
- All pipes in false ceilings, technical premises or shafts or embedded in elements of the construction, even in the protected volume of the building;
- All heat pipes with a diameter of more than DN40 going through heated premises to serve other premises.

In addition, if the installation includes accessories with a diameter of more than DN40, these too should be insulated.

Generally speaking, insulation of the pipes is done using pre-shaped jackets in mineral wool or synthetic foam (polyurethane, polystyrene, synthetic rubber etc.). Some more ecological alternatives exist, such as sleeves filled with cellulose flakes, but this type of insulation is harder to implement.

#### **- Reducing the flow of the circulators**

For the moment, there is a tendency to oversize circulators. Measurements have shown that on the average, the circulators have a flow that is 2.5 times too high as compared to needs. This oversizing is due to the absence or inaccuracy of the calculation of friction losses, as well as safety margins taken in the choice of equipment.

To avoid oversizing the circulators, we recommend choosing an electronic circulator that can be adjusted for speed to suit the needs. A gain of 25 to 50% of consumption of circulators can be obtained in this way.

Example: for a 60 kW boiler, a gain of 180 to 350 kWh/year.

In addition, if the operation of the circulators is integrated in the regulation, their operating time can be cut in half.

In renovation, one should check whether the power of the circulator and the needs correspond by doing an accurate calculation of friction loss. If the circulator is oversized, and it is not integrated in the boiler, it should be replaced by:

- a Label A circulator with a reduction of electric power from 50 to 70% as compared to an average circulator;

#### **Comment on the use of wood (construction, installation, fuel for heat)**

*In terms of sustainable development, heating with wood must clearly remain a minority alternative on a European scale limited to highly wooded areas.*

*For a few years now, wood has become generally very popular: wood frame constructions (which can reach a good energy performance easily), increasing use of wood fibre and particle board (OSB, MDF, insulation), interior furnishings and furniture, wood-burning heat (stove or pellet burning boiler). But this popularity, legitimate as it may be, could have an important impact on the environment:*

- *If used intensively (wooden frames, panels, furniture, installation, fuel), it is obvious that wood is no longer renewable as a resource. This is already the case for certain manufacturers of granulates who grow young trees as intensive crops and then cut them down to grind them;*
- *If the majority of families were to use wood as fuel, air pollution would increase significantly, because of the emissions specific to wood (CO, NOx, fine particles, soot) in greater quantity than for gas, notably;*
- *Wood is often presented as an ecological material with a neutral CO2 balance: the quantity of CO2 that it accumulates during growth by photosynthesis is equivalent to the quantity of CO2 that is rejected when it is burned. However, the manufacture of particle board and insulation panels requires considerably more energy than some traditional materials.*



↑ Illustration 233 : Insulation of the distribution network.

# Optimizing the heating system

N° of Sheet:  
**B20**  
 Cross-references:  
**B10 to B19, B21 to B23**  
 Appendix:  
 /



↑ Illustration 234 : Radiators.

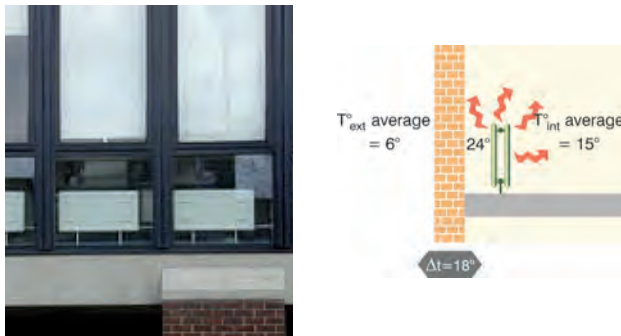

↑ Illustration 235 : Radiators in front of a non insulated wall (glazed or not).

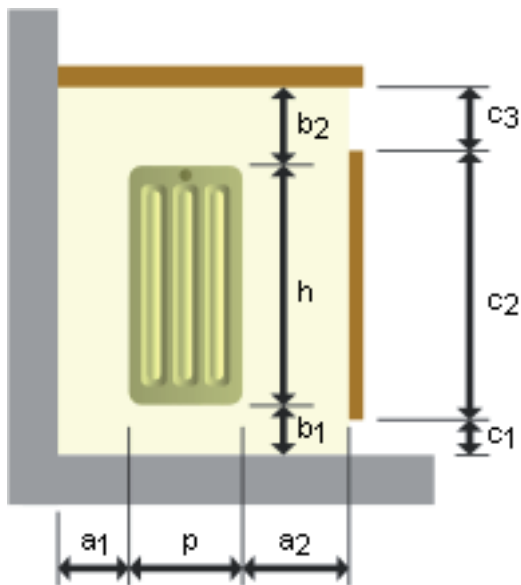

↑ Illustration 236 : Principle of a good radiator installation.

↓ Illustration 237 : Radiator in front of insulated wall.

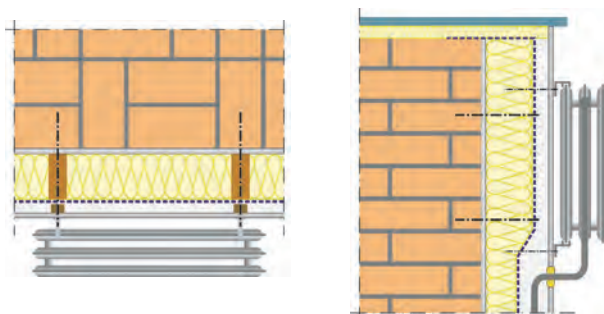

- a three speed circulator that will be set at the lowest nominal speed possible given the losses of pressure in the dwelling.

## 6. IMPROVING THE RADIATORS

Existing housing by and large uses radiators. These can be of several types:

- Panel radiators with reflectors or louvres
- Radiators with identical elements side by side in a sufficient number to obtain the necessary power.

In renovation, when the work has been done to reinforce the performance of the outer walls, the existing radiators are often too big, as compared to the needs. In this case, the water can be heated at a lower temperature, thus increasing the performance of the condensation boiler (gas or wood).

However, at the time the housing is renovated, certain measures can improve the effectiveness of the radiators:

### - Insulating the apron behind the radiators

Most of the time in existing dwellings, the radiators are installed in front of cold, uninsulated walls which results in significant losses (39 litres of fuel oil for 1 m<sup>2</sup> of a 24 cm brick wall).

Consequently, it is essential to:

- put insulation (2 to 3 cm) between the wall and the radiator, if the wall has not been insulated.
- move radiators that stand in front of glazing.

### - Uncover the radiator

All elements that cover the radiator (sills, decorative cabinets, drapes) are obstacles to the emission of heat. As such, this does not cause additional consumption, but may create discomfort. There is always an advantage in eliminating any obstacle present on the radiator.

The emission of a radiator will hardly be affected if the following dimensions of a niche are respected:

### - Balancing the installation

The heating installation should be correctly balanced, meaning that the various radiators should be supplied at their nominal flow. If not, the premises at the end of the circuit may have problems of comfort that will be compensated by increasing the settings and therefore causing overconsumption of energy.

## 7. INSTALLING OR IMPROVING THE REGULATION OF THE SYSTEM

In terms of energy performance and comfort, regulation is an essential element of a heating installation. Putting regulation on an unregulated heating installation (one that does not slow down at night, nor offer precise control of indoor temperature) can save about 30% of the annual cost of fuel.

Examples:

- 1°C higher room temperature, as compared to the recommended 20°C means overconsumption of at least 7%;
- the absence of intermittence in periods when the premises are not occupied results in overconsumption of 5 to 30% depending on the inertia and the level of insulation of the building.

# Optimizing the heating system

Quality regulation should:

- take account of the comfort perceived by the occupants;
- respect recommended temperatures, independently of any unforeseeable sources;
- stop providing heat when the premises are unoccupied;
- limit distribution and production losses;
- take account of rapid changes in the weather.

When renovating housing, two cases can exist:

- the existing installation has no regulation;
- the installation is regulated, but the regulation is not efficient.

**- Type of regulation in view of the size of the building and its functions**

The system of regulation varies with the type and the size of the building.

In individual homes, when a neutral locale can be found, regulation of production and distribution should be installed there, by means of a room thermostat.

In larger residential buildings or mixed buildings (housing and services), distribution can be dissociated into several circuits, each of which has its own regulation, generally depending on the outdoor temperature. This choice will depend on the differentiation in the times when the various premises are used (offices or services: during the day, residential: morning and evening).

In all cases:

- The premises should have a local thermostat to take account of additional, unscheduled heat (the most common are thermostatic valves)
- It should be possible to turn off the heat at different times in each unoccupied zone of the building by means of a clock.



↑ Illustration 238 : Radiator thermostatic valves.



↑ Illustrations 239 and 240 : Various types of regulator.

	Regulation of production	Regulation of distribution	Local regulation
Individual housing	room thermostats controlled by a clock:		thermostatic valves
Collective housing	temperature regulation, corresponding to the most demanding circuit	temperature regulation for each circuit (depending on the outdoor temperature). Acting on a mixing control valve and a clock. If possible, a thermostat to control intermittence	thermostatic valves

**- Type of regulation depending on the type of boiler**

Not all boilers can use any type of regulation: some require a minimum flow, others a continually high temperature. For this reason, the supplier should be asked to attest that the type of regulation chosen will not damage the boiler.

**- Compatibility of regulation systems**

If the regulation of production and/or distribution is handled by a room thermostat or thermometer, a radiator in those premises cannot be equipped with thermostatic valves. The competition between the two systems could mean that the boiler and/or circulator is kept in continual operation unnecessarily, with the consequent effects on energy consumption.

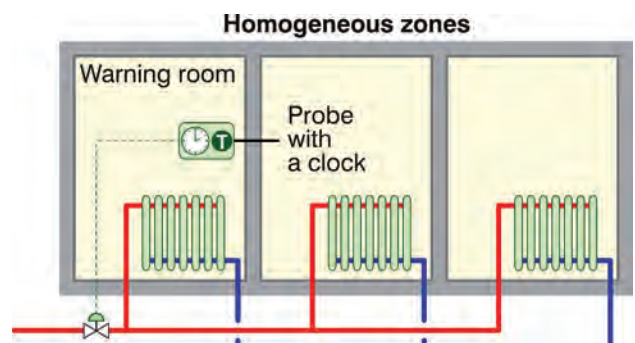

↑ Illustration 241 : Principle of regulation.

# Optimizing the heating system

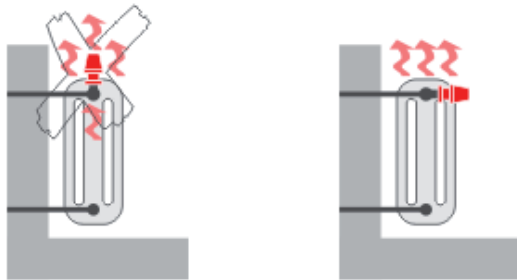

↑ Illustration 242 : Bad and good solution for valve placing.

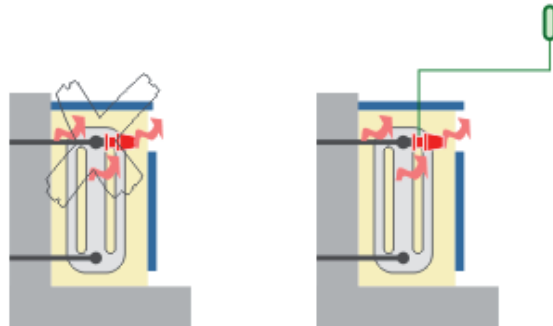

↑ Illustration 243 : Bad and good solution for radiator implementation.

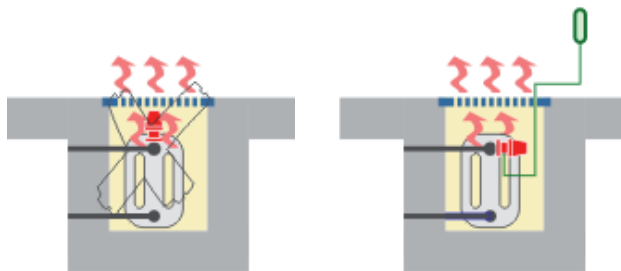

↑ Illustration 244 : Bad and good solution for radiator implementation.

### - Managing intermittence

Systems used to manage intermittence can be divided into two categories:

- Systems that decrease the temperature of the water;
- Systems that cut off the supply of hot water.

The second solution is preferable because the room temperature drops faster during periods of inoccupancy with an additional saving of energy that can be as high as 10%.

### - Keeping regulation simple

The trend in regulation is for sophisticated systems: everything is possible, but paradoxically, the equipment for setting the parameters is becoming increasingly difficult to understand and to use for an ordinary user.

But if the user, who is also the occupant of the building, does not understand or is not familiar with the operation of the equipment and the systems integrated in his dwelling, even the best regulation system can have disastrous results on energy consumption.

For this reason, on planning renovation, the designer should always install regulation equipment, corresponding to the occupants' and/or managers' aptitudes. Techniques should serve the occupant, not the other way around.

## 6. THE RIGHT SIZE TO MEET NEEDS

The size of the technical equipment has a significant impact on energy consumption in buildings. For example:

- Losses are greater in an oversized boiler when it shuts down, the operating cycles of the burner are shorter, causing greater emissions of pollutants (CO, NOx, soot, ...).
- An oversized circulator will consume more electricity and cause hydraulic problems in the installation (whistling in the valves, poorer efficiency in condensation boilers, ...).

The size of the equipment should be determined on the basis of an assessment of needs done as accurately as possible. Rough estimates or ratios are not enough for the final dimensioning of the equipment; a detailed calculation adapted to the project should always be done (by a technician if need be).

This calculation should be based on recognized standards in force and the contracting authority should require that designers and installers comply with them.

Oversized devices	Jugement	Impacts (comfort, consumption, pollution...)
Boiler	bad	Higher losses on shutting down Higher emissions of pollutants
Circulator	bad	Higher electricity consumption Loss of efficiency in condensation boilers Discomfort and poor operation of regulation
Air or water pipe	good	Lower consumption of circulators
Radiator	good	Increase in the efficiency of condensation boilers Increased comfort







## B.2. REDUCE FOSSIL ENERGIES CONSUMPTION

### Optimizing domestic hot water

N° of Sheet:  
**B21**  
 Cross-references:  
**B20, B22, B23, C01**  
 Appendix:  
 /



*In a residential building, energy consumption associated with producing hot water represents from 10 to 60% of the consumption of energy of the building, depending on the energy efficiency of that building (insulation, airtightness, ...). But the question of hot water is not limited to the consumption of energy needed for producing or distributing it. Rationalizing consumption of hot water also and above all means preserving reserves of drinking water.*

Picture from Architecture et Climat

#### 1. PRELIMINARY REMARK

On renovating housing, once the performance of the outside walls has been optimized and the need for heat has been reduced sharply, the need for hot water becomes proportionately more important.

In certain cases, in «passive» renovation, the need for heat for hot water represents as much as 70% of the total needs of the building.

Consequently, it deserves special attention, particularly since, unlike heating, hot water is consumed all year round.

The first energy saving for hot water is to limit consumption; this adds saving of drinking water to energy savings. Consumption of hot water will be reduced particularly by:

- the position of points of supply with regard to production;
- preventing leaks;
- the choice of appliances and points of supply.

Various aspects with a view to limiting consumption of drinking water are described in detail in information sheet C01.

↓ Illustrations 246 and 247: Hot sanitary water for baths and dishes



↑ Illustration 245: Tap water needs - Domestic consumption

#### 2. OBJECTIVES

The first objective is to produce hot water to meet the occupants' needs as efficiently as possible and with a minimum impact on the environment. To do this, the renovation should try to approach the following situation:

- choice of a central position for production
- limiting the distribution loops with maximum insulation
- using a source of renewable energy when this can be done
- choosing highly efficient production of heat
- limiting storage volume with maximum insulation

In the case of any «low energy» renovation, optimization of the system for hot water will depend significantly on the existing heating system.

# Optimizing domestic hot water

### 3. IMPROVING THE SYSTEM OF PRODUCTION

The various measures to be taken to improve the system for producing hot water are as follows:

#### 3.1. Centralizing/decentralizing the production of hot water

To limit losses on the distribution network, production should be put in a central position near the points of supply that will also be grouped.

##### - Individual housing

The wet rooms – kitchen, laundry and bathroom – will be grouped, one next to the other or one above the other, near production.

##### - Collective housing

In collective housing, certain points of supply will be at quite a distance from the central production. In this case, two solutions exist:

- the first solution tends to favor the comfort of the occupant: decentralized production of hot water by local production of hot water per apartment using gas flash heaters or electric accumulators;
- the second solution favours connecting the installation to other «renewable» systems such as the installation of solar panels, the installation of cogeneration and so on: with centralized production of hot water and insulation of the pipes to reduce losses.

The second solution should be given preference in terms of sustainable development, since, despite the loss of heat that is inherent to the distribution network given the length of the pipes, it can produce hot water using renewable energy sources.

#### 3.2. Configuration of the tank

The larger the hot water tank, the greater the losses through the sides of the tank. In renovation, the configuration of the tank should be improved by:

##### - Limiting the volume

Former installations are often too big as compared to needs. In renovation, one should check whether the volume of storage corresponds to the needs of the occupants and the dwelling.

##### - Reinforcing insulation of the sides

Today, it can no longer be maintained that saving energy for hot water can be limited to simply reducing the temperature of the water. To avoid proliferation of bacteria (*Legionella pneumophila*) in the network, it is recommended to maintain at least 60°C in the storage tanks. Correct insulation of the storage tank reduces losses and cold spots, where bacteria can survive (bottom of the tank).

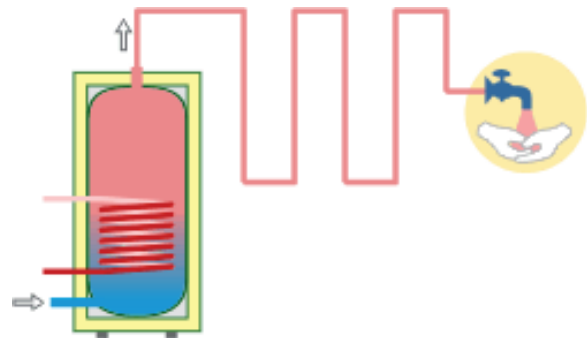

↑ Illustration 248 : Production and distribution network



↑ Illustration 249 : Insulation of the storage tank



↑ Illustration 250 : Insulation of the distribution network

## Optimizing domestic hot water

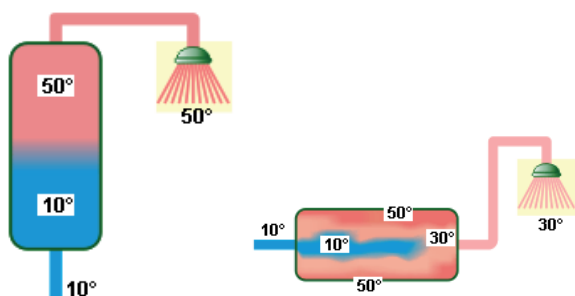

↑ Illustration 251: Influence of a good tank stratification

### - Improving the stratification of temperatures

In a vertical storage tank, an effort will be made to install stratification of temperatures so as to draw water as hot as possible from the top of the tank. This is harder to achieve in a horizontal tank, and there is really no solution for making improvements, except to insulate the pipes connected to the tank, preventing secondary thermal circulation and, consequently, cooling of the water in the tank.

### 3.3. Integrating a priority for hot water

When the production of heat and hot water are combined, there may be a conflict of temperatures: a high temperature is needed to produce hot water (60-70 °C) whereas water for heating in the summer (sliding temperature compared to the outdoor temperature: 43 °C on the annual average) could be 20 °C for example. To solve this problem, giving priority to hot water is a solution. In case of need, on the basis of a specific timetable, the boiler temperature will rise, and outside of these priority times, the temperature will fall again.

### 3.4. Pre-heating by a thermal solar panel

Annual energy consumption for the production of hot water can be reduced by 50 to 60% in individual homes and 20 to 40% in collective housing by putting in a thermal solar installation.

This alternative should be studied in priority on renovating housing because it saves fossil fuel as well as carbon dioxide emissions (from 150 to 400 kg of CO<sub>2</sub> per m<sup>2</sup> of panel).

Information sheet B23 goes into the details of this technique.



↑ Illustration 252: Renewables energies for hot water production

### 3.4. Pre-heating by heat pump

Hot water can be produced by means of a heat pump. Various technologies are possible. This «free» heat is extracted from a source (outdoor air, water table, ...) and is transferred to the hot water tank.

Information sheet B22 goes into the details of this technique.

## 4. IMPROVING DISTRIBUTION

The longer the distribution circuits, the greater the losses will be, and consequently the higher the operating costs. Various measures can be taken on renovation to improve the existing distribution of hot water:

### - Rationalizing the number of points of supply according to needs

Certain traditions or habits of «comfort» result in proliferation of the points of supply of hot water.

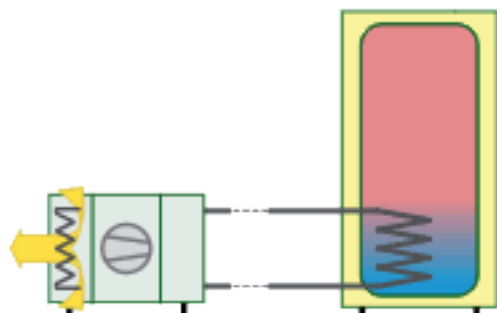

↑ Illustration 253 :

### Optimizing domestic hot water

---

Pertinence of these should be looked into. Certain uses of hot water are not necessary a priori: basin in the toilet, faucet for cleaning, ...

#### *- Limiting the length of the distribution pipes*

In order to limit the length of the pipes, the wet rooms requiring hot water (kitchen, bathroom, shower and laundry room) should be grouped near the source of production.

#### *- Insulating the distribution loop*

All of the distribution pipes should be insulated as effectively as the storage tank.

Optimal thicknesses of insulation range from 3 to 6 cm and depend on the diameter of the pipe, the temperature of the water (which depends on the type of regulation), and ambient temperature.

## 5. WHAT ABOUT THE OCCUPANTS' COMFORT ?

Comfort depends on several aspects:

- Stability of the desired temperature which depends on the quality of regulation of production;
- The waiting time, which depends on the distribution network and the location of the point of supply with regard to production;
- Not obtaining the temperature due to a lack of power when several faucets are supplied simultaneously from the same production.

In terms of comfort, partial or total storage is best suited to discontinuous demand. In fact, it acts as a buffer, eliminating the temperature fluctuations associated with the reaction time of production.

Conversely, flash heating systems can present fluctuations in temperature whether the flow of supply varies.

In terms of health, to prevent the risk of proliferation of bacteria (*Legionella pneumophila*), when one wants to lower the temperature to a lower regime (45°C), one solution could be providing peak temperature every week by increasing the temperature in the boiler to either:

- 60°C for 30 minutes
- 70°C for 4 minutes

In every case, the national rules on health have to be respected.



## B.2. REDUCE FOSSIL ENERGIES CONSUMPTION

### Heat pump as heating production

N° of Sheet:

**B22**

Cross-references:

**A21, B20**

Appendix:

/



Picture from Architecture et Climat

A heat pump becomes advantageous when the housing is renovated with the objective of approaching the «low energy» standard or even a passive standard. In this type of housing, the need for heat is not only low, but the temperature of hot water can also remain low (35°C); which suits a heat pump perfectly with very advantageous energy efficiency.

However, in renovation, and based on the principle that putting in a heat pump cannot be justified for high energy efficiency levels only, the choice of a cold source will be determinant in terms of investment costs.

#### 1. PRINCIPLE

A heat pump is a machine whose purpose is to take advantage of the free heat present in the environment: outside air, ground water, water tables, and the soil. In fact, any given body, even one that is «cold», contains an important quantity of energy that can be recovered.

The operating principle consists of extracting free heat from the outside milieu (called the cold source), increasing the level of the temperature and restituting the heat at a higher temperature in the dwelling.

A heat pump consists of a closed, airtight circuit in which a refrigerant fluid circulates in a liquid or gaseous state, depending on the components it goes through (evaporator, compressor, condenser, expander).

Following the operating diagram:

- the heat withdrawn (from the cold source) is transferred to the refrigerant fluid that vaporizes;
- the compressor sucks in the vaporized fluid;
- compression raises the temperature of the fluid;
- the fluid refrigerant transfers its heat to the water in the heating circuit or directly to the air of the premises to be heated;
- the fluid condenses then returns to liquid state;
- the expander reduces the pressure of the refrigerant liquid, triggering its vaporization.

The operation of a heat pump is more effective the smaller the difference in temperature between the cold source and the heat transmitters.

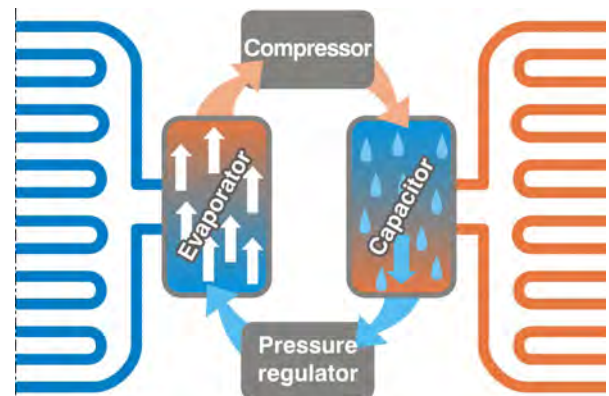

↑ Illustration 254 : Heat pump working principle.

*For the most part, refrigerants are harmful for the environment. Those that destroy the ozone layer are prohibited (particularly R22) and have been replaced by fluids like HFC. Nevertheless, these fluids are still powerful greenhouse gases. At the end of its service life, the heat pump must necessarily be disassembled by a specialist who recovers any refrigerant fluid to recycle it or destroy it.*

2. VARIOUS SYSTEMS

2.1. Different types of heat pumps

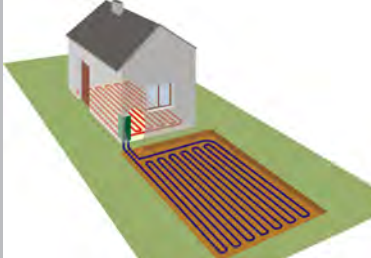
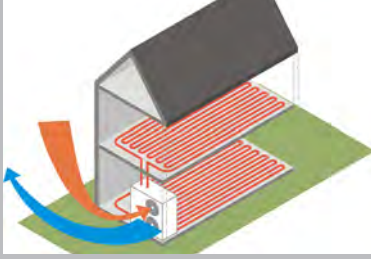
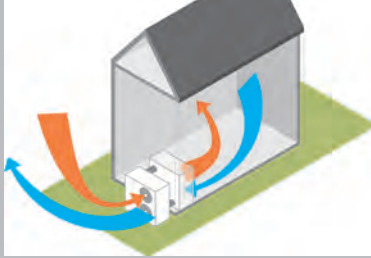
Type of heat pump	Schema	Cold source	Hot source
<b>Geothermal pump</b> Water/water heat pump		The cold source can be: <ul style="list-style-type: none"> <li>• the soil (geothermal coil or probe)</li> <li>• the water table</li> <li>• groundwater</li> </ul>	The hot sink consists of transmitters such as heat from the floor, convectors, a hot water battery on clean incoming air, ...
<b>Aerothermal pump</b> Air/water heat pump		The cold source is the outdoor air.	The hot sink consists of transmitters such as heat from the floor, convectors, a hot water battery on clean incoming air, ...
<b>Aerothermal pump</b> Air/air heat pump		The cold source can be the air extracted from the building.	The hot sink can be the air forced in.

2.2. Different types of circuits

**- Direct expansion heat pump**

This is a pump consisting of a single circuit. The fluid refrigerant circulates in a closed circuit in the pump, the collectors and the heat transmitters. This type of heat pump requires a lot of refrigerant fluid.

**- Mixed heat pump**

The heat pump consists of two circuits: one of a fluid refrigerant in the collectors at the heat pump, and a hot water circuit in the transmitters.

**- Intermediary fluid heat pump**

This heat pump consists of three circuits: the refrigerant circuit in the heat pump, the collector circuit, where water with antifreeze circulates, and the hot water circuit in the transmitters.

2.3. Operating modes

**- Monovalent heat pump**

The heat pump is the only system for producing heat.

**- Bivalent operating mode**

The heat pump is combined with another type of production of heat (a condensation boiler for instance).



↑ Illustration 255 : Heat pump Vitocal 350 by Viessmann - water/water.



↑ Illustration 256 : Heat pump Vitocal 100 by Viessmann - air/water

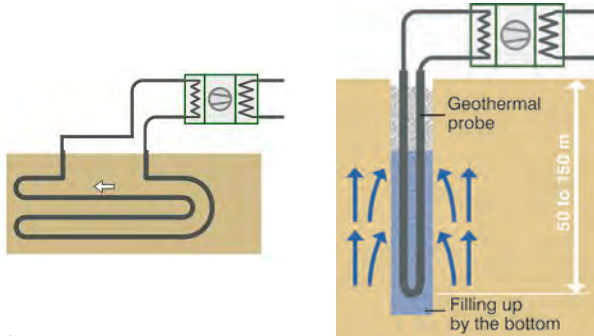

↑ Illustrations 257 and 258 : Horizontal (ground) and vertical (ground and water) collectors.

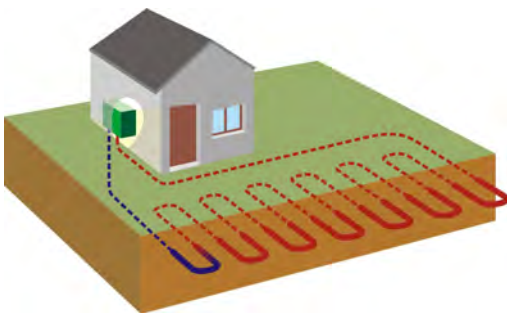

↑ Illustration 259 : Geothermic pump - horizontal collectors.



↑ Illustration 260 : Implementation of horizontal collectors.

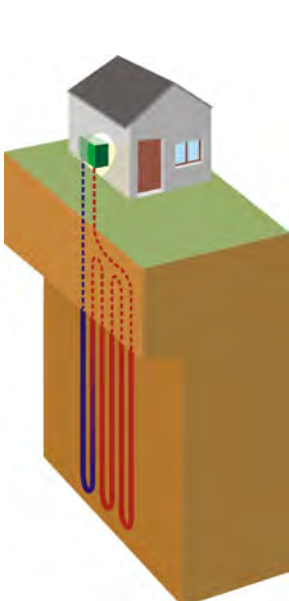

↑ Illustration 262 : Geothermic pump - vertical collectors.



↑ Illustration 261 : Implementation of geothermic pump - vertical collectors.

### 3. COLD SOURCE OR CALORIE COLLECTOR

The temperature of the cold source should be as high as possible. The temperature and the specific power of the cold source (and their stability over the year) will be contingent on:

- geographic location
- available space and accessibility
- the type of soil and subsoil

#### 3.1. Geothermal heat pumps

This type of pump draws calories from the earth or water in water tables, by means of collectors, probes or boreholes.

The earth, water tables, groundwater, rivers maintain the cold source at a relatively high temperature as compared to the air.

Nevertheless, the costs of studying and implementing this type of cold source are high.

In urban renovation, these costs may rise sharply because of the difficulty of gaining access to a garden or green area.

#### - Horizontal collectors in the ground

Horizontal collectors are polyethylene tubes or copper tubes coated with polyethylene. They are installed in a coil buried horizontally at a shallow depth (between 60 cm and 120 cm).

At this depth, the heat of the subsoil comes to a large extent from the sun's rays.

Water with antifreeze or a refrigerant fluid (depending on the technology used) circulates in a closed circuit in these coils. To prevent withdrawing too much heat from the soil and running the risk of freezing the soil and the loop, the coils must be placed with a minimum centre distance of 40 cm.

#### - Vertical collectors in the ground

Vertical collectors consist of two polyethylene tubes in a U-shape, installed in a borehole and sealed in it with cement. In most cases, several holes are drilled at least 10 m apart.

Water with antifreeze circulates in a closed circuit in these tubes.

The advantage of this system is to benefit from a source of heat that is more or less constant all year round.

The site area is small as compared to horizontal collectors, but doing the drilling requires a minimum of room and good accessibility. In addition, the implementation of the system is fairly costly.

#### - Vertical collectors in the water table

The water table as a cold source is advantageous because the temperature of the water is stable all year round and ideal for obtaining good results.

## B.2. REDUCE FOSSIL ENERGIES CONSUMPTION

### Heat pump as heating production

N° of Sheet:  
**B22**  
Cross-references:  
**A21, B20**  
Appendix:  
/

On the other hand, this system requires one or two boreholes that must be done by professionals with specific authorization. There are two systems: a system with a single hole in a system with two holes (see diagrams).

#### - Vertical collectors in groundwater

Groundwater as a cold source gives results that are less good because the temperatures fluctuate.

Two configurations are possible:

- direct utilization by immersing the evaporator in the river bed;
- indirect utilization via a heat exchanger absorbing the calories of a strainer well dug near the river.

Direct collection of calories in the riverbed is subject to considerable clogging of the evaporator, depends on the fluctuating flow of the river and is expensive to implement and maintain. Indirect collection, on the other hand, reduces the performance of the system.

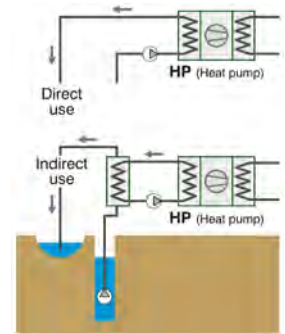

↑ Illustration 263 : Vertical collectors in water.

### 3.2. Aerothermal heat pumps

Aerothermal heat pumps recover calories in the ambient air (inside or outside the dwelling).

They are easy to set up and they adapt to many situations: individual homes, new or under renovation. Air is an easily exploitable source of heat – with no collector to be installed. On the other hand, outdoor air temperature varies considerably throughout the year, and as a consequence, performances of this kind of heat pump also vary. In addition, the system is larger, and noisier. This type of cold source could be envisaged in an urban setting (outdoor temperature slightly higher, reduce access to earth).

#### - Collecting the outdoor air

The heat pump is installed inside or outside the dwelling and collects heat from the outdoor air.

When the weather is cold, the evaporator in contact with the outdoor air may frost up, which reduces its effectiveness. This type of heat pump is consequently equipped with a regulation system that periodically reverses its operations for a short time to defrost the evaporator.

This type of heat pump can be reversible and provide fresh air to the dwelling in the summer.

#### - Collecting indoor air

This type of heat pump, also called a double effect thermodynamic pump, combines dual flow mechanical ventilation with a heat pump.

It ensures renewal of the air supply of the dwelling and it receives that supply: the heat pump recovers the heat in the air extracted from the wet rooms (kitchen, bathroom, toilet) and preheats the new air that is forced into the living premises.

This device is reversible, so it can provide fresh air to the dwelling during the summer.

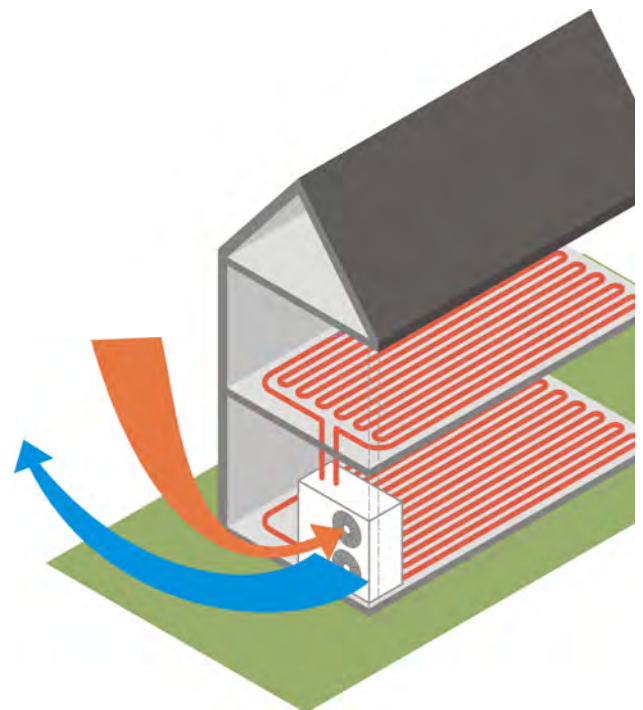

↑ Illustration 264 : Aerothermic pump air/water.

#### **Reversibility of the system:**

By reversing the cycle of the fluid refrigerant, the heat pump draws calories from the dwelling and transfers them outdoors. This scheme can provide a moderate drop in temperature, of about 3 to 4° as compared to the outdoors, so this is really a refreshing system rather than air conditioning. Installing a reversible system encourages consumption of electric energy all year long, for limited comfort in the summer, whereas a heat pump used exclusively for heating only consumes during cold weather.



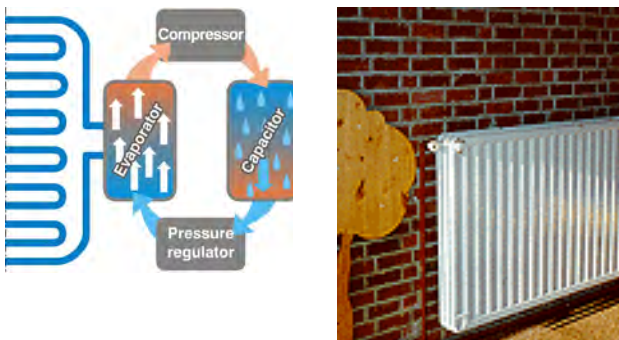

↑ Illustrations 265 and 266 : Hot sources : heating in the ground or radiators.



↑ Illustration 267 : Hot source : heating in the walls.

**4. HEAT SINK OR HEAT TRANSMITTER**

The temperature of the heat sink should be as low as possible to obtain optimal operation. This means that the transmitters should work at a low temperature. Heat pump systems are consequently systems that operate in very well insulated or passive dwellings, whether they are private homes or collective housing, where the transmitter is either an underfloor heating system or low temperature radiators (see information sheet B20).

In the case of renovation of housing where:

**- A heating system is already in the floor**

The transfer of the heat produced to the heat pump should pose no problem.

However, in a moderately insulated house, the inertia of the floor slab is often very high. Reinforcement of the envelope may be incompatible with this type of heating system. An alternative would be an under floor heating system with low inertia.

**- The transmitters are traditional radiators**

The decrease in the temperature transmitted (the operating temperature drops from 80/60°C to 35/45°C) will reduce the transmission power by about 60%. This power is theoretically sufficient when the envelope of the housing reaches good performance.

However, insulation of the envelope reducing losses to about 3 to 5 for very low energy to passive dwellings, should mean that this transmission is theoretically sufficient.

**- Putting in dual flow ventilation is planned**

The placement of an air-to-air heat pump will be considered where the cold source is the extracted air and the hot sink is the external new air.

**5. ENERGY PERFORMANCES**

Performances of heat pumps are expressed in coefficients that take account of their efficiency given the energy they consume.

**5.1. Coefficient of performance (COP)**

The coefficient of energy performance COP is the difference between the quantity of heat produced and the electric energy consumed. This shows the performance of a heat pump in the heating mode.

*Example:*

*If a heat pump consumes 1 kWh electricity and transmits 3 kWh of heat, its COP is 3.*

COP to reach according to the installation and the heat diffusion mode

Type of heat pump	Heating with pulsated air	Traditionnal radiators	low t° transmitters
Air/air heat pump	1.5 to 3		
Air/water heat pump	1.5 to 3	2 to 2.25	2.5 to 3
Water/water heat pump (horizontal)		2.5 to 3	2.5 to 3.5
Water/water heat pump (vertical)		2.5 to 3.5	3 to 4
Water/water heat pump (water table)		2.5 to 3.5	3 to 4

Source : *Se chauffer autrement*, Romain Claret et Jean-Michel Groult, Collection Habitat écologique, ULMER.

### 6. PRODUCING HOT WATER WITH A HEAT PUMP

A heat pump can also be used to produce hot water. This system can be independent or joined to the system for producing heat.

#### *- A production system independent of the system producing heat*

We do not recommend this system.

In fact, when a heat pump operates in a monovalent mode, it may lose all of its energy efficiency, since it must raise the temperatures of the heat sink up to about 60°C. In addition, most heat pumps saturate at about 55°. Consequently, it would need back-up, either electrical (tank with an electric coil and needle), or an efficient boiler.

#### *- A production system combined with the system for producing heat*

In this case, hot water is preheated up to the operating temperature of the heating system, which is about 35°C. Then an additional device (condensation boiler, electric or solar water heater) provides the rest to reach an operating temperature for hot water (about 55 to 60°C).

### 7. CHOOSING A HEAT PUMP IN THE CASE OF RENOVATION

In renovation, setting up a new geothermal heat pump in a dense urban area (downtown) is often impossible. In fact, using an underground coil at 1.5 m requires:

- doing groundwork on shared walls in the yard or demolishing and reconstructing them
- construction machines must have access to the yard
- additional costs

Generally speaking, heat pumps use a large quantity of electricity. Consequently it is important to have an installation with a COP above 3.

#### *- Individual housing*

On renovating an individual home approaching low energy or passive standards, a small heat pump (as from 9 kW for example) can be used. This type of heat pump exists in an air/water or a water/water version.

#### *- Collective housing*

There are several solutions for collective housing based on one or more heat pumps. Insofar as there is access to the ground, a water/water heat pump will be preferred, considering

- production of heat by one or several centralized heat pumps;
- production of heat by an individual heat pump.

The cold sources can be of different types, although for a large housing complex, the power that can be drawn from them will be limited. Today, a few large projects provide for the use of geothermal energy from a mine shaft, the water of a river or a lake... but the renewal capacity (or regeneration) of the cold source must be mastered.



↑ Illustration 268 : Installation of heat pump - Provelo renovation - Brussel.



↑ Illustration 269 : Installation of heat pump - Provelo renovation - Brussel.



## B.2. REDUCE FOSSIL ENERGIES CONSUMPTION

### Hot water production by solar energy

N° of Sheet:  
**B23**  
Cross-references:  
**B21, C01**  
Appendix:  
/

«The solar energy that reaches the entire surface of the earth is 10,000 times greater than the total energy demand of the earth's population. The solar resource is by far larger - and more sustainable - than all identified reserves of fossil and nuclear energy.»

Source: *Installations solaires thermiques, Editions Le Moniteur*

For a given economic optimum, the annual consumption of energy for heat and hot water can be reduced by 50 to 60% for individual homes and 20 to 40% for collective housing by using a thermal solar installation. Moreover, this type of installation can significantly reduce CO<sub>2</sub> emissions (between 150 and 400 kg of CO<sub>2</sub> per m<sup>2</sup> per collector and per year).

#### 1. PRINCIPLE

Under the action of the sun's rays, a fluid circulating in the solar collector heats up. Insulated pipes carry the hot fluid to the lower exchanger of a hot water tank where the heat is transmitted to water used in the dwelling. When there is no sunshine, traditional production using a boiler or electric coils acts as back-up. From the environmental standpoint, of course the electric option is not recommended.

There are two major categories of solar installations:

- Installations using water with glycol;
- Installation with a drain back system (without glycol).

Overall efficiency between the two systems stays about the same, due to important increase of electricity consumption for pumping.

↓ *Illustration 270 : Installation principle.*

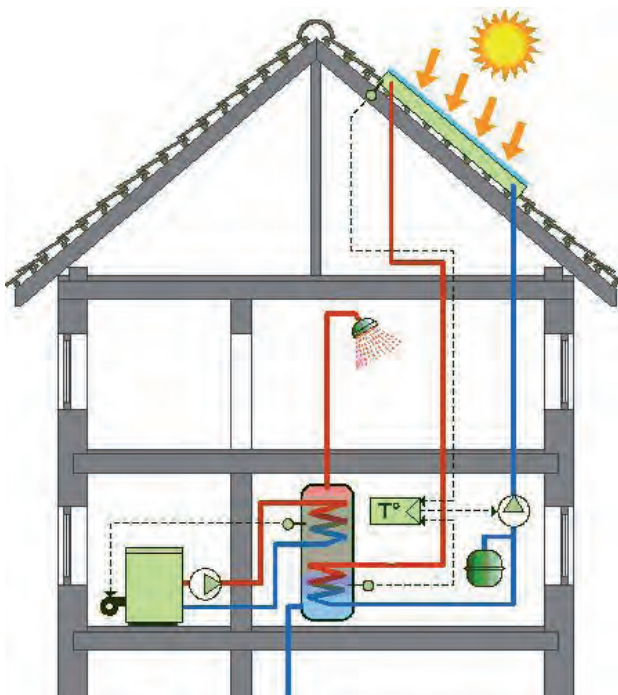

The major elements of a thermal solar installation are:

- The solar collectors themselves
- The distribution circuit
- The hot water tank with a double coil
- The regulator



↑ *Illustration 271 : Plane collectors.*

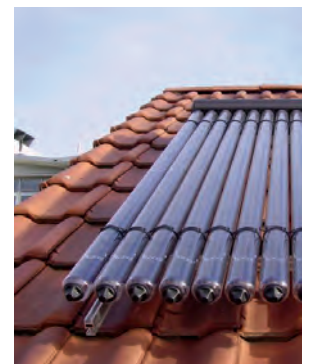

↑ *Illustration 272 : Vacuum collectors.*

**2. DESCRIPTION OF THE SYSTEM**

**2.1. The collectors**

There are several types of collectors. The main ones are:

- collector panels, the best-known and the most used
- vacuum collectors

Vacuum collectors are more efficient than panels, particularly in the winter.

Because of the vacuum around the absorber, a vacuum collector will be less influenced by the outdoor temperature.

On the other hand, this type of collector is more expensive.

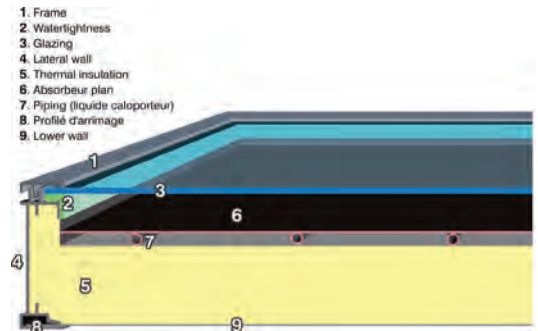

↑ Illustration 273 : Plane collector - principle diagram.

**2.2. The storage tank**

Storing the energy can compensate for the discontinuous supply of solar energy.

In renovation, there are two possibilities for putting in a solar heating system:

- Maintaining the current installation for hot water and putting in a tank upstream of the existing tank (tank with a single electric resistance or coil combined with the boiler);
- Replacing the existing tank by a tank with a double coil. The upper coil is connected to the existing boiler and the lower one is supplied by the solar installation.

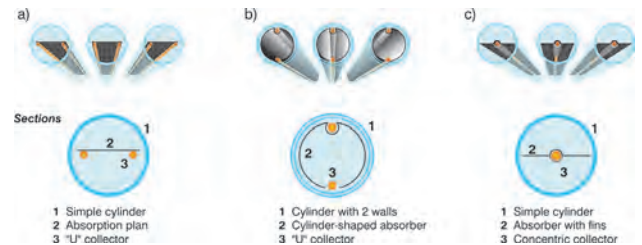

↑ Illustration 274 : Vacuum collectors

**- Thermal stratification of the tank**

It is important to respect thermal stratification in the storage tank. For this reason, the tank should be placed vertically, and be as narrow and as high as possible (the ratio of height to diameter being 2 to 2.5).

Because of the stratification of the tank, hot water rises to the upper part of the tank, because it has lower density than cold water. When hot water is drawn, it is replaced by cold water from the bottom of the tank. Consequently there is a superposition of layers of water at different temperatures.

**2.3. The distribution circuit**

**- The pipes in the circuit**

The distribution circuit links the collector or collectors to the storage tank.

Copper or steel tubes are used for these pipes.

The pipes must be correctly insulated to limit loss of heat between the collectors and the storage tank.

**- The heat conducting fluid and the expansion tank**

The heat conducting fluid is used to supply the storage tank with heat. Several fluids can be used (water, glycol, ...) but care must be taken to avoid freezing of the installation. A fluid that resists temperatures of 20°C will preferably be used in temperate to cold regions.

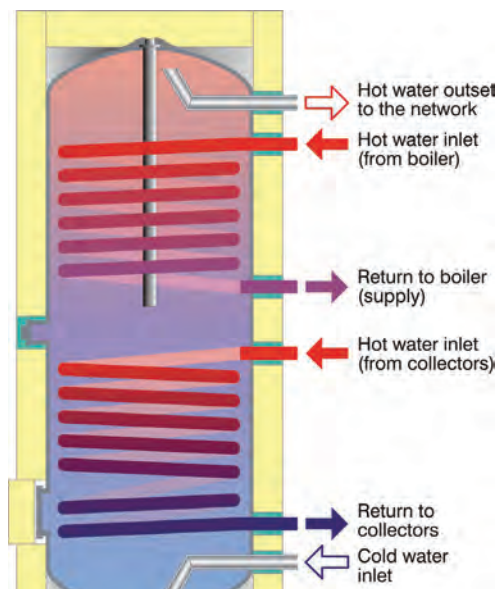

↑ Illustration 275 : Installation of storage tank.

An expansion tank allows for the expansion of the heat conducting fluid and absorbs the increase in volume without too much of a rise in pressure if boiling should occur.

**Remark :**  
*In case of a new tank upstream of the existing tank, various solutions exist to prevent the risk of proliferation of bacteria:*

- **pump for «de-stratification»:** for regularly bring the water in the two balloons to a sufficient temperature;
- **«dead» water tank:** the risk of contamination will be avoided by physically separating the waters of different temperatures

### **2.4. The solar installation**

In most thermal solar installations, there is a «solar station» module including the circulator, the valves and the check valves. Regulation is generally integrated in the module.

#### **- The circulator**

The role of the circulator is to ensure circulation of the heat conducting fluid in the distribution circuit.

The circulator is controlled in view of the difference in temperature between the fluid in the collectors and the water in the storage tank.

A positive differential of about 5°C triggers the system and heats the water in the storage tank. Conversely, a differential of 2°C stops heating the water in the tank.

#### **- The various valves**

A number of valves are needed for the proper operation of the installation such as the safety valve to limit pressure, the drain valve, and the air eliminating valve.

#### **- The regulation**

The regulator has various functions such as:

- optimizing the heat in the storage tank for the solar radiation on the collectors
- protecting the installation from overheating of the collectors

### **2.5. Back-up**

Putting in a thermal solar installation does not necessarily mean replacing the existing heating system. In fact, the existing installation becomes the back-up of the solar system.

In the case of :

#### **- An existing boiler for heating**

The storage tank can be maintained, downstream of the solar tank.

However, if the existing tank has reached the end of its service life, it can be advantageously replaced by a double coil solar tank (the coil at the top of the tank is connected to the existing boiler, and the coil at the bottom to the solar installation).

#### **- An existing flash water heater**

Putting the solar tank upstream works correctly.

#### **- An existing electric water tank**

Although this is not an ideal solution (relative inefficiency of electric power plants, high price of electricity), putting a solar tank upstream can be considered.

## **3. ELEMENTS INFLUENCING THE CHOICE**

The elements to be taken into account on designing a hot water installation are as follows:

- geographic location;
- orientation and slope of the collector;
- the type of collector.

### 3.1. Geographic location

Sunshine differs depending where one is in Europe. This means that to provide hot water, the area of the thermal collectors will have to be greater or smaller mainly in view of the latitude.

### 3.2. Orientation and slope

In renovation, the choice of orientation is limited, nevertheless, the collectors should be oriented between southeast and southwest and sloped at 25 to 60° from a horizontal axis. Orientation focusing to the east or west reduces efficiency by about 20%. Finally, the risk of shadows (chimneys, nearby trees etc.) should be taken into account.

For collective housing, it might be worth looking into systems that «follow the sun» from east to west, although the additional cost of this kind of system can be integrated into large projects only.

### 3.3. The type of collector

Depending on the desired application, a solar panel or a vacuum tube collector will be chosen.

In renovation:

When the areas envisaged for placing the collectors are small and orientation is poor for energy efficiency of the solar installation, then collector tubes could be used. This type of collector can be chosen when the solar installation is to be combined with the heating system.

## 4. DIMENSIONS AND IMPLEMENTATION

The quality of a thermal solar installation depends on the quality of the collectors as well as the dimensioning of the installation.

### 4.1. Hot water consumption

Hot water consumption varies considerably depending on the life style of the occupant.

Daily water consumption can vary from about 30 litres to more than 400 depending on geographic location and the consumers' life style.

To determine the demand for hot water, the following parameters must be known:

- consumption of the dwellings in litres per day
- temperature of the cold water in the public distribution network (+/- 10°C);
- minimum hot water temperature (+/- 45°C) ;
- rate of solar cover needed or required

### 4.2. Area of the collector

The solar fraction (f<sub>sol</sub>) or the rate of solar cover represents the share of hot water produced by solar energy on the average over the year, after deducting losses.

The larger the collector surface, the greater the solar cover.

A solar fraction of 30%, generally close to the economic optimum, takes about 1 m<sup>2</sup> of collector for 80 litres of hot water at 60°C.

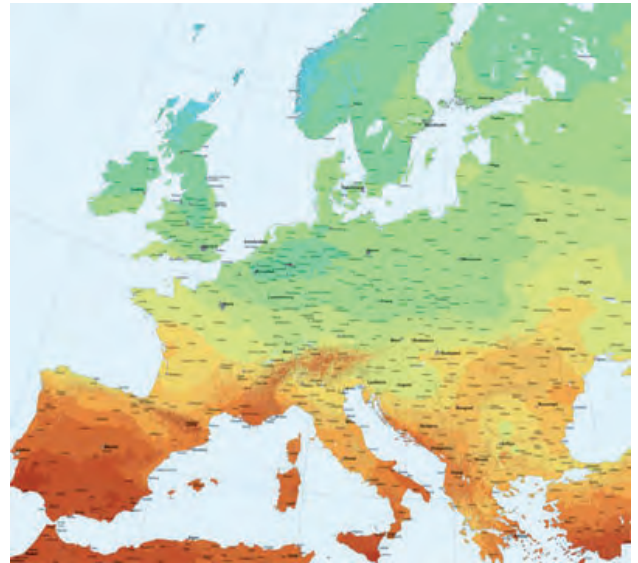

↑ Illustration 276 : Geographical localization.

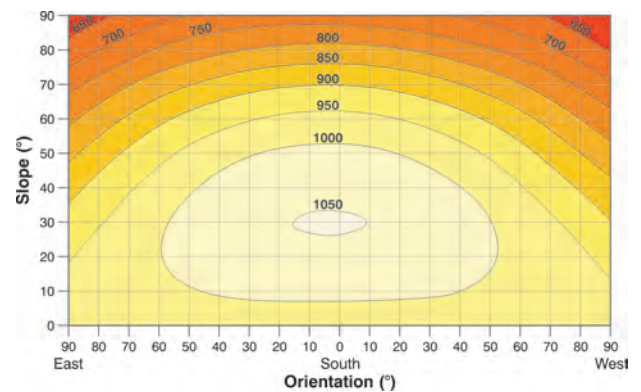

↑ Illustration 277 : Influence of the slope and orientation on the efficiency.

## B.2. REDUCE FOSSIL ENERGIES CONSUMPTION

### Hot water production by solar energy

N° of Sheet:  
**B23**  
 Cross-references:  
**B21, C01**  
 Appendix:  
 /



↑ Illustration 278 : Plane collectors in superposition of roof.

↓ Illustration 279 : Vacuum collectors.



#### 4.3. Dimensioning the tank

The tanks are chosen in view of the volume of water used and the maximum temperature required.

A temperature of 45°C is usually sufficient for bathing, whereas maintenance needs a temperature of 50 to 60°C.

The tanks are designed to deliver maximum temperatures of 80 to 90°C.

Generally speaking, and depending on the geographic location, the size of the solar tank is planned for 50 to 80 litres per m<sup>2</sup> of collector area and 1.3 to 1.7 times the daily consumption of hot water (30 to 60 l per day and per person on the average).

#### 4.4. Where to put the solar collectors

The solar collectors can be installed in several ways. The most suitable will be chosen, given the type or renovation done in the existing dwelling:

##### - Mounted over the roof when the roof cover is maintained

The legs are fastened directly on the frame of the roof; the panel frame and then the collectors are placed on these.

The advantage of this type of assembly is that it does not affect water tightness of the roof.

##### - Integrated in the roof when the roof covering is replaced

The collectors are placed directly on the frame and replace the existing roof cover.

##### - Mounted on a terrace or flat roof

Aluminum sections can tilt the collectors at 45°. These sections are fastened on to the roof or weighted down with concrete blocks.

A revolving system can be mounted in this way to follow the course of the sun from east to west (in large collective housing complexes).

#### Installation example in Belgium with a technical and economical optimum:

Number of occupants	Surface of collectors	Storage volume	Produced energy solar fraction of 55%	Energy saving supply system with an annual output of 75%
2 to 3 persons	+/- 4m <sup>2</sup>	+/- 200l	+/- 1200 kWh/year	+/- 1600 kWh/year
4 to 5 persons	+/- 5m <sup>2</sup>	+/- 300l	+/- 1600 kWh/year	+/- 2200 kWh/year
6 to 7 persons	+/- 7m <sup>2</sup>	+/- 400l	+/- 2300 kWh/year	+/- 3100 kWh/year

Source : Guide pratique pour la construction et rénovation durables de petits bâtiments, IBGE, Bruxelles, 2007.







## E. REDUCE FOSSIL ENERGIES CONSUMPTION

# Optimizing the lighting system

N° of Sheet:  
**B24**  
 Cross-references:  
**B11, B18, B25**  
 Appendix:  
 /



Since the appearance of the incandescent lamp designed by Edison, artificial lighting has developed in all sectors: lighting of roads, housing and offices, decorative lighting, etc. One of the advantages of artificial lighting is that it is continually available as long as there is an energy supply. Whatever the hour of the day or night, various activities can be lit: working at a desk, preparing meals, ... Unfortunately, artificial lighting also has the disadvantage of consuming more or less electric energy, entailing nuisances, pollutions and exhaustion of resources.

In terms of sustainable development, natural lighting should be preferred (see information sheet B09) with efficient, energy-saving artificial lighting.

Picture from [www.energieplus-lesite.be](http://www.energieplus-lesite.be)

### 1. PRELIMINARY REMARK

This entire information sheet has been drafted based on the Guide Pratique et technique à l'éclairage des logements by B.Roisin, M.Bodart, A.Deneyer (Architecture and Climate), 2009, as part of the Minergibat-Eclos contract.

### 2. BASIS NOTIONS

Before presenting solutions for effective lighting in the housing to be renovated, a few basic principles of light and lighting should be explained.

#### - Lighting

Lighting is the quantity of luminous flux (light) received by a surface. It is measured in lux:  $1 \text{ lx} = 1 \text{ lm/m}^2$

Examples:

- Surface de travail dans un bureau : de 300 à 1000lx
- Sol extérieur par ciel couvert : de 5000 à 20000lx
- Sol extérieur par ciel clair : de 7000 à 24000lx
- Surface perpendiculaire au soleil d'été : 100000lx

#### - Brightness

Brightness is the only real quantity perceived by the human eye. It corresponds to the visual sensation created by a source of light or a lit surface.

Examples:

- Landscape by night :  $10^{-3} \text{ cd/m}^2$
- Landscape by full moon :  $10^{-2}$  à  $10^{-1} \text{ cd/m}^2$
- Landscape by overcast : 300 à 5000  $\text{cd/m}^2$
- Moon : 2500  $\text{cd/m}^2$
- White paper : environ 25000  $\text{cd/m}^2$
- Sun : 1,5.109  $\text{cd/m}^2$

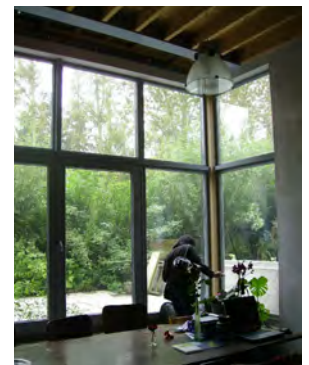
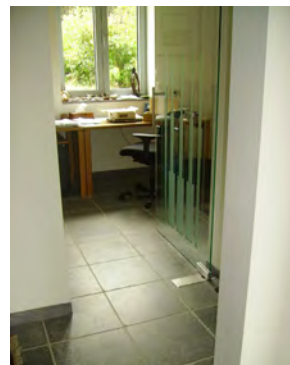

↑ Illustration 280 and 281 : Quality of natural lighting



↑ Illustration 282 : Lighting definition

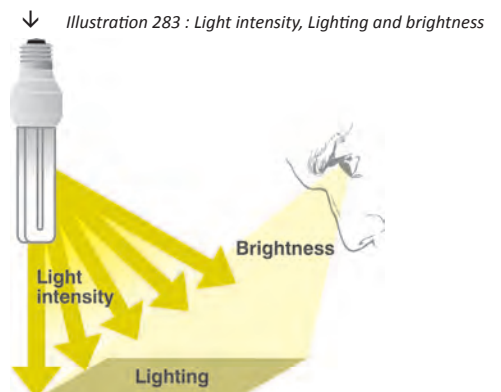

↓ Illustration 283 : Light intensity, Lighting and brightness

### 3. WHAT DOES A LIGHTING FIXTURE CONSIST OF?

A lighting fixture is made up of several separate parts:

#### 3.1. The light source

The light source or lamp is the basis of a lighting fixture. Its role is to provide the light needed to light up an area, a room, a table, ...

There are three main categories of light sources, referring to the means used to provide the light:

- incandescence
- discharge
- light emitting diodes (LEDs)

↑ *Illustration 284 :*

#### 3.2. The auxiliaries

Some lamps need auxiliaries to function correctly. These can be broken down into two main categories:

- The **transformer** used in very low voltage halogens. Its role is to supply the lamp with lower voltage (generally 12V for a halogen) than the voltage drawn from the grid;
- The **starter and the ballast** are used for discharge lamps. The fundamental roles of these is to light the lamp and to limit the current in the tube while it is in use, and to prevent it from being destroyed.

↑ *Illustration 285 :*

#### 3.3. The luminaire

The third element in a lighting fixture is the luminaire. This contains the lamp itself as well as any auxiliaries. It can have a triple role:

- The luminaire serves to direct the supply of light to the area to be lit;
- It serves in certain cases to protect the lamp and any auxiliaries from outside influences (contact, water, dust, etc.) ;
- it has an esthetic role, due to its shape, colour, materials and the way it directs light in the room.

### 4. CHARACTERISTICS AND TYPES OF LAMPS

In residential housing, the choice of a lighting system is based by and large on subjective esthetic criteria, whereas in the service sector the main criteria are functional, economic, and sometimes environmental. This section presents various types of lamps that can be found in residential buildings, with the advantages and disadvantages of each.

#### 4.1. Characteristics of the lamps

Certain parameters determine the quality and characteristics of lamps. They include:

##### - *The luminous flow and output*

The luminous flux is a source defined by the quantity of light radiated by a source in all directions. It is expressed in lumen (lm).

This is the «lighting power» so to speak that a source emits.

↓ *Illustration 286 : Luminous flow of a lamp*



# Optimizing the lighting system

N° of Sheet:  
**B24**  
 Cross-references:  
**B11, B18, B25**  
 Appendix:  
 /



↑ Illustration 287 : Luminous intensity



↑ Illustration 288 : Color temperature of light

The light efficacy can be derived from the luminous flux by dividing the luminous flux by the electric power of the source. Consequently, the unit is  $\text{lm/W}$ .

*Example:*  
 A standard 60W incandescent light bulb has a luminous flux of about 700 lm. Its luminous efficacy is therefore 11,7  $\text{lm/W}$ .

**- The luminous intensity**

Luminous intensity is the luminous flux emitted in a single direction. This is expressed in candela (cd).

**- The colour temperature**

The colour temperature of a lamp mainly describes the colour and light ambience given by the lamp. This is expressed in Kelvin (K).

One refers to cool colours when the colour temperature is high (greater than 5000 K) and warm colours when the colour temperature is lower than 3300 K.

*Example:*  
 A traditional incandescent lightbulb has a colour temperature of 2700 K.

A halogen lamp has a colour temperature of 3000 K.

**- Colour rendering Index**

The colour rendering Index (Ra) describes the way a source restitutes the various wavelengths of the entire visible spectrum, or in other words how accurately the colours of an object are «rendered» in comparison with those colours under natural light. The colour rendering index is given on a scale ranging from 0 (mediocre) to 100 (perfect).

*Example:*  
 Daylight has a Ra of 100  
 An incandescent lamp (traditional and halogen) has a Ra of 100  
 A fluorescent lamp has a Ra ranging from 60 to 90

**- The lifespan**

There are several definitions of the life span of a lamp. Generally speaking, the reference uses the average life span of a batch of lamps, that being the number of hours of operation of all those lamps before 50% of them are no longer operable.

The concept of non-operable can differ from one region of the world to another.  
 In Europe, a lamp is considered non-operable when it emits only 70% (85% for incandescent bulbs) of its initial luminous flux. In the United States, a lamp is considered as non-operable when it no longer works.

↓ Illustration 289 : Energy efficiency



## Optimizing the lighting system

## 4.2. Description of various lamps

Type of lamps	Working	Available capacity	Efficiency and energy category	T° of color and color render	Lifespan
<b>Traditional incandescent lamps</b>	To produce light, a tungsten filament is heated by the passage of electricity. The filament is enclosed in a vacuum or gas filled globe.	from 25 W to 100 W Luminous flux varies from 200 to more than 1900 lm	Low efficacy, between 5 and 19 lm/W The energy class varies from E to G	Warm white colour (2700 K). Excellent colour rendering (Ra=100).	Relatively short: 1000 h
<b>Incandescent halogen lamps (spot lights, capsule lamps, mini tubes)</b>	The operation is practically identical to that of traditional incandescent lamps. The only difference lies in adding a halogen gas in the lamp with the effect of increasing the life span and preventing the lamp from darkening and thus losing luminous flux.	from 5 W to 500 W The luminous flux varies from 50 to more than 10 000 lm	Efficacy varies from 10-12 lm/W for a standard halogen lamp to practically 30 lm/W for IRC lamps. The energy class ranges G to B.	The colour of halogen lamps is 3000 K, a neutral white. Excellent colour rendering (Ra=100).	2000 to 5000 h Low voltage (12V) halogen lamps have a longer life than their equivalent in 230V.
<b>Fluorescent tubes (T8 Tubes; T5 Tubes must be used with electronic ballast; Circular tubes)</b>	Fluorescent tubes use the principle of electric discharge and a gas to create light. To operate the tube, a ballast and a starter must be used to limit, control and trigger the discharge.	Between 14 and 58 W. The length of the tubes varies with the capacity.  The luminous flux of the tubes ranges from 1300 to 5000 lm	Very good luminous efficacy. It ranges from 60 to 105 lm/W. Energy class is generally A.	The colour temperature varies with the power used in the tube from hot white (2700 K) to cold white (6700 K). The colour rendering index is not perfect, but still fairly good (Ra from 80 to 95).	The life span of a fluorescent tube depends in part on the type of ballast and the type of starter; it can be as much as 20,000 h.
<b>Compact fluorescent lamps – CFLs</b>	Compact fluorescent lamps are in fact miniature curved fluorescent tubes, whose dimensions have been reduced to use them as a substitute for incandescent lamps.	The capacity range is very broad: from 3 to 23 W for lamps with integrated ballast and from 5 to more than 80 W for lamps with external ballast. The luminous flux ranges from 100 to more than 6000 lm.	Good luminous efficacy ranging from 35 to 80 lm/W. The energy class is generally A and in certain cases B.	The colour can range from hot white (2700 K) to cold white (6500 K). The colour rendering index is good, between 80 and 90.	The duration of compact fluorescent lamps with integrated ballast is about eight times longer than incandescent lamps (from 6000 to 10,000 hours).
<b>Les LEDs (Light Emitting Diode)</b>	Light is created by LEDs using a third principle. A LED is in fact a semiconductor composed of a junction of two materials, one of which has excess electrons and the other a shortage. When this junction is submitted to a voltage differential, the excess electrons go into the shortage zone and recombine. This recombination provides radiation, whose colour depends on the elements.	Available capacities on the market range from 0.007 W to 3 W. The luminous flux ranges from 1.5 lm to 200 lm. It is also true that the luminous flux varies significantly with the ambient temperature.	LEDs available on the market have efficacy of 20 to 30 lm/W (white light). The energy class ranges from D to B.	The colour temperature of LEDs ranges from hot (2700 K) to cold (6500 K), but rendering is better at cold temperatures. The colour rendering ranges from 50 to 80.	The life span of LEDs can be highly variable depending on the ambient temperature and the voltage applied. It can range from 5000 hours to more than 100,000 hours.

**5. CHARACTERISTICS AND TYPES OF LUMINAIRES**

**5.1. Characteristics of luminaires**

**- The output**

A luminaire, by its very function, is an obstacle to the distribution of light, because it cannot totally reconstitute the light supplied by the luminous source, as part of the rays are absorbed by the components of the luminaire.

The output of a luminaire is a ratio of the luminous flux emitted by the luminaire as compared to the luminous flux of the lamp.

**- The luminous distribution**

There are three main types of distribution:

- Extensive where the ray of light is broad and gives relatively uniform lighting;
- Intensive with a narrow ray of light for lighting emphasis;
- Asymmetrical that can be used to light vertical surfaces like walls or paintings.

**5.2. Lighting system**

Depending on the luminaires used and where they are placed, various lighting systems exist:

**- Direct lighting**

The light is emitted directly on the surface to be lit. Efficacy of this type of lighting is very good, so the power installed will be low.

Conversely, there is a higher risk of glare using this system and the distribution of light in the premises may be fairly irregular.

**- Indirect lighting**

Indirect lighting consists of using a reflecting surface (often the ceiling) to diffuse light in the premises. The advantage of this system lies in its relatively small risk of glare and good distribution of the light in the premises.

The efficacy of this system is lower than for a direct system and can even be mediocre in dark areas.

**- Mixing lighting**

For this lighting system, the two previous systems are combined with their advantages and disadvantages.

**- Lighting with two components**

In this system, two luminaires are used: the first gives general lighting and the second adds back-up lighting where necessary.

**5.3. Description of various luminaires**

**- Ceiling mounted luminaire**

Ceiling-mounted luminaires are commonly used to light dwellings.

Often the lamps are enclosed in frosted glass that distributes the light fairly broadly in the premises. They can be used mainly for the general lighting of all rooms.

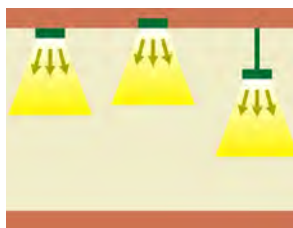

↑ Illustration 290 : Direct lighting

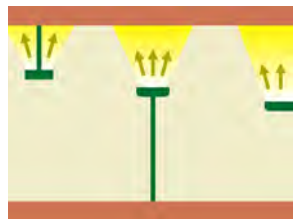

↑ Illustration 291 : Indirect lighting

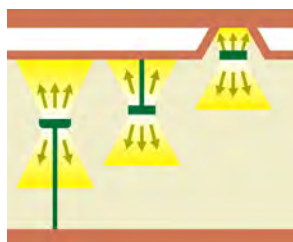
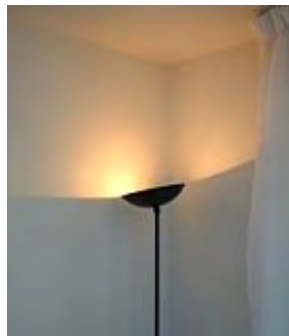

↑ Illustration 292 : Mixing lighting (direct and indirect)

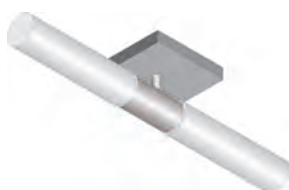

↑ Illustration 293 : Ceiling light

## Optimizing the lighting system

N° of Sheet:  
**B24**  
 Cross-references:  
**B11, B18, B26**  
 Appendix:  
 /

### - Chandelier or hanging luminaire

Chandeliers and hanging luminaires generally play two roles in residential lighting. Although some hanging luminaires can provide lighting focusing on a zone, by and large they provide general lighting of the entire room. In addition, they are often an integral part of the decoration of the premises.

### - Wall-mounted light

A wall-mounted light is an integral part of the decoration of the room. It is used mainly to add a certain ambience to the general lighting of the room. It is also often used for specific applications of light such as highlighting mirrors etc.

### - The spotlight

Spotlights are generally built into the ceiling. There are also spotlights on rails that can easily add flexibility to the lighting system (possibility of adding or removing spotlights, displacing them, orienting them etc.). These are often used to accentuate lighting in combination with other luminaires. Sometimes they are used on their own, although in that case, they create major contrasts in the premises they light.

### - The linear light strip

A linear light strip is a simple and popular luminaire. The again, because of its very limited esthetic presentation it is only used for specific applications. It may be hidden behind architectural elements (wooden siding, curtain holders etc.) or by the furniture (position on the top of cupboards, etc.). It generally provides indirect lighting (by reflecting off the ceiling).

### - Freestanding luminaires and back-up lamps

Freestanding lamps and back-up lamps provide good lighting when the general lighting of the room is not sufficient. Desk lamps and reading lamps fall into this category. Freestanding luminaires that can be found in homes are generally indirect halogen candelabras. These are highly appreciated for their indirect lighting and their adjustability. On the other hand, the lamps in these luminaires are generally very powerful (300 or 500 W) resulting in a high consumption and operating cost.

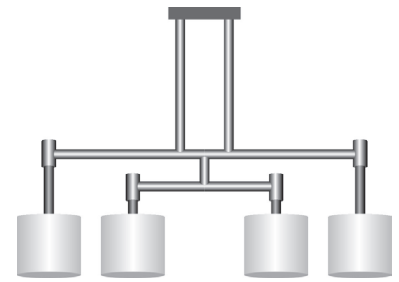

↑ Illustration 294 : Suspended luminaire



↑ Illustration 295 : Wall light



↑ Illustration 296 : Spotlight

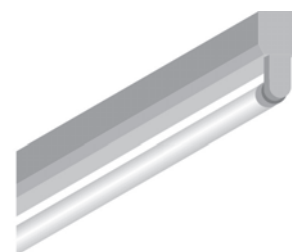

↑ Illustration 297 : linear light strip



↑ Illustration 298 : Luminaire on foot

## 6. LIGHTING MANAGEMENT

### 6.1. Principles of action

#### - *The switching on/off*

Switching on and off is the easiest way to control lamps. The electric circuit does or does not power the lamp as needs require.

#### - *Adjusting the intensity*

This consists of controlling the luminous flux of the lamp in keeping with the users' needs. This is easy to do for incandescent lamps – reducing the voltage of the power supply will reduce the luminous flux.

#### - *Time control*

Time control uses a clock to produce actions on the lamps. The actions can be carried out at a pre-programmed time, or a certain amount of time after the lamps have been lit or adjusted.

#### - *Movement detection lamps*

Movement detection lamps use a sensor that detects the presence (or absence) of movement in a specific zone. Two types of technology are used: PIR (Passive InfraRed) detectors and HF (High Frequency) detectors. PIR detectors operate by detecting a warm, moving body, whereas the HF detector uses the Doppler effect (reflection of various waves on a moving body) rather like a sonar.

These lamps can act in three ways: coming on, switching off or in certain more rare cases, adjusting the intensity. In addition, some of them operate totally automatically (they switch on when they detect a presence and switch off, if not). Others, which are less standard but preferable, must be switched on manually and switch off automatically when they no longer detect movement. These are often called «absence detectors».

### 6.2. Controlling tools

#### - *Light switch*

A light switch is the simplest tool for controlling lighting. This is generally an appliance that will open or close the electric circuit mechanically and therefore provide or cut off the power supply to the lamps.

#### - *The dimmer*

The dimmer is a tool for control which allows, to modify the flow of the lamps which it controls. In general, those functions only for the incandescent lamps (including the halogen).

#### - *The time switch (timer)*

A time switch is a device that is generally mounted in the fuse box. It automatically stops the lighting after a certain amount of time that can be set by the user. This type of management is very practical in circulation zones (halls, stairways etc.) where presence is temporary.

#### - *The detector of presence*

There are different types of presence detectors: wall-mounted and ceiling-mounted. The advantage of wall-mounted detectors is that it is easy to replace the light switch by this kind of detector on renovation. However, since the field of vision is limited in this case, the performances of these detectors are often less good than for ceiling-mounted detectors.



↑ Illustration 299 : Various types of dimmer

## Optimizing the lighting system

### 7. WHICH LIGHTING FOR WHICH ROOM?

A few recommendations are given below to improve existing installations in terms of efficacy and the quality of lighting (visual comfort).

A few crucial rooms of the dwelling are reviewed:

#### 7.1. The kitchen

Activities are diverse in the kitchen, and consequently so is the need for light. A distinction is made between the two main areas to be lit: the counters and the rest of the room.

##### - Lighting the kitchen counter

Lighting on the kitchen counter should be relatively strong to allow for precise, and sometimes dangerous, jobs (e.g. manipulating knives). Lighting for the kitchen counter is generally recommended at 300 to 500 lux.

To avoid throwing a shadow on the person working on the counter, the luminaires are preferably placed between eye height and the counter. To achieve this, putting the luminaires under the hanging cupboards seems to be the best solution: light strips as well as spotlights.

##### - Lighting of the rest of the room

Lighting of the rest of the room should be relatively well distributed at about 200-300 lux (at counter height). This prevents strong contrasts between the counter and the rest of the room. To provide lighting in the rest of the kitchen, in practice all types of luminaires can be used. The choice will be based on the occupants' preferences and the size of the room.

#### 7.2. The dining room

The principles for lighting the dining room are similar to those for the kitchen. The following should be provided:

- average lighting of the table at 150 to 200 lux (hanging luminaire)
- lighting of the rest of the room at 100 to 150 lux

#### 7.3. The living room

Lighting needs in the living room can be highly variable, from about 20 to 400 lux.

##### - Light for reading

Lighting for reading is generally located near the armchairs in the living room. Various solutions exist to provide sufficient light:

- a ceiling-mounted luminaire or a hanging luminaire
- freestanding luminaires
- directional luminaires

##### - Lighting of the rest of the room

Depending on the configuration of the room and the choice of luminaires, general back-up lighting (100 to 150 lux) will be needed.

The living room is also the favourite spot for small decorative table lamps. These lamps are generally more decorative than actually intended to provide lighting to carry out a specific task. These luminaires are generally relatively inefficient.

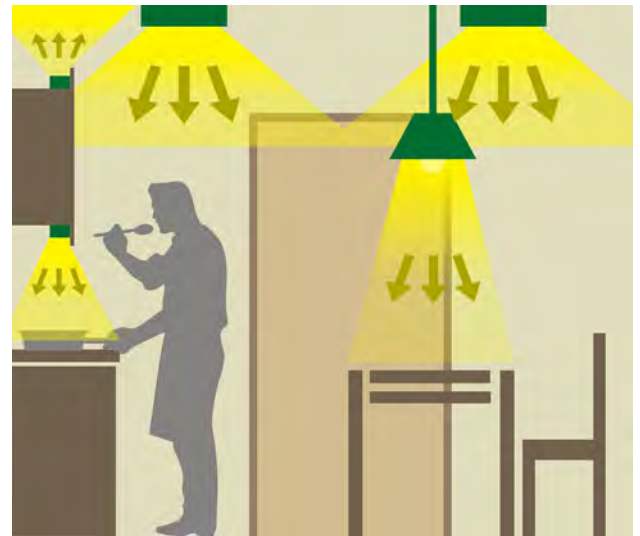

↑ Illustration 300 : How to illuminate the kitchen



# Optimizing the lighting system

N° of Sheet:  
**B24**  
 Cross-references:  
**B11, B18, B25**  
 Appendix:  
 /



↑ Illustration 301 : How to illuminate the bedroom

*The following table compares the intensity of incandescent lamps generally used in residential with the intensity of fluocompact lamps that must be used. Energy savings as well as financial benefits are also calculated for a use of 1000h per year (a little less than 3 hours per day) and a kWh price of 17 cents kWh*

Intensity before replacing	Intensity after replacing	Energy benefits	Financial benefits
100 W	23 W	77kWh	13€
75 W	18 W	57 kWh	10€
60W	15 W	45 kWh	8€
40W	10 W	30 kWh	5€

## 7.4. The bedroom

Lighting in the bedroom can be broken down into three parts:

### - Light for reading or working

Reading requires lighting from 200 to 300 lux. Working needs lighting from 300 to 500 lux.

### - Light on night table and desk lamps

Like the table lamps in the living room, lamps on the night table tend to play a decorative role in addition to providing light for reading. It is rather difficult to find efficient reading lamps on the market.

At this time, we see more and more desk lamps equipped with compact fluorescent lamps with an external ballast. These lamps give good lighting for working and they are efficient. They are almost always equipped with 11W bulbs.

### - Lighting in the rest of the room

Lighting of 100 lux at counter level is sufficient.

The luminaires to be used in the bedroom can be ceiling-mounted or wall-mounted.

Various solutions exist to improve both energy efficiency, comfort of lighting and aesthetics in a lighting installation.

## 8. HOW TO IMPROVE THE LIGHTING INSTALLATION IN RENOVATION?

Various solutions are planned to improve the energy effectiveness as well, as luminous comfort and the esthetics of an installation of lighting.

### 8.1 Light renovation

Light renovation is an opportunity to improve visual comfort and energy efficiency of the lighting installation without making major modifications in the current installation, nor incurring significant costs. This renovation consists of replacing the lamps without changing the luminaires.

Replacing the lamps will bring more or less improvement in the luminous efficacy in the installation and visual comfort, while increasing the lighting.

### 8.2. Intermediate renovation

The construction work for medium renovation will generally be more significant than in the previous section: lamps and luminaires are replaced.

Since the place for the new luminaires is predetermined, the choice may sometimes be limited. In most cases, ceiling-mounted or hanging luminaires will be used.

As concerns the management of lighting, replacing the luminaires can be a good means to add points of control. For example, luminaires with integrated switches can be chosen for situations where specific lighting of a job or separate lighting may be recommended; for example a luminaire over the kitchen counter.

The heavy renovation does not be described in this sheet because it is very similar as a new construction.





## B.2. REDUCE FOSSIL ENERGIES CONSUMPTION

# Renewable energies for generating electricity

N° of Sheet:  
**B25**  
 Cross-references:  
**B22, B24**  
 Appendix:  
 /

The demand for electric energy in a building can easily be reduced by a number of measures such as promoting natural lighting, choosing energy-saving electric appliances, and so on.

Once these measures have been taken, the question arises as to the impact of the generation of electricity that is used on a day-to-day basis. This generation is not entirely environment-friendly today – despite growing installations of renewable systems (wind power, photovoltaic energy, cogeneration, ...) most generation is still either nuclear or based on fossil fuels.

Given this observation, recent studies consider that in industrialized countries, photovoltaic energy could supply 50% of consumption in the residential sector, or 10% of the total consumption of electricity.

Generating electricity from an inexhaustible source – the sun – is an economic, industrial and environmental challenge that each country should take up, as has been done in Germany and Japan that together produce nearly 70% of the world's solar power.

### 1. PRELIMINARY REMARK

At this time, there are different sources of renewable energy to generate electricity:

- Solar energy
- Wind energy
- Hydraulic energy
- Biomass
- Cogeneration of electricity

Developing and increasing all these sources should be promoted in a general way, but on the scale of housing and renovation, the only two generation systems that can be easily integrated are:

- Photovoltaic solar energy that applies both to individual homes and collective housing
- Cogeneration of electricity that today is used only for large collective housing developments.

In this information sheet, we will talk about generating electricity by means of solar panels, which is advantageous both financially and for the environment.

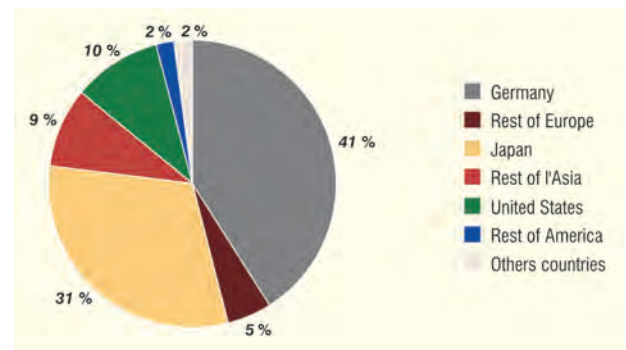

↑ Illustration 302 : World repartition of solar electricity



↑ Illustration 303 : Wind power



↑ Illustration 304 : Solar energy

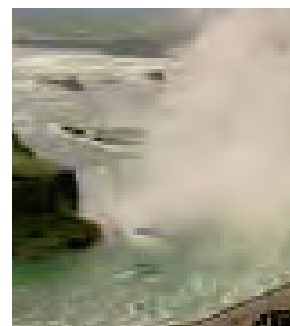

↑ Illustration 305 : Hydro power



↑ Illustration 306 : Biomass

#### **Why switch to renewable energies?**

80% of the energy used in the world is based on fossil energy sources. Most of these sources will be exhausted in a few decades and the consequence will be a significant rise in purchasing prices (due to the phenomenon of supply and demand).

Moreover, many deposits of these resources are located in politically unstable or hard-to-reach places which makes procurement difficult. This is another reason for rising cost.

But even more, these fossil resources must be burned to produce energy which has an impact on many pollution-related problems today (global warming, acidification of the environment, formation of tropospheric ozone) and on health (respiratory problems, allergies, ...).

**2. HOW IT WORKS**

**2.1. Photovoltaic effect**

The photovoltaic effect was discovered by Alexandre Edmond Becquerel in 1839. The photovoltaic effect is obtained by the absorption of photons in a semiconductor material that then generates an electric current.

**2.2. How it works in the home**

Direct current is generated in the cells of the solar module by the effect of the light. All of the modules connected together form the photovoltaic «generator».  
 The direct current produced is linked to the connecting box on the generator and is carried to the converter.  
 The inverter transforms the direct current into alternating current (average voltage – 220 to 240V).

At this point, there are two possibilities:

- All of the alternating current is supplied to the public electricity network via a power supply meter. The receivers get the power they need from the local electric grid via a separate subscription meter;
- The alternating current generated is not connected to the public network and is either consumed on the spot, or is stored in accumulators.

*Note that the inverter must be placed on a vertical support and in a ventilated space. It must be also placed as close as possible to the panels because losses of electricity are much higher on transporting direct current than for alternating current.*

**3. GENERAL NOTIONS: SILICON PLATES – CELL – MODULE – GENERATOR**

The basic material of the crystalline solar cells is a silicon plate (0.2 to 0.3 mm) called a «wafer». The photovoltaic effect takes place inside these small units.

When the various layers of the semiconductors that make up the solar cell are lit by sunlight, a difference in potential appears. This phenomenon can be measured externally by voltage. For silicon, it is 0.6V on the average. To be used, the voltage must be amplified by mounting several cells in a series.

A module generally consists of solar cells mounted in a series. The maximum number of cells (= voltage of the module) is in principle limited by the conditions of implementation of the module (weight and size).

When several modules are mounted in a series to make a photovoltaic installation, this is called a row or a string. All of the strings of modules combined together (even if there is only a single string) make up the generator.

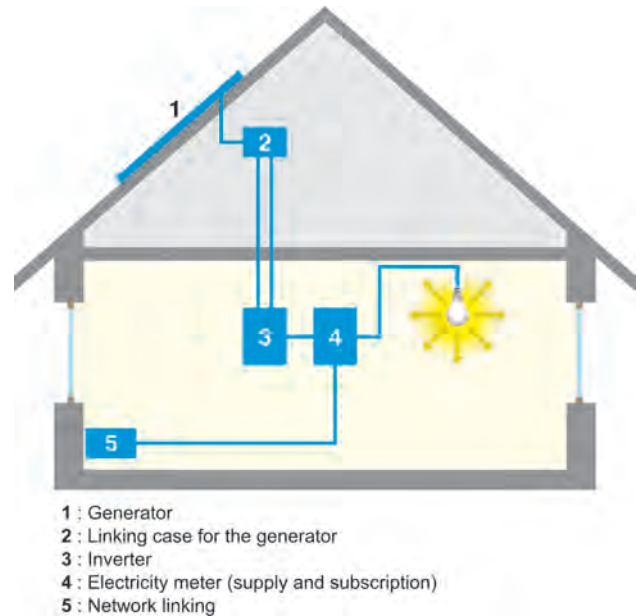

↑ Illustration 307 : Installation diagram

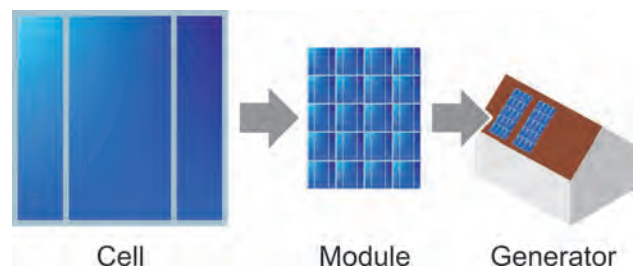

↑ Illustration 308 : Concept : cell - module - photovoltaic generator

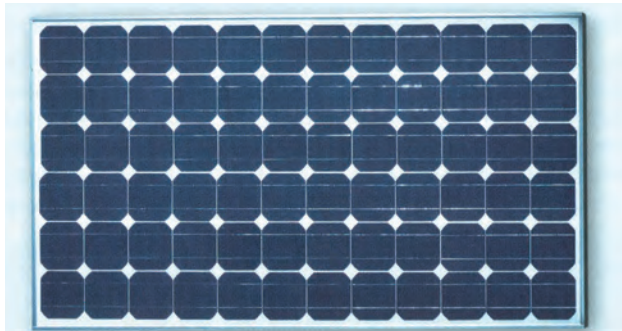

↑ Illustration 309 : Cell with single crystal silicon

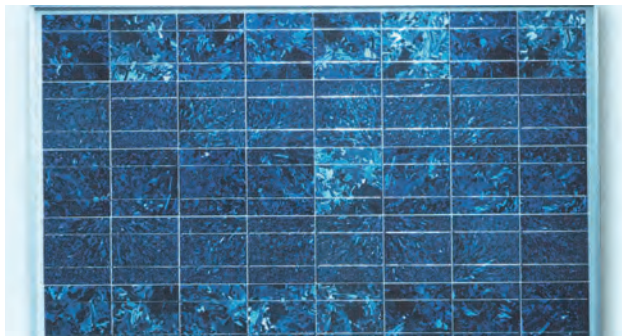

↑ Illustration 310 : Cell with polycrystal silicone

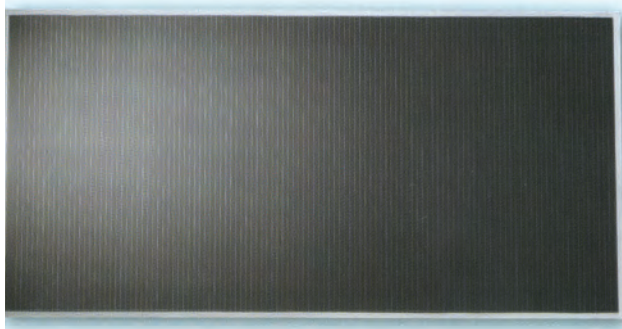

↑ Illustration 311 : Cell with amorphous silicon

**4. PHOTOVOLTAIC CELL**

**4.1. Type of photovoltaics cells**

There are different types of photovoltaic cells, depending on the technology used. At this time, crystalline silicon cells are most frequently used.

The cells can be divided into four groups according to the basic material:

**- Monocrystalline silicon cell**

Monocrystalline cells are manufactured by the fusion of very pure silicon. In this technology, round silicon bars are made and sliced into plates 0.2 to 0.3 mm thick. These plates are the basis of the monocrystalline cells. Although their manufacture requires more energy and time than polycrystalline cells, efficiency is the highest of all types of cells.

**- Polycrystalline silicon cell (or multi-crystalline cells)**

Fusion is also used to manufacture polycrystalline silicon. In this process, the rough silicon is heated to a high temperature and then shaped in a mould. As it solidifies, crystals form in an irregular pattern.

The square bars are cut in slices of 0.3 mm.

The habitual blue colour results from the anti-reflection coating applied which changes the thickness and consequently the colour.

**- Thin layer cells (CIS, CdTe, GaAs)**

Despite their relatively limited yield, thin layer CIS (copper indium diselenid) cells and CdTe (cadmium telluride) cells represent a good alternative thanks to the greater tolerance of shadow (elements that mask the luminous rays) and the reduced loss of yields due to an increase in temperature.

**- Amorphous silicon cells**

Cells made from amorphous or nonstructured silicon that is not in crystalline form are already often used in calculators and watches.

The yield of the cells on the averages ranges from 6 to 8%. The active semiconductor material is considerably thinner than in crystalline cells. Consequently, less material is needed for the cells than for crystalline silicon cells.

Cell material	Module output	Needed aera for 1kW peak (mid-Europe)	Part world market
Cellule monocristalline	11 - 16%	7 - 9m <sup>2</sup>	93%
Cellule polycristalline (EFG)	10 - 14%	8 - 9m <sup>2</sup>	
Cellule polycristalline	8 - 10%	9 - 11m <sup>2</sup>	
Cellule en couches minces CdTe	6 - 8%	11 - 13m <sup>2</sup>	1.7%
Cellule amorphe	4 - 7%	16 - 20m <sup>2</sup>	4.5%

↑ Source : «Le photovoltaïque pour tous, conception et réalisation d'installations», Editions le Moniteur

# Renewable energies for generating electricity

## 4.2. How a crystalline cell works

Targeted doping with unrelated atoms (generally boron and phosphorus) creates two layers in the cell with different electric properties:

- a positive layer « p »
- a negative layer « n »

an electric field forms at the junction of these two layers, this is the space charge zone (SCZ).

When light strikes the cell, the electric charges located in this space charge zone separate. In the electrical connection this generates a DC voltage of about 0.5V on the average, that depends little on the light provided.

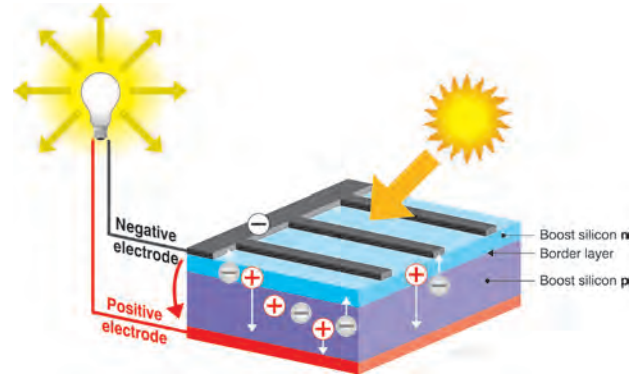

↑ Illustration 312 : Working principle of a crystalline cell

## 4.3. Peak power

The current and electric power of a solar cell depends directly on the intensity of the luminous flux.

The energy provided by the cells is at a maximum when the sky is clear and sunny. In the case of cloud cover, the luminous flux is lower and consequently there is less power.

The maximum power of a cell is defined for a luminous flux of 1000 W/m<sup>2</sup> at a temperature of 25°C. This is called the peak capacity and is expressed in Wp (watt peak).

## 4.4. Intensity and voltage

A solar cell is characterized by:

- electric intensity: this depends on the power of the luminous flux and the size of the cell
- electric voltage: this depends essentially on the material that makes up the cell

The only way to increase voltage is to mount several cells in a series.

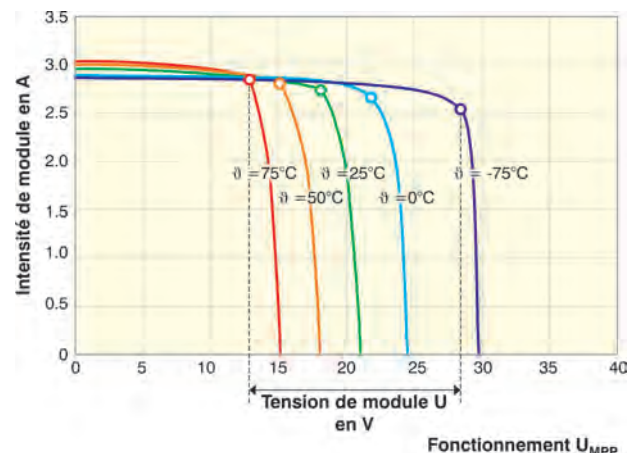

↑ Illustration 313 : Impact or influence of temperature

## 4.5. Influence of temperature

A heating solar cell loses its efficiency. For crystalline cells, the loss of efficiency corresponds to 0.5% per degree Celsius. For this point, thin layer cells are less sensitive than crystalline silicon cells. Consequently, any heating should be avoided. For this reason, installations that allow for ventilation on the back of the module should be preferred.

## 5. PHOTOVOLTAICS MODULE

A photovoltaic module generally consists of:

- several solar cells linked together;
- glazing (or stratified) protection against the weather
- protection against overvoltage using one or several bypass diodes
- a branching device
- glazing on the back
- an aluminum frame

To manufacture a module, several cells are connected together electrically (in a series) to reach useful voltage and intensity at the module outlet. Each series is protected by a bypass diode that

- prevents the heating of certain cells from causing a shutdown or deterioration in the case of shadow;
- limits the drop in performance resulting from this heating of the entire module.

↓ Illustration 314 : Photovoltaics module

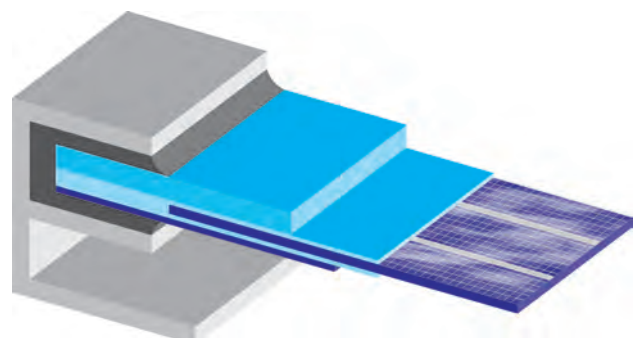

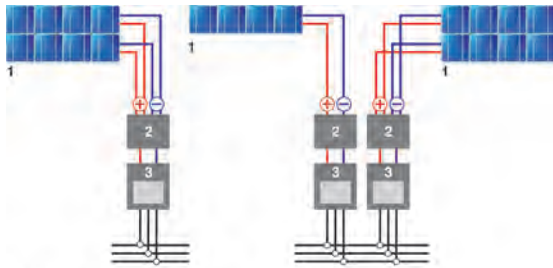

1: generator  
 2: connexion box  
 3: inverter

↑ Illustration 315 : Various types of inverter installation



↑ Illustration 316 :  
 The solar collectors, with different orientation, must be connected in parallel

**6. CONVERTER**

**6.1. Type of converter**

The converter transforms the continuous current provided by the photovoltaic generator into single-phase alternative current with a nominal voltage of 230V.

Depending on the photovoltaic installation, there are different types of converters: centralized converters, string and multi-string converters and modular converters.

A centralized converter is commonly used for individual homes where the modules all point in the same direction and have the same inclination. For a powerful generator, when the cells are partially shaded or when the modules present different inclinations and/or orientations, string (multi-string) converters for modular converters are used.

**6.2. Converter and branching of modules**

For a parallel connection, currents of the various modules add up and the voltage remains the same.

For a serial connection, the voltages add up and the current going through them is the same.

**- When do the modules have to be connected in a series**

For individual installations, without significant shadow, connection in the series will be chosen as long as all the modules are oriented the same way and have the same inclination.

**- When do the modules have to be connected in a parallel connection?**

A parallel connection has to be used for the modules or strings of modules if:

- part of the installation is in the shade
- the modules do not have the same orientation and inclination
- the voltage in the installation is higher than permitted when a serial connection is used

**7. INSTALLATION**

**7.1. Installation on the roof or on the façade?**

Photovoltaic solar modules can be mounted in several ways according to esthetic and financial criteria (see table on the next page)

**7.2. Orientation and inclination**

To maximize the generation of electricity in an installation, the modules should be oriented and inclined so as to receive as much radiation from the sun as possible.

**- Orientation**

Generally speaking, in the Northern Hemisphere, the modules will face south or nearly south (southeast or southwest).

**- Slope**

As for the inclination of the panels compared to a horizontal plane, the approach is based on the height of the sun in the sky. The height of the sun depends both on the latitude of the project and the season. Solar energy received by the surface of the modules will be greater if this surface is perpendicular to

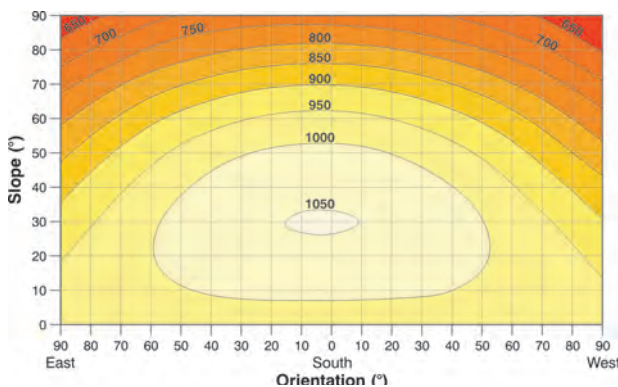

↑ Illustration 317 : Influence of the orientation and slope on the efficiency

## B.2. REDUCE FOSSIL ENERGIES CONSUMPTION

# Renewable energies for generating electricity

N° of Sheet:  
**B25**  
 Cross-references:  
**B22, B24**  
 Appendix:  
 /

Type of assembly	Advantages
Assembly detached from the slope of the roof	<ul style="list-style-type: none"> <li>• Simple, quick, inexpensive mounting with no affect on the water tightness of the roof</li> <li>• In renovation, ideal installation on existing roof</li> <li>• Good ventilation on the back on the modules to cool them</li> <li>• High-efficiency (if there is little shadow)</li> <li>• Easy to disassemble</li> </ul>
Mounting integrated in the roof	<ul style="list-style-type: none"> <li>• Esthetically attractive</li> <li>• High-efficiency (if there is little shadow)</li> </ul>
Mounting on a flat roof	<ul style="list-style-type: none"> <li>• Ideal orientation and inclination of the modules</li> <li>• Good ventilation on the back on the modules to cool them</li> <li>• Simple, quick, inexpensive mounting with no affect on the water tightness of the roof</li> <li>• High-efficiency (if there is little shadow)</li> <li>• Simplified disassembly, repair and maintenance</li> </ul>
Mounting on a free area on the ground	<ul style="list-style-type: none"> <li>• Ideal orientation and inclination of the modules</li> <li>• Good ventilation on the back on the modules to cool them</li> <li>• Simple, quick, inexpensive mounting with no affect on the water tightness of the roof</li> <li>• Simplified disassembly, repair and maintenance</li> </ul>
Mounting on the façade	<ul style="list-style-type: none"> <li>• Certain savings are made: the external envelope is replaced partially by photovoltaic modules</li> <li>• Esthetically attractive</li> <li>• Large vertical area available</li> </ul> <p><i>Note that because of the limited slope of the modules, efficiency obtained with an assembly on the façade is significantly lower than an assembly on the roof.</i></p>



↑ Illustration 318:  
Installation on a roof



↑ Illustration 319:  
Installation on a flat roof



↑ Illustration 320:  
Installation on façade

the sun's direct rays.

### - Orientation and slope: factor of correction for Mid-Europe

Optimum efficiency is reached for an orientation to the south with an inclination of 35° from a horizontal plane.

Efficiency decreases on moving away from this position. To put a figure on this decrease in efficiency, a correction factor is applied on the kWh obtained per year and per kWp. The values of this correction factor are given in the table below.

© <a href="http://www.ef4.be">www.ef4.be</a>		inclinaison par rapport à l'horizontale (°)						
		0	15	25	35	50	70	90
orientation	est	88%	87%	85%	83%	77%	65%	50%
	sud-est	88%	93%	95%	95%	92%	81%	64%
	sud	88%	96%	99%	max 100%	98%	87%	68%
	sud-ouest	88%	93%	95%	95%	92%	81%	64%
	ouest	88%	87%	85%	82%	76%	65%	50%

↑ Illustration 321: Factor of correction facing to orientation and slope





↑ Illustration 322: Follow-the-Sun» System

### - Follow-the-Sun» System

There are mobile installation systems that «follow the sun», providing maximum generation of electricity by following the sun on its daily course (in orientation and inclination). This type of installation increases generation by about 25% as compared to a fixed installation. On the other hand, this type of installation entails significant additional cost, and is hard to integrate in an individual home or in a small collective housing complex.

### 7.3. Shadow

Much more than the loss of efficiency that may occur with poor inclination or poor orientation, shadow puts a high penalty on the efficiency of photovoltaic panels. The modules are made up of cells connected in a series. This serial connection means that the cell with the lowest efficiency will determine and limit the power of the entire module.

Consequently, one must:

- limit shadowing of the modules to a maximum
- provide for connections that take account of shadowing

### 7.4. Protection from lightning

Generally speaking, if the building has a lightning protection device, the photovoltaic installation should be connected to it. However, the need for protection against lightning is closely related to the way the installation is mounted:

- A photovoltaic installation when it is mounted on a sloped roof, does not generally increase the risk of being hit by lightning. This kind of installation therefore does not need special protection.
- In the case of an installation on a flat roof, the modules generally go beyond the roof, and these installations must be considered on a case-by-case basis.

In any case, the metal components of the installation should be connected to the main grounding of the building.

## 8. DIMENSIONING OF THE INSTALLATION

The dimensioning of an installation essentially depends on:

- the characteristics of the roof (size, inclination, orientation)
- the absence of shadow or an obstacle to the sun's rays
- the available financial capacity of the investment
- the technical and esthetic requirements of the contracting authority

In general, the maximum size of the installation is limited by the available area of the roof.

The area required for installation depends on the technology of the cells.

*Example:*

*a 1 kWp generator requires the following service areas:*

- 6-9 m<sup>2</sup> of monocrystalline cells
- 7-10 m<sup>2</sup> of polycrystalline cells
- 15-20 m<sup>2</sup> of amorphous cells





## B.2. REDUCE FOSSIL ENERGIES CONSUMPTION

### Heat recovery on ventilation system

N° of Sheet:  
**B26**  
Cross-references  
**A20, A21, B19, B28**  
Appendix  
/



Picture: T. Demeester

The portion of the building's energy consumption devoted to heating new air increases with the degree of insulation and airtightness of the envelope. In a well insulated building, losses from ventilation will be 40 to 70% of total losses (60 to 80% in an apartment in the middle of the complex). On insulating an existing dwelling and putting in structured ventilation, it is important to combine a means of recovering the heat of the air extracted from the building. Depending on the thermal efficiency of the recovery, energy consumption from ventilation can be reduced by 50 to 95%.

#### 1. HOW IT WORKS

A heat recovery system has a heat exchanger allowing heat transfer. The polluted air and new air go through the exchanger. The heat of the polluted air evacuated to the outside is used to preheat air coming in from outdoors. Only the heat is transferred; the two flows do not come into contact with each other.

This thermal exchange considerably reduces energy consumption needed to heat the fresh outside air to a comfortable temperature for the air supply. In fact, a heat recovery system can recover 70 to 80% (or, for the most effective, even 90 to 95%) of the heat of the exhaust air and transfer it to the flow of new incoming air.

For the renovation of housing, using a heat recovery system for extracted air requires a dual flow mechanized ventilation system in which the extraction fan is located near the air supply fan.

#### Example:

For heat recovery system with thermal efficiency of 80%: if the outside air is at 0°C and the indoor air is at 20°C, after going through the heat recovery system, the incoming air supply is at 16°C without requiring any consumption of heat.

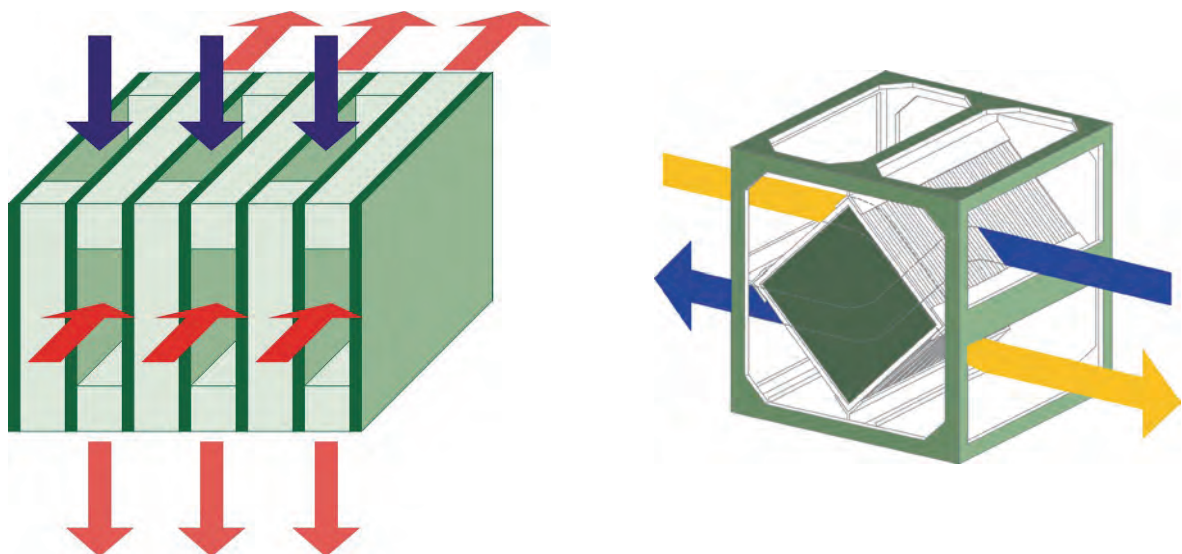

**2. HEAT RECOVERY SYSTEM**

**2.1. Type of heat recovery system**

**- Monoblock heat recovery system**

For ordinary flows needed in traditional homes, current heat recovery systems are in monoblock units and consequently, they are mounted in the same caisson as the dual flow ventilation system.

They essentially comprise:

- a multi- or variable speed air supply fan, on the side of the new air intake;
- a multi- or variable speed extraction fan, on the side of where the polluted internal air is extracted;
- 2 filters for incoming and outgoing air;
- a by-pass of the heat exchanger in the new air circuit to avoid unnecessary reheating under certain weather conditions.

This is particularly useful on summer nights, when outdoor air is often cooler than the air in the house.

**- A separate heat recovery system**

For apartment buildings, where flows can be greater, central air treatment units may be advisable. In this case, the fans are separate from the heat economizer. This solution requires aeraulic connections between the fans and the heat recovery system that must be mutually compatible.

**2.2. Advantages and disadvantages**

A heat recovery system can recover up to 85% of heat from polluted air, which can reduce energy consumption by 50 to 95%.

On the other hand, a heat recovery system entails:

- an additional investment at the time of the renovation;
- more room for the technical installations;
- greater friction loss in the installation.

**3. INSTALLING A HEAT RECOVERY SYSTEM**

**3.1. Individual housing**

The space needed to install a monoblock heat recovery system in an individual home is relatively small. However, for renovating, the installation of this type of system is complex.

By and large, the ideal spot for the installation of the heat recovery system is in an attic, and in the least favourable case, in a technical zone in the upper storeys.

If the premises where the system is installed are relatively poorly insulated from the outdoors:

- the external fresh air intake ducts must be insulated
- the polluted air outlet ducts must be insulated to reduce the risk of condensation and freezing. The heat exchanger itself is always insulated.

**3.2. Collective housing**

**- Individual heat recovery system for the fresh air supply /common extraction**

Putting dual flow ventilation in an apartment building means fitting out vertical technical shafts to distribute new air and to collect polluted air from each apartment. A heat recovery system itself should be put in technical premises near the shaft.

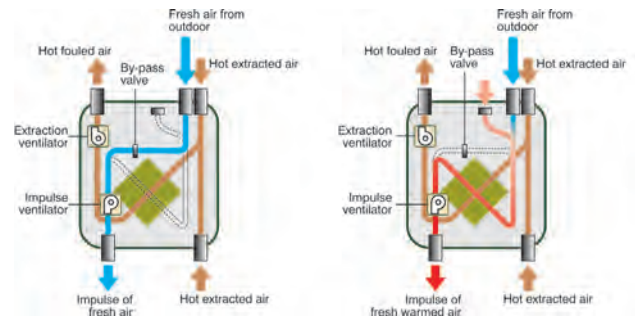

↑ Illustration 324 : Working of a heat recovery system

*It is important to say that in Northern countries and in Mid-Europe, it is not possible to build or renovate according the passive standard and get such low energy levels for heating without using a heat exchanger*

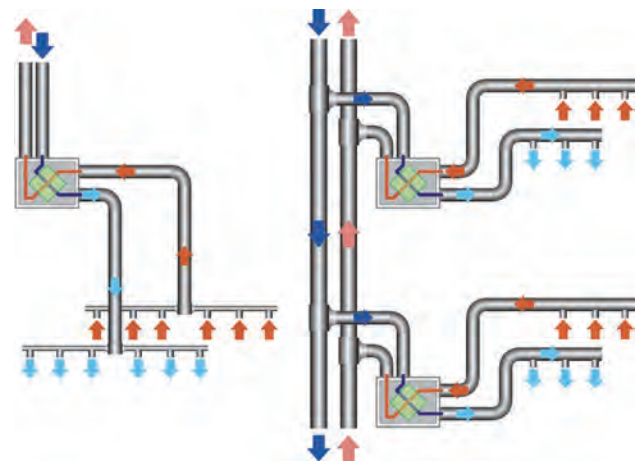

↑ Illustration 325 : Implementation of an heat recovery system in individual housing

↑ Illustration 326 : Implementation of heat recovery system in a collective housing (1/dwelling)

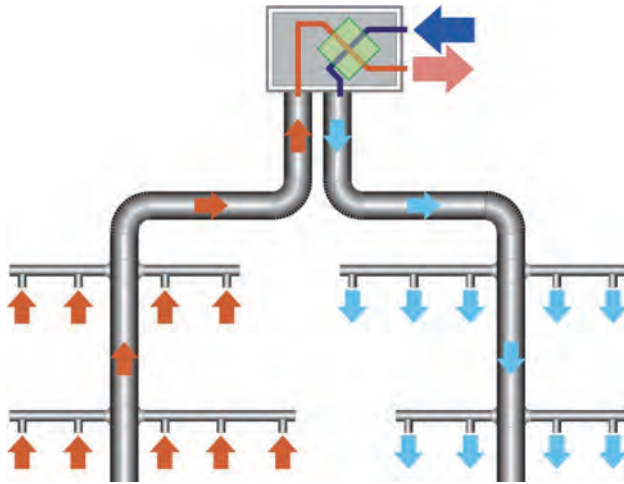

↑ Illustration 327 :  
 Implementation of heat recovery system in a collective housing  
 (1 for all dwellings)

Distribution downstream from the recovery system into the apartments is more of a problem, since the air supply and extraction ducts have to be put in false ceilings.

- (+) This system allows for local regulation per apartment (controlling air flows for each tenant or apartment owner).
- (-) More maintenance is needed.

These comments should be taken into account given the purpose of the apartments (social housing for example).

**- Individual heat recovery system /common extraction**

If the vertical technical shafts are too small to house two sets of ducts, an alternative is to provide for new air intake from the façade on each floor (be attentive to pollution problems) and to reject the polluted air at roof level by means of a common vertical duct.

**- Collective heat recovery system with common vents**

When it is not possible to install an individual heat economizer per apartment, a collective heat economizer can be placed in technical premises insofar as the distribution of the air supply and extraction to and from each apartment can be done via vertical shafts.

- (+) Rationalized maintenance.
- (-) Common regulation.

**3.3. Combined with a ground heat exchanger**

Dual flow ventilation can be combined with a ground heat exchanger (see information sheet B27).

If this is the case, the ventilation installation must take account of friction loss caused by the ground heat exchanger.

The ground heat exchanger is connected at the air intake of the ventilation system.

It has the following advantages and disadvantages:

- Preventing freezing of the recovery system by preheating incoming air;
- Improving comfort in the summer by cooling incoming air, which cannot be done simply with the heat economizer;
- Very expensive investment;
- Most of the time, the ground heat exchanger gives only a marginal improvement of the energy efficiency of an installation with a heat economizer (on its own the heat economizer reduces energy consumption by 50 to 95 %);
- Problem of compensation and additional maintenance for the ground heat exchanger.

**3.4. Maintenance**

In apartment buildings, maintenance of the heat recovery systems (mainly the filters) can be limited or substantial depending on how many there are and how difficult it is to gain access to them.

The filters should be cleaned and/or replaced twice a year.

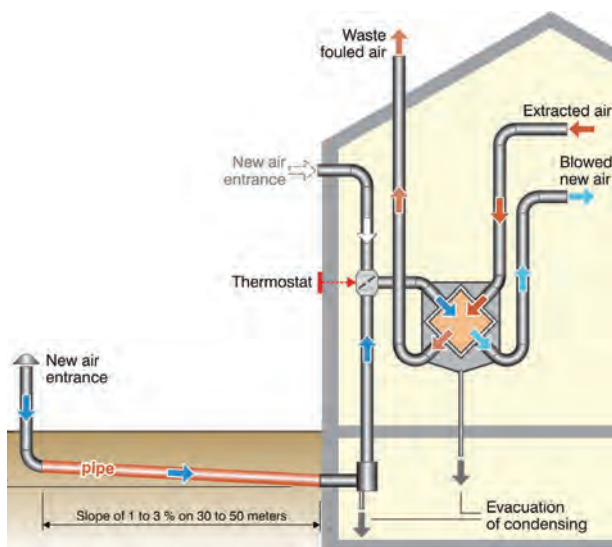

↑ Illustration 328: Principle of air ground exchanger

#### 4. ENERGY GAINS

The energy efficiency of heat recovery system should be combined with limited internal friction losses:

- high thermal efficiency (of 90-95 %) limits consumption due to heating air;
- limited internal friction losses (due to filters, ducts, valves, ...) reduce electricity consumption of fans.

Under these circumstances, as part of the energy saving measures at the time of renovation, it is important to choose a heat recovery system corresponding to the following criteria:

- providing the minimum level for thermal efficiency;
- fans with a specific capacity.

Using a heat recovery system with thermal efficiency of more than 90%, equipped with a regulation system allowing for a recovery throughout the entire heating season (management of de-icing) can save on the investment in post heating coils and the installation for producing heat.



## B.2. REDUCE FOSSIL ENERGIES CONSUMPTION

# Air pre-heating/cooling by airground exchanger

N° of Sheet:  
**B27**  
 Cross-references:  
**A21, B20, B26**  
 Appendix:  
 /



In a well-insulated building, the heat losses associated with hygienic ventilation become the most important item for energy consumption. Action can be taken to rationalize this consumption, particularly by preheating the air supply through a ground heat exchanger.  
 A ground heat exchanger is also presented as an advantage for comfort in the summer, because it can cool down the air before supplying it to the building.  
 The effectiveness of a ground heat exchanger depends on its size, its depth underground, the composition of the soil, its shape, and the materials used.  
 In addition, installing a ground heat exchanger in an existing dwelling is not easy given the obvious cost of implementation, and available space, ... so the project must be treated circumspectly on a case-by-case basis.

Picture from Architecture et Climat

### 1. PRINCIPLE

A ground heat exchanger is a geothermal system that uses the heat in the soil to pre-heat or cool the new air for ventilation. The temperature of the outer air may vary from -20°C to +40°C throughout a year, but the temperature of the soil 2 metres deep is stable between 5 and 15°C on the average depending on the season.

The principle is to circulate the new ventilation air in an underground duct before supplying it to the dwelling:

- in the winter, the air is heated as it goes through the heat exchanger, and consequently energy consumption for reheating is reduced;
- in the summer, the outdoor air takes advantage of the cool soil to become cooler, and consequently to improve thermal comfort in the summer.

↓ Illustration 329 : Installation principle

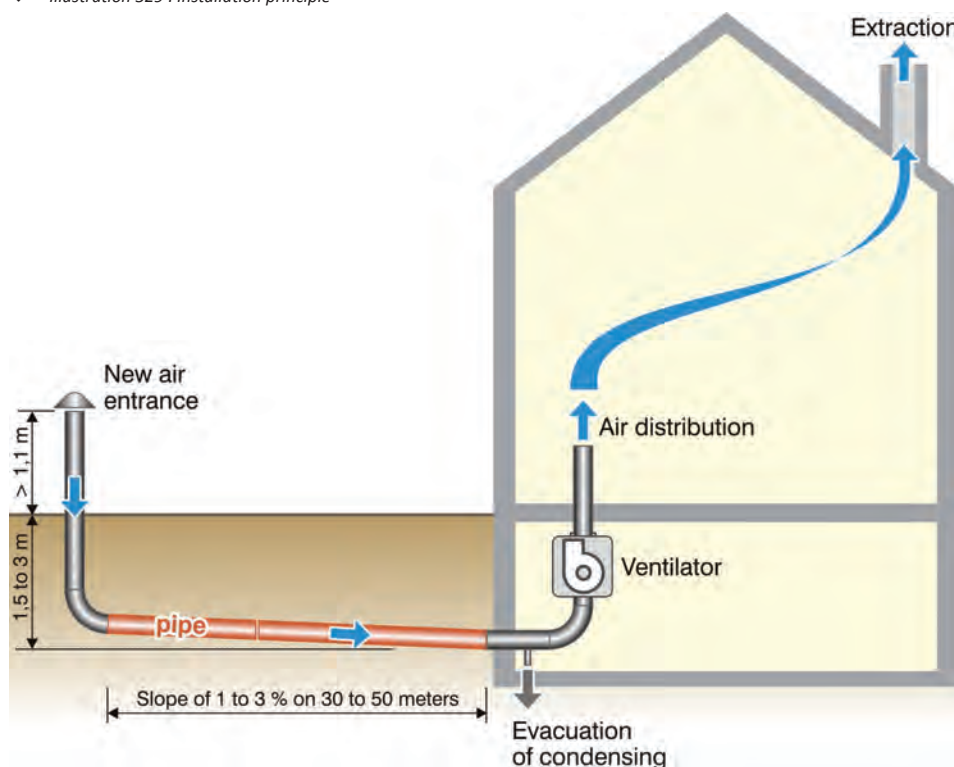

↑ Illustration 330 : New air entrance

↓ Illustration 331: Condensing evacuation

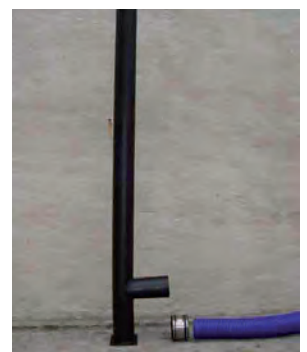

**2. DESIGN ELEMENTS**

The following elements should be taken into account in designing a ground heat exchanger:

**2.1. The nature of the soil**

The performances of the heat exchanger are directly related to the heat capacity and thermal conductivity of the soil.

*- Thermal conductivity of the soil*

The thermal conductivity of the soil depends both on its composition and on the layout and shape of the particles that make it up, connections between these particles and its water content. The damper the soil, the higher its thermal conductivity.

*- Heat capacity of the soil*

The heat capacity of the soil is expressed by the weighted average of the heat capacities of its components: minerals, organic matters, presence of air and water (see the table in Annex).

**2.2. Geographic location**

In regions where the climate has very low temperatures in the winter and very high temperatures in the summer (>20°C difference between hot and cold), a ground heat exchanger can play an advantageous role, particularly since the soil temperature is constant.

**2.3. Available room and cost**

In renovation, the cost of putting in a ground heat exchanger is high as compared to designing one in a new construction, since one cannot take advantage of the earth works on the building to dig a trench for the heat exchanger.

In addition, this can only be done if the dwelling has sufficient grounds and is accessible to civil engineering machines.

**2.4. Combined ventilation mode**

A ground heat exchanger occasions friction losses. Mechanical ventilation must be calculated to overcome these friction losses.

In the case of heavy renovation of an existing building, no efficient mechanical ventilation system is designed today without combined heat recovery. This considerably reduces the energy impact of a ground heat exchanger for preheating the hygienic air supply (see information sheet B26).

**2.5. Friction losses**

Friction losses caused by the heat exchanger are essentially due to:

- the shape of the duct or ducts
- the air speed
- the material used for the duct

These friction losses must be overcome by the air supply fan in the ventilation system. To reduce energy consumption of that system, a ground heat exchanger must be highly effective. When the size is calculated well, a ground heat exchanger has a thermal efficiency that is often about 80% when friction losses are limited.

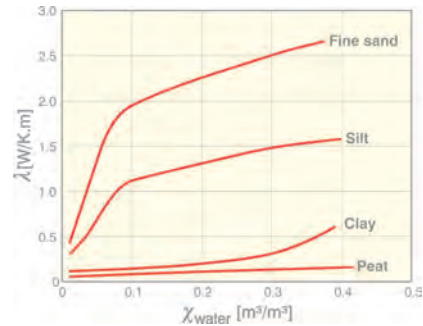

↑ Illustration 332: Nature of different type of grounds

Type of ground	Density kg/m³	Heat storage capacity c kJ/kg.K	Thermal conductivity W/m.K
Minerals	2650	0.8	2.9
Sand / gravel	1700 à 2000	0.91 à 1.18	2
Clay and silt	1200 à 1800	1.67 à 2.5	1.5
Water	1000	4.2	0.25
Ice	920	2.1	0.58
Air	1250	1	2.2
Organic matter	1300	1.9	0.023

Source: Guide Pratique pour la construction et la rénovation durables de petits bâtiments, IBGE, Bruxelles, 2007



# Air pre-heating/cooling by airground exchanger

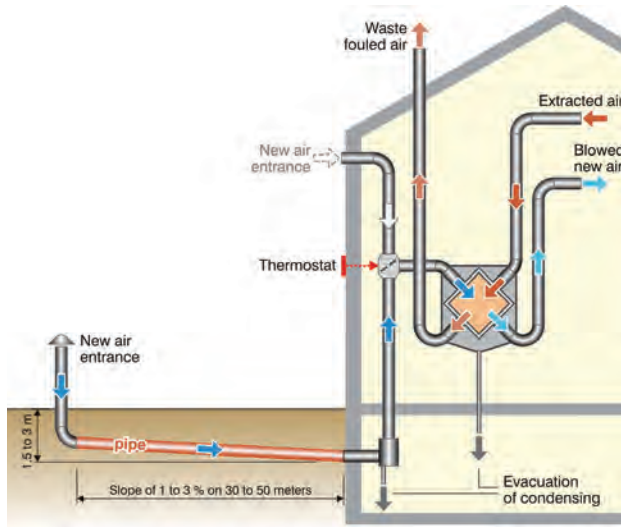

↑ Illustration 333 : Air recovering system coupling with an airground exchanger

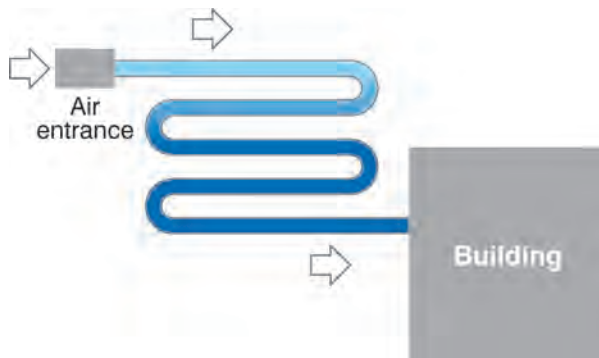

↑ Illustration 334 : Pipes implementation: meandering between air entrance and housing

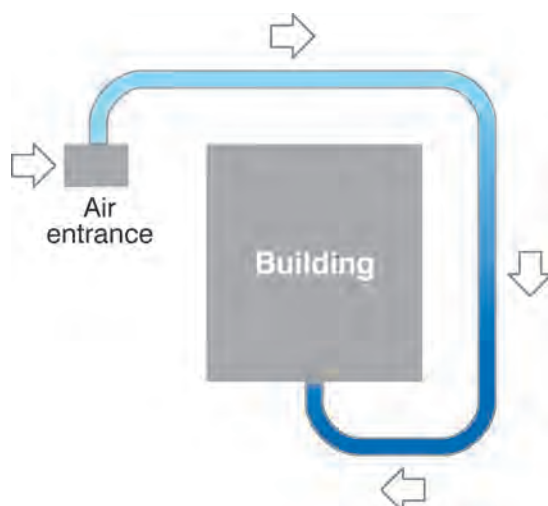

↑ Illustration 335 : Pipes implementation : circle around housing

**Example :**

- $t^{\circ}$  entrance of the heat exchanger =  $-8^{\circ}\text{C}$  ;
- $t^{\circ}$  soil =  $10^{\circ}\text{C}$  ;
- efficiency of the heat exchanger = 80 %
- temperature of the outlet air:  $- 8 + (10 - (- 8)) * 0,8 = 6,4^{\circ}\text{C}$

**3. DIMENSIONING AND IMPLEMENTATION**

A ground heat exchanger consists essentially of:

- a fresh air intake
- one or several underground ducts
- a system for evacuating condensates
- connection to the ventilation network

**3.1. Air intake**

**- Air intake**

The air intake in general is an opening outdoors, far from any source of traditional pollutants, allergens, or sources of odours. For this reason, putting a ground heat exchanger in an urban environment is generally problematical.

The air intake should be:

- at least 110 cm under the ground;
- be protected from infiltration of rainwater by a cover;
- be protected from intrusion by small animals with a fine grid.

**- Filters (pollens and dust)**

A filter is placed at the entrance of the heat exchanger to reduce the entrance of dust, pollen and particles. This filter should be cleaned or changed regularly so as not to increase friction losses and energy consumption of the fan.

**3.2. The underground duct**

**- Number of tubes**

The duct of the heat exchanger can consist of a single tube placed in a loop around the building or a network of parallel tubes.

**- The length of the duct**

The length of the duct is calculated in view of the desired airflow, the nature of the soil, the location and the type of installation chosen.

The total length of each tube on the average is between 30 and 50 metres, to limit friction loss.

**- Air speed and diameter of the duct**

To optimize the soil/air heat exchange, the air speed should be between 1 and 3 m/s.

The diameter of the duct should be calculated based on these air speed conditions.

**- Layout and implementation**

To minimize friction loss in the duct and facilitate maintenance, the number of bends should be limited.

The depth of the duct is between 1.5 and 3 metres.

The duct should be at a slope (between 1 and 3%) to promote evacuation of condensates.

## Air pre-heating/cooling by airground exchanger

### - Material

The choice of materials is important because it has direct impact on the soil/air heat exchange.

The ducts are made from synthetic materials (PVC, polyethylene, polypropylene).

The tubes can also be treated against germs (using silver salts) to prevent odours from developing.

### 3.3. Evacuation of condensates

Water vapor contained in the air that circulates in the duct can condense when the air is in contact with the cold sides of the duct.

To prevent this water from stagnating and the development of germs and bacteria that could disturb air circulation and decrease its quality, the system must necessarily be equipped with

- a duct at a slope
- a system for evacuating condensates

### - Presence of a basement

The condensates can be recovered inside the dwelling. They are then evacuated to the collective sewer by a siphon.

### - In the absence of a basement

An opening should be put in at the lowest part of the duct, to evacuate the condensates:

- by infiltration into the soil
- by pumping them up

This opening should allow for visual inspection of the state of the duct

### 3.4. Fan and regulation

#### - Performance

The size of the fan should be determined in view of the flow of air needed (see information sheet A21).

#### - By-pass et thermostat

In the midseason when the outdoor temperature is between 10 and 20°, the use of a ground heat exchanger is not recommended (outdoor air close to a comfortable temperature). It is preferable to disconnect the heat exchanger by using a bypass to get a direct new air supply.

The bypass is generally controlled by a servomotor connected to a thermostat located outside the building.

### 3.5. Maintenance

The heat exchanger should be maintained regularly once or twice a year:

- replacing or maintaining the intake filter;
- inspection of the duct or ducts;
- evacuation of the condensates

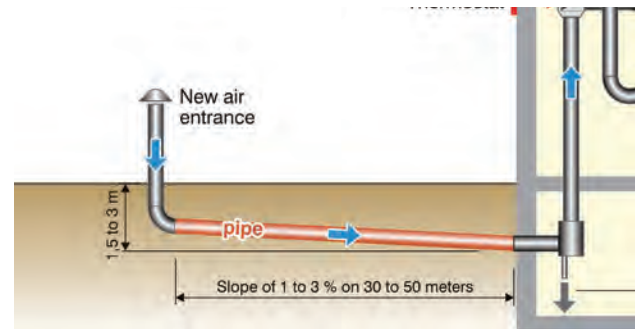

↑ Illustration 336: Installation of condensing evacuation

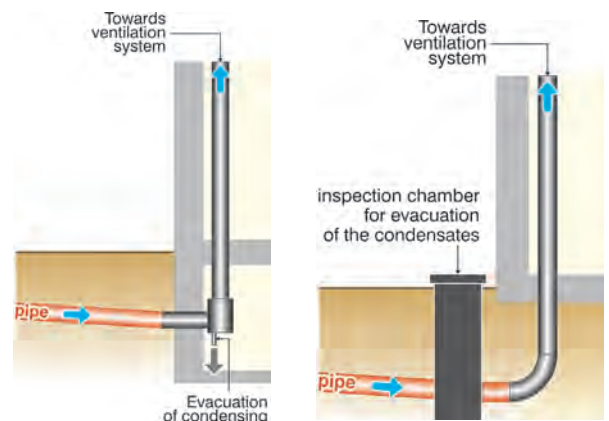

↑ Illustrations 337 and 338: Two systems for condensing evacuation

### ENERGETICAL GAINS

A ground heat exchanger can make savings of about 20 to 25% of the energy consumption associated with heating incoming air (5 to 10% of total heat consumption) and can provide moderate cooling in hot weather.

Note that when the heat exchanger is combined with a heat recovery system and a double flow mechanical ventilation system, its efficiency becomes insignificant as compared to that of the heat recovery (70 to 90%).

## C. REDUCE TAP WATER CONSUMPTION

C01 - Rational use of tap water

C02 - Recovery and use of rainwater

*Picture from Sophie Trachte*





## C. REDUCE THE TAPWATER CONSUMPTION

### Rational use of tap water

N° of Sheet:  
**C01**  
 Cross-references:  
**C02, B22, B24**  
 Appendixes:  
 /



Picture : S.Trachte

Current consumption of drinking water in Europe is 150 litres/day per capita on the average, but 55% of this consumption (cleaning, toilets, rinsing systems) do not require such high quality water.

Both the design of the distribution network and the equipment used can contribute to reducing consumption of drinking water:

- Designing and installing a quality water network
- Using systems that consume little water (appliances and faucets)
- Using another source of water when possible

It should also be noted that the occupants' behaviour plays a crucial role in potential reduction of consumption.

#### 1. DESIGNING AND BUILDING AN APPROPRIATE WATER NETWORK

A well-designed installation is an installation that:

- includes as short a distribution network as possible
- includes a minimum of «risky» elements such as bends, connections etc.
- can be easily located and is accessible to facilitate its management, maintenance and supervision
- does not alter the quality of the water

#### 1.1. Detecting leaks

On renovating housing and particularly on renovating large housing developments, it is crucial to be able to locate a leak very quickly, both in the collective distribution network and in the individual network for each dwelling.

Leaks that go undetected have a major impact on water consumption (see the table on this page).

Rapid detection of leaks requires:

- verifying the quality of the distribution network in terms of water tightness at the time of the renovation
- knowing the distribution network well as it was actually implemented on the construction site (using graphic plans)

##### - Verification of the distribution network – construction site

Before the beginning of work of restoration and at the end of the project, one will carry out, by setting under pressure of the distribution network, a checking of this one in order to:

- detect the possible escapes on the existing network before the renovation;
- check the repair of the possible leakage;
- check the defective implementations (new network or extension of the existing network) being able to cause leakage.

##### - Knowing the distribution network

Good knowledge of the distribution network is crucial in terms of managing, maintaining and supervising that network.

To achieve this, designers should obtain a plan of the distribution and evacuation networks as they were implemented in the construction or as they were put in/modified at the time of renovation.

These plans should contain the following information:

- location of distribution and evacuation columns
- stopcocks at the foot of the columns, numbered and labeled
- location of various sight holes
- location of various branches

Tap water consumption (average in Europe)	
Food	5% or 7.5 liters/day
Personnal hygiene	40% or 60 liters/day
Flush system (WC)	25% or 37.5 liters/day
Cleaning	10% or 15 liters/day
Washing	20% or 30 liters/day
<b>total</b>	<b>150 liters/day</b>

↑ Functions in red do not require the quality of tap water

Water leakages	Quantity wasted Average data given as an example
Dripping	4 liters/hour
Thin trickle of water	16 liters/hour
Trickle of water	63 liters/hour
Leaky toilet	25 liters/hour









Source : Fiche « faire un usage rationnel de l'eau » Guide pour la construction et rénovation de petits immeubles, IBGE, 2007.

## C. REDUCE THE TAPWATER CONSUMPTION

### Rational use of drinkable water

N° of Sheet:  
**C01**  
 Cross-references:  
**C02, B22, B24**  
 Appendixes:  
 /

#### 2. WATER SAVING SYSTEMS

Systems		Water savings	Other advantages	Change the habits
<b>Systems on distribution network</b>				
Leak detection		35 m <sup>3</sup> /year for a drip-drip		yes
Pressure reducing valve <i>A pressure reducer is a plumbing accessory that protects the water supply installation from excess pressure on the distribution network and minimizes noise caused by the flow of water in the pipes.</i>		2 to 10 liters/min for a tap according to the pressure	Increase the lifespan of the installation and devices	no
<b>Faucets and accessories</b>				
Dynamic flow reducer <i>This plumbing accessory is incorporated in the faucets and maintains the flow at a constant level independently of the pressure on the supply. It automatically compensates variations in pressure between 2 and 6 bars.</i>		55% for an economical shower	Energy saving on the hot water distribution-network	no
Thermostatic valve <i>The faucet regulates the temperature on one hand and the flow on the other; a temperature control faucet offers greater comfort to the user and reduces the risk of getting burned.</i>		65%	Energy saving on the hot water distribution-network	no
Mixing valve - cold in central position <i>A combination faucet that provides cold water when the knob is in the central position, rather than warm water as in a traditional system. Hot water is obtained by turning the knob to the left.</i>		20% compared to a standard mixing valve	Energy saving on the hot water distribution-network	no
<b>Flushing systems</b>				
Flush with 2 controls : 3 and 6 liters		53% compared to a flush of 9 liters	Less important dilution of pollution	yes
Flush with off-on switch		50% compared to a flush of 9 liters	Less important dilution of pollution	yes
Dry toilet		100% no use of water	Pas de rejet d'eaux vannes Engrais naturels après compostage	yes
<b>Devices</b>				
Shower in comparison with bath		50%	Energy saving on the hot water distributionnetwork	yes



C. REDUCE THE TAPWATER CONSUMPTION

Recovery and use of rain water

N° of Sheet:  
**C02**  
 Cross-references:  
**B22, C01, D01**  
 Appendix:  
**O1**

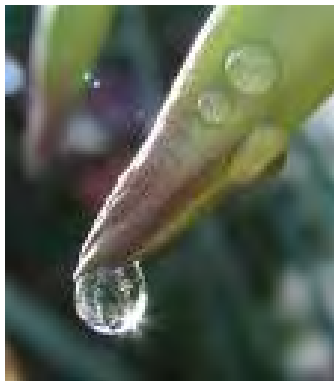

Current consumption of drinking water in Europe is 150 litres/day per capita on the average, but 55% of this consumption (cleaning, toilets, rinsing systems) do not require drinking water.

Where possible, rainwater should be used for the following purposes:

- supplying toilet flushes
- cleaning and laundry
- watering the garden

As a preventive measure, we recommend not using rainwater for food and hygiene.

*Picture : Sylvie Rouche*

1. PRINCIPLE

The rainwater on the roof is collected through the gutters and drainpipes. Then it flows through the first filter to eliminate dust and particles before being stored in a tank. A pump sends the stored water to the various appliances and faucets.

The rainwater cistern includes:

- an overflow system;
- a system for drinking water supply

The choice of the material of the cistern, its capacity, the choice of equipment and the area of the roofs to be connected to the cistern are elements that should be studied and assessed in view of the desired consumption of rainwater.

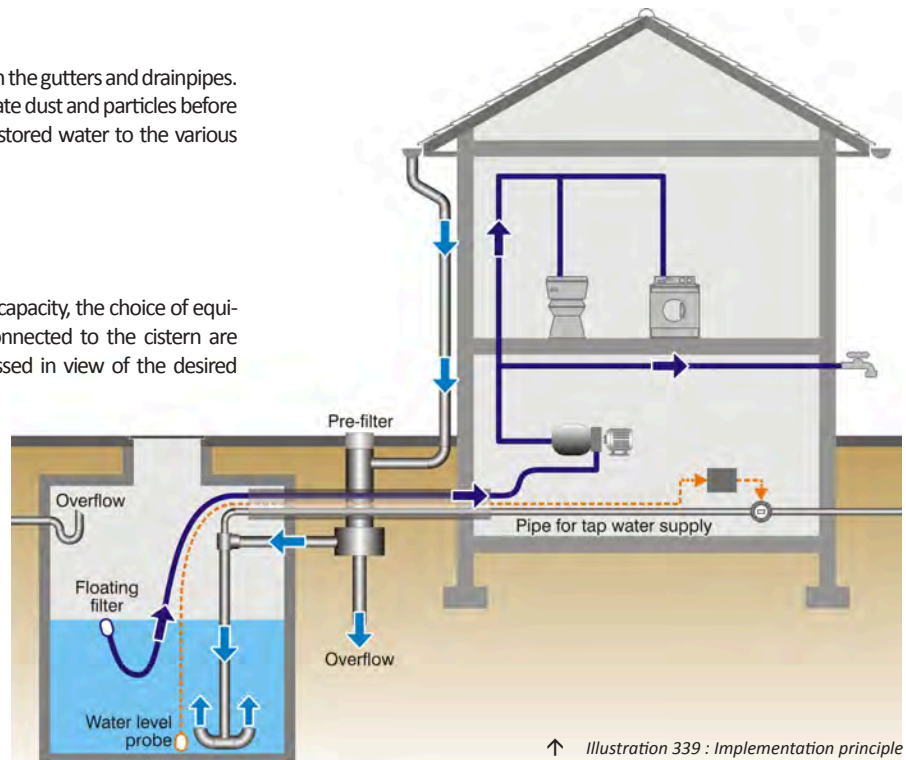

Tap water consumption (average in Europe)	
Food	5% or 7.5 liters/day
Personnal hygiene	40% or 60 liters/day
Flush system (WC)	25% or 37.5 liters/day
Cleaning	10% or 15 liters/day
Washing	20% or 30 liters/day
<b>total</b>	150 liters/day

↑ Functions in red could be supplied by rainwater



↑ Illustrations 340 and 341 : Funny watertank on roof - Brussel

## C. REDUCE THE TAPWATER CONSUMPTION

# Recovery and use of rain water

N° of Sheet:  
**C02**  
 Cross-references:  
**B22, C01, D01**  
 Appendix:  
**01**

### 2. FILTRATION OF RAINWATER

Thanks to the filtration systems, water of sufficiently high quality can be obtained to supply toilets, and for laundry and cleaning.

#### 2.1. Pre-filter

Before arriving in the storage cistern, the rainwater goes through an initial filtering system whose role is to eliminate and retain large particles (dust, pebbles, leaves, debris, ...) and thus to avoid accumulation in the cistern.

There are two types of filters: self-cleansing or non-self-cleansing.

Because regular maintenance is required, non-self-cleansing filters are not recommended.

Self-cleansing filters require no maintenance; they consist of a fine stainless steel filter and two evacuations: one for filtered water leading to the cistern, and the other for the particles retained plus about 10% of the quantity of water.

#### 2.2. Post-filter

To prevent any clogging (suspended particles), a second filter is mounted where the water is taken into the cistern. This filter is placed on the suction pipe.

### 3. RAINWATER TANK

#### 3.1. Size of the tank

*An indicative calculation of dimensioning is given in appendix 01.*

The size of the rainwater tank should be determined so as to meet maximum needs (80 to 90%). To achieve this, it is important to know the collection area, weather data, and average consumption of drinking water.

#### 3.2. Rainwater tank materials

Two types of materials are available for storage tanks:

Concrete tanks	Plastic tank
Heavy material.	Lightweight material
Hard to install in the event of renovation (requires a crane).	Easy to install
The walls and the bottom must be made in a single piece.	If the tank is underground, ballast is required.
No ballast required	A layer of gravel and a layer of limestone must be provided.
Concrete has the advantage of having a high mineral content that allows for the development of micro-organisms (natural purification of water) and neutralizing of the natural acidity in rainwater.	The layer of gravel and the layer of limestone enable micro-organisms to develop (natural purification of water) and neutralize the natural acidity in rainwater. In addition, they act as ballast for the tank.

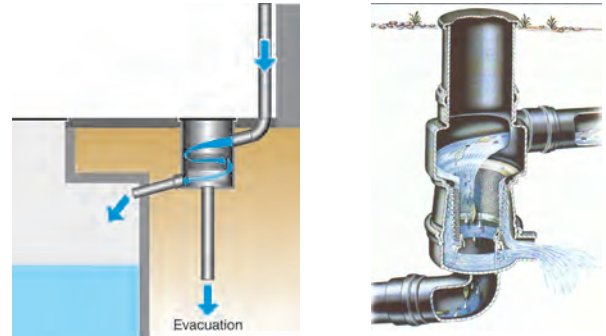

↑ Illustrations 342 and 343 : Cyclon filter - Self-cleaning filter

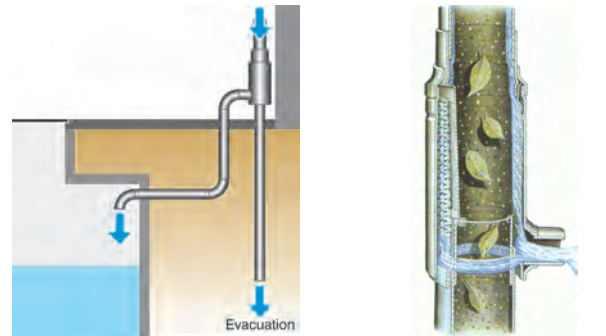

↑ Illustrations 344 and 345 : Self-cleaning filter



↑ Illustration 346: Plastic water tank



↑ Illustration 347 : Concrete water tank



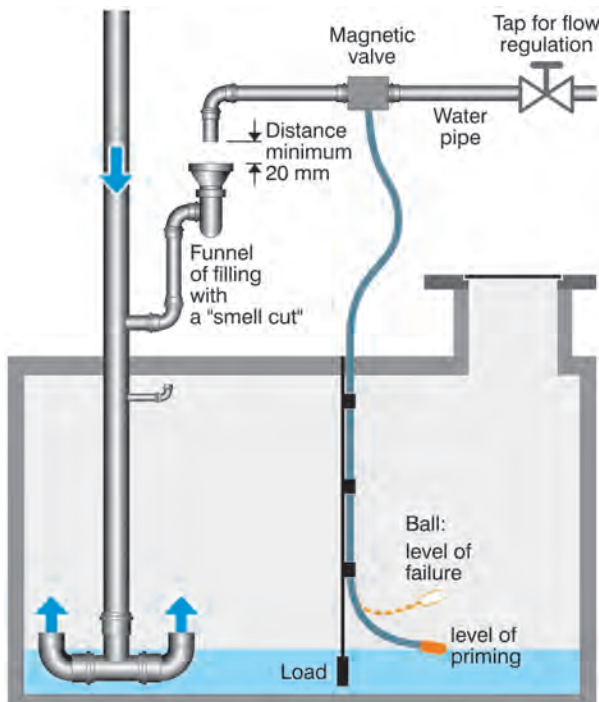

↑ Illustration 348 : Diagram explaining tank installation

### 3.3. Planting and accessories

#### - Installation

The tank must necessarily be protected from light, heat and freezing. Preferably, it should be buried but if applicable, it could be put in a basement or attic if the floors are sufficiently resistant.

The tank should be accessible (cleaning):

- the cover of the supply pipe should be free from any vegetation or deposit;
- the opening should be sufficiently large to allow a person to go into the tank;
- the floor of the tank should be sufficiently strong to bear the weight of a ladder with a person on it.

In urban areas, the tank should be divided into two compartments, for the sake of maintenance and the filters:

- the first compartment should be used as a settling tank, with a capacity of 10 to 20% of the capacity of the second compartment; the overflow from the settling tank should supply the second compartment;
- the second compartment serves as the tank from which water is drawn.

#### - Arrival of water (in the tank)

The arrival of rainwater in the tank should correspond to the diagram below.

This system prevents turbulence at the bottom of the tank where sludge deposits are formed.

#### - Drinking water supply (in case of dryness)

In the case of a long drought, the rainwater tank can empty completely or almost completely, so a supply of drinking water is needed.

A fixed connection between the two networks is not authorized, so they must be completely separated.

This can be done either manually or automatically:

#### - manually

The tank can be filled by a garden hose or a continual filling system (filling corresponding to estimated consumption before the next rainfall).

#### - automatically

A pump floater triggers the drinking water supply faucet when it reaches a low point; this fills the tank with enough drinking water for specific needs for one day.

#### - Overflow system

The rainwater tank should be equipped with an overflow system. This will only be operational about 10 times a year (depending on the size of the tank).

In terms of sustainable development, it is recommended to connect the overflow to a system for infiltration in the soil, such as a diffusion well, ditch or pond so that excess rainwater seeps into the water table.

When this solution cannot be envisaged due to technical or economic reasons, the overflow should be connected to a collective network, with certain precautions in view of the characteristics of the network (check valve, siphon-shaped entrance to the overflow, ...)

**4. PUMP SYSTEM**

**4.1. The pump**

There are different kinds of pumps, each of which has its advantages and disadvantages.

To make a comparison between the various pumps, the following features should be checked:

- energy consumption
- presence or absence of a run-dry safety device
- sound level of the pump
- corrosion resistant materials
- automatic triggering and suction height
- power and pressure buildup

**4.2. Suction pipe**

The suction pipe to the pump should be located:

- at a certain height above the bottom of the tank to prevent suction of sludge;
- sufficiently below the level of the water surface to prevent suction of air.

The best system consists of fixing the suction pipe to a float device so that suction of the water always takes place about 10 cm below the water surface (see illustration 348).

This system consists of a float, a filter (post-filter) and a foot valve that prevents the suction pipe from operating.

To prevent the pump from continuing to operate when the tank is dry, the system should have a run-dry safety device. The type of device depends on the type of pump installed.

**5. DISTRIBUTION SYSTEM**

**5.1. Supply pipes**

As rainwater is very soft water, it can be corrosive for certain materials used for water supply pipes. Consequently, the pipes should be made from either plastic or stainless steel.

**5.2. Collection points**

All collection points for rainwater should be identified by a label stating «unfit for drinking ». Outdoor faucets (for watering the garden) should preferably be installed out of reach of children or be equipped with a safety device.

**6. MAINTENANCE**

**6.1. Maintenance of the filters**

The filters should be maintained once a year.

**6.2. Maintenance of the tank**

A correctly installed tank should be cleaned every 10 years. Cleaning of the tank consists of eliminating the sludge that has accumulated in the bottom. In the case of a cistern with two tanks, only the settling tank needs cleaning. Cleaning the walls on which micro-organisms have developed over the years is NOT recommended; only sludge should be removed from the bottom of the tank.

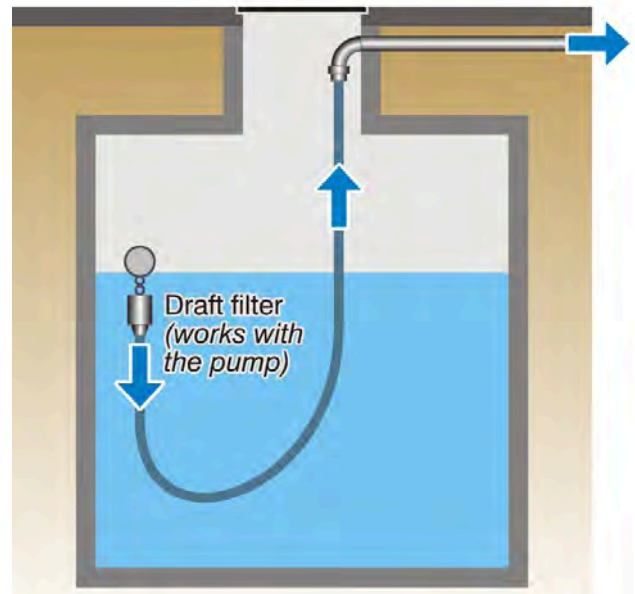

↑ Illustration 349 : Immersed pump and suction pipe



↑ Illustration 350 : Immersed pump



↑ Illustration 351 : Immersed pump



↑ Illustration 352 : Centrifugal pump



↑ Illustration 353 : Pump installation

## D. INCREASE THE WATER RESOURCES



D01 - Rainwater management on the parcel

D02 - Water recycling by plants - extensive systems

D03 - Water recycling in urban area - intensive systems

*Picture from Valérie Mahaut*





## D. INCREASE THE WATER RESOURCES

# Rainwater management on the parcel

N° of Sheet:  
**D01**  
 Cross-references:  
**A12, C02, D02**  
 Appendix:  
 /

«Rainwater management on a lot targets compensating the impermeabilization of soils inherent to constructions and landscaping of the grounds around them. Its objective is to reduce runoff and to lighten the load on the existing collective drainage infrastructures. It contributes to preventing floods and pollution of groundwater, and to supplying the water table»

Source: *Guide pratique à la construction et rénovation durable de petits bâtiments*, IBGE, 2007

Several measures with proven effectiveness can be rapidly and easily put in place:

- favouring the creation of green areas, particularly in the courtyards of buildings and inside city blocks;
- increasing permeability of gray areas (terraces, paths, parking lots);
- favouring vegetation on roofs (that act as a storm water tank)

### 1. HELPFUL INDICATORS FOR MANAGING RAINWATER

#### 1.1. Impermeabilization coefficient

The impermeabilization coefficient is the ratio between the impermeable surface area and the total surface area of a lot. On renovating the lot, the author of the project should take care to keep this impermeabilization coefficient between 0.4 and 0.2.

Performance table

Classical	Performant	High performant
80 to 40%	40 to 20%	< 20%

Source : «Qualité environnementale des bâtiments», Ademe

#### 1.2. Infiltration coefficient of the soil

The infiltration coefficient of the soil corresponds to its permeability.

Some examples:

Type of ground	Infiltration capacity mm/h
Sand with coarse-grained	500
Fine sand	20
Fine silty sand	11
Thin gravel	10
Peat	2.2
Silt	2.1
Light clay	1.5
Fairly heavy clay	0.5
Clay silt	0.4

Source : «Waterwegwijzer voor architecten», VMM, 2000

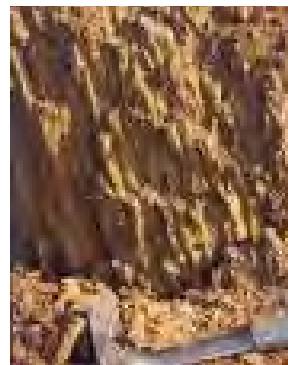

↑ Illustration 354 : Clay



↑ Illustration 355 : Gravel



↑ Illustration 356 : Grass

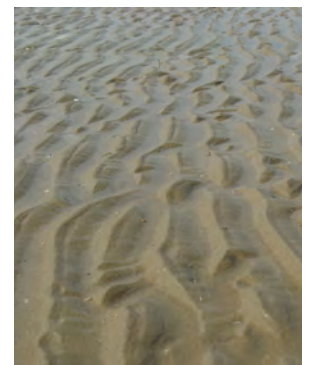

↑ Illustration 357 : Fine sand

# Rainwater management on the parcel

## 2. VEGETATION TO BE PLANTED ON THE LOT

On renovating the grounds (around the housing to be renovated), certain measures using plants can help retention and infiltration of rainwater:

### 2.1. Measures using plants for retention and infiltration

#### - Infiltration basins

These are natural systems that can be integrated in the landscaping of large and medium-sized collective housing units. They are open air facilities designed to temporarily store runoff water and infiltrate it in the soil, so consequently the water is present only temporarily.

On the scale of a lot, infiltration basins can take different forms:

- A dry basin that has been planted
- A grassy hollow
- A dip or ditch (planted or no)

#### - Basin or pond

These are permanent bodies of water for rainwater and runoff collected during rainfall. The size of the body of water varies with its utility and the volume of retention needed: from a little pond at the bottom of the garden to a lake for water sports. The system is a natural one that can be integrated in the landscaping for large and medium-sized collective housing developments or in the yard of an individual home.

It has many advantages:

- little maintenance is needed
- depollution of rainwater (phyto-purification)
- very good integration in the landscape
- creation of ecosystems

#### - Hedge separating neighbouring gardens

On a smaller scale, hedges between neighbouring gardens also favour infiltration and retention of rainwater and runoff.

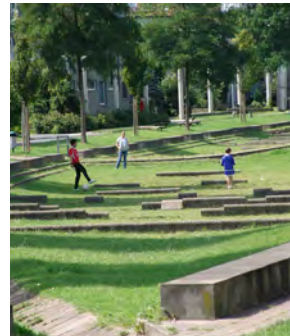

↑ Illustrations 358 and 359 : Infiltration basin



↑ Illustration 360 : Little basin in gardens



↑ Illustration 361 : Hedge and various coverings to infiltrate rainwater



↑ Illustrations 362 and 363 : Water channels



← Illustrations 364 : Green roof - extensive vegetation

### 2.2. Plant schemes for retaining and collecting water

#### - Gutters and canals

These natural systems can be integrated into the grounds of large and medium-sized collective housing developments as a separating element (private property and public property) and for landscaping. Wide, flat open-air canals with a slight slope can carry water instead of underground pipes so the path taken by water is made visible and accessible.

#### - Green roof

A green roof is also an important element for managing rainwater on a lot because it acts as a storm tank and consequently, in the case of heavy rain, it lightens the load on the sewer system by providing temporary storage and deferred, progressive draining.

The various types of green roofs are described in sheet A12

## Rainwater management on the parcel

## 3. GROUND COVER MATERIALS

On renovating the grounds (around housing to be renovated), the designer should give priority to the use of permeable materials for access paths and parking places.

Type of covering	Pictures / Schémas	Description
Gravel		Ground cover consisting of natural pebbles or rolled gravel. The thickness of the layer and its granulometry depend on the load to be carried. Simple to implement and inexpensive. Cannot bear intensive traffic.
Dolomite		Ground cover consisting of a mixture of dolomite with a coarse granulometry, cement, mixing water and lime. This geotextile prevents the layers from combining and also presents the appearance of plants or grass. Cannot bear frequent automobile traffic.
Pavement with wide joints		Concrete or natural stone pavement with wide joints (2 to 3.5 cm), the joints are filled with fine gravel or coarse sand. Permeability decreases if plants grow in the joints.
Permeable pavement		Perforated concrete paving stones with small water evacuation channels on the underside.
Grass + concrete flagstones		Hollow concrete pavement stones filled with peat and grass seed. The pavement stones are installed over a sub-layer and a gravel foundation. Depending on the model, the pavement stones grow grass on 35 to 65 % of the surface area. Pavement stones adapted for automobile traffic and car parks. Regular maintenance of the grass (fertilizer, cutting etc.) is needed.
Polyethylene grass flagstones		Blocks made from high density recycled polyethylene. When assembled, they make a honeycomb layer that is filled with gravel or peat and grass seed. Lightweight, sturdy systems – easy to install







## D. INCREASE THE WATER RESOURCES

# Lagunage: water recycling by plants system

N° of Sheet:  
**D02**  
Cross-references:  
**D01, C01**  
Appendix:  
/

Preserving our water resources also means:

- limiting pollution in waste water that goes down the drain
- depolluting waste water before re-infiltrating it in the soil (the polluter pays principle)

There are different individual purification techniques for waste water:

- *intensive systems*: purification of waste water by oxygenation and mechanical intervention
- *extensive systems*: purification of waste water by natural treatment without mechanical intervention

We will talk only about the so-called extensive systems here because they are as effective and adapted as the intensive systems and they have economic and ecological advantages, since they contribute to improving ecosystems and landscaping of outdoor areas, while making users responsible for their own water consumption and detergent or cleansing products (pollutants).

### 1. BASIC CONCEPT

#### 1.1. Definition

Lagooning or purification by plants is a purification technique based on the transformation and assimilation of household pollutants by the aquatic food chain.

This technique allows both for organic depollution and microbial decontamination thanks to:

- slow, gradual outflow of waste water into successive basins;
- a biological combination covering an entire food chain (aerobic bacteria, anaerobic bacteria, algae and phytoplankton)

Lagooning treats waste water exclusively. Rainwater is excluded from the purification system. Waste water consists of:

#### - black water or domestic sewage

Water loaded with organic material such as proteins, fats and sugars. These matters are not naturally toxic, they are only pollutants because of the place where they are pumped out (too often in streams and rivers).

#### - Gray water (kitchen, bathroom and wash-house)

This water represents 70% of the volume of water consumed and contains tensio-active elements (\*) and phosphates (\*\*) contained in detergents and cleansing products.

↓ Illustrations 365 and 366: Various basins for water purification

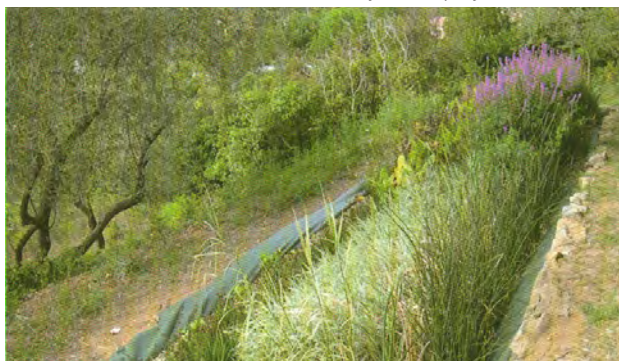

#### 1.2. Quantity and pollution of worn water

The quantity of waste water is about 120 to 150 litres per occupant.

For this volume of water, average pollution is as follows:

Type of pollutants	Quantity	Health or environmental risk
Pathogenic micro-organisms	Many billions/100ml of waste water	Diseases
Suspended matters(SM)	50 to 70gr 420mg/liter	Eutrophization of groundwater
COD (chemical oxygen demand)	115 to 140 gr 950mg/liter	
BOD (biochemical oxygen demand)	60 to 75 gr 500mg/liter	Organic pollution of water
Nitrogenous matters	14 to 18 gr 120mg/liter	Eutrophization of groundwater
Phosphorous matters	4 to 5gr 30mg/liter	Eutrophization of groundwater

Source : « *L'épuration naturelle par LAGUNAGE, agencement de systèmes aquatiques reconstitués* – Ch.Heyden – 2004 » et « *Fosse septique, roseaux, bambous ? Traiter écologiquement ses eaux usées* – S.Cabrit-Leclerc – Terre Vivante, 2008 »

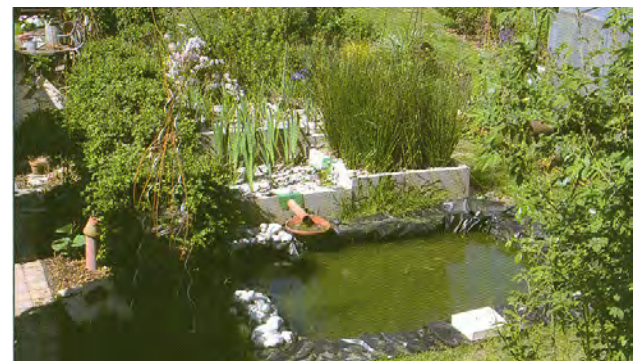

## D. INCREASE THE WATER RESOURCES

# Lagunage: water recycling by plants system

N° of Sheet:  
**D02**  
 Cross-references:  
**D01, C01**  
 Appendix:  
 /

### 2. TYPE OF BASINS

#### 2.1. Reeds on gravel bed

Area: 4 to 5 m<sup>2</sup>/user  
 Depth of water: 60 cm  
 Substrate: grit, caliber 7-14 mm  
 Depth of substrate: 70 cm  
 Plants: reeds, swamp iris, rattan, burr-reed, ...

The entire basin is filled with grit so that the water is at least 5 cm deep under the substrate level. Through-flow is horizontal. Reeds should occupy ¾ of the surface upstream of the lagoon, the ¼ downstream should be planted with another species.

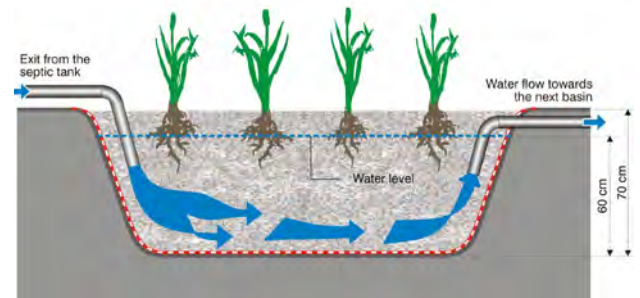

↑ Illustration 367 : Roselière on gravel bed

#### 2.2. Sand filter planted with reeds

Area: 2.5 m<sup>2</sup>/user  
 Depth of water: /  
 Substrate: earth, river sand, ballast 20-40 mm. Substrates used in successive layers of different thicknesses  
 Depth of substrate: 150 cm  
 Plants: reeds

A sand filter planted with reeds in which water flows vertically from top to bottom can only be set up on a terrain that has a minimum grade of 1.5 m.

The reeds prevent the filter from clogging, provide oxygen for the biomass and contribute to purification by absorbing nitrogen and phosphorus.

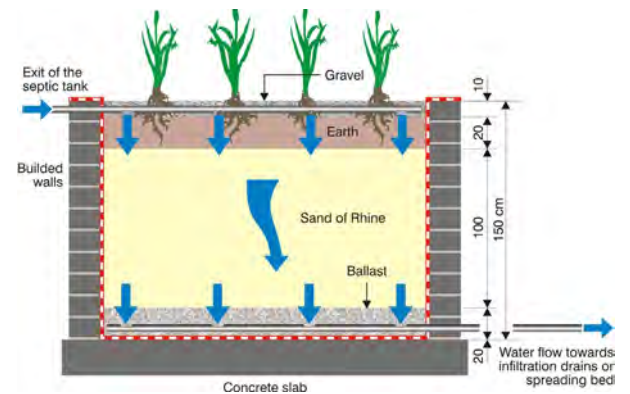

↑ Illustration 368 : Sand filter planted with reeds

#### 2.3. Reconstituted wetland

Area: 3 to 4 m<sup>2</sup>/user  
 Substrate: earth, grit and Rhine sand  
 Depth of substrate: 60 cm

Requires a buffer zone of 1.5 m<sup>3</sup> (without substrate — depth of water 60 cm)

The lagoon itself is filled with substrate, no water is visible. Evacuation takes place at the lower level of the lagoon

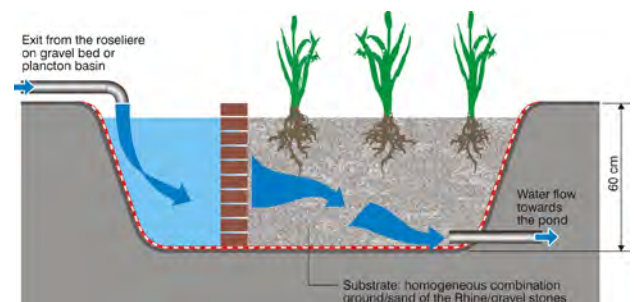

↑ Illustration 369 : Reconstituted wetland

#### 2.4. Microphyte lagoon

Area: 2 m<sup>2</sup>/user  
 Depth of water: 60 cm  
 Substrate: clay soil from dredging  
 Depth of substrate: 75 cm

The lagoon is not planted; it is reserved for the development of plankton. Integration of this type of pool in the purification line creates a «pond» ecosystem by recovering the purified water and storing it to be used to water the garden.

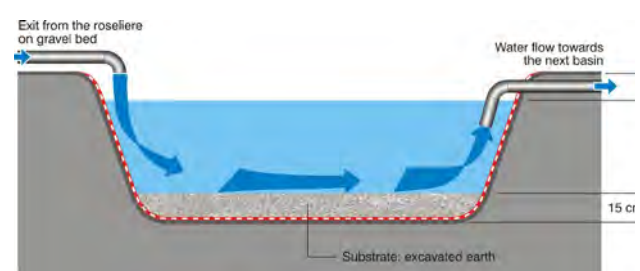

↑ Illustration 370 : Plankton basin



↑ Illustration 371 : Two basins in parallel with a vertical flow

### 3. TYPES OF PURIFICATION SCHEMES

There are different lagoon purification schemes (several basins in succession). The choice of the scheme will depend on:

- the available area on the lot
- the morphology of the lot
- the number of occupants

There are two types of schemes:

#### - *Single basin schemes*

These are composed of a single basin with vertical or horizontal through-flow.

The purified water must necessarily be evacuated in the soil where it will get additional purification (nitrates and phosphates).

#### - *Multi-basin schemes*

Systems made up of two or three basins:

- Horizontal through-flow basin
- Reconstituted wetland

or

- Horizontal through-flow basin
- Microphyte lagoon
- Reconstituted wetland

### 4. LAGOONING INSTALLATION

#### 4.1. A few recommendations

##### - *Preprocessing of waste water*

The waste water must be pretreated before being forwarded to the purification basins:

- black water is pretreated in a septic tank
- gray water is pretreated in a grease removal tank

##### - *Retention time of water to be purified*

The retention time of water to be purified in the lagooning basins must be more than 30 days. This corresponds to a total area of a body of water of about 5 m<sup>2</sup> per user.

##### - *Watertightness of the basins*

The purification basins must necessarily be watertight to avoid any pollution of the ground water. Moreover, if the basins are not sufficiently watertight, they will probably never fill with water and consequently they will not fulfil their cleansing role correctly.

##### - *The quality of the substrate*

The substrate in which the aquatic plants are rooted must provide:

- good water run-off
- good contact between the water to be purified and the roots of the aquatic plants
- fixing of micro-organisms (plankton, bacteria, rotatoria, ...)

##### - *The flow and drainage of purified water*

Care must be taken to ensure correct through-flow of the water between the various basins. The pipes should be insulated during freezing weather. Drainage of the purified water is done through the soil, via:

- an underground drainage bed;
- a ditch;
- a stream when it is not possible to use one of the first two processes.



↑ Illustration 372 : Installation of gravel layer



↑ Illustration 373 : Various plants for the purification process





## D. INCREASE THE WATER RESOURCES

# Water recycling in urban area: intensive systems

N° of Sheet:  
**D03**  
 Cross-references:  
**C01, D01, D02**  
 Appendix:  
 /

Instead of draining waste water directly into the sewers, it could easily be treated for reuse, particularly for maintenance, watering and toilets. This would save about 55% of drinking water.

In a dense urban environment, it is not always easy to install lagooning, essentially because of the lack of room. In this case a so-called «intensive» system can be installed for recycling waste water.

The techniques presented below are techniques commonly used for the purification of urban waste water, in collective or individual dwellings.

### 1. BASIC CONCEPT

#### 1.1. Individual pretreatment of waste water

Treatment of waste water can be subdivided into three phases: pretreatment or primary purification, biological or secondary purification, and third stage purification.

There are various possibilities for each of the three phases.

#### 1.2. Principle of biological purification in micro-stations

After settling in a first tank, the waste water flows into a second tank where biological purification takes place.

The bacteria present in the waste water disintegrate the organic particles and possibly nitrogen and phosphorus. The elimination of nitrogen and phosphorus is called elimination of nutrients; it is achieved by a combination of purification in an oxygen-rich environment and an oxygen-poor environment.

The bacteria are fixed to a medium that can be immersed or suspended, such as flakes in the water. After a certain time, the bacteria reproduce to the point where they slough off in the form of flakes. These are separated from the water in the third tank, which acts as a second settling basin, and are sent to a storage tank (which by and large is the first settling tank that has been pumped out). The purified water can then be drained into a ditch or a stream.

#### 1.2. Quantity and pollution of worn water

The quantity of waste water is about 120 to 150 litres per occupant.

For this volume of water, average pollution is as follows:

Type of pollutants	Quantity	Health or environmental risk
Pathogenic micro-organisms	Many billions/100ml of waste water	Diseases
Suspended matters (SM)	50 to 70gr 420mg/liter	Eutrophization of groundwater
COD (chemical oxygen demand)	115 to 140 gr 950mg/liter	
BOD (biochemical oxygen demand)	60 to 75 gr 500mg/liter	Organic pollution of water
Nitrogenous matters	14 to 18 gr 120mg/liter	Eutrophization of groundwater
Phosphorous matters	4 to 5gr 30mg/liter	Eutrophization of groundwater

Source : « *L'épuration naturelle par LAGUNAGE, agencement de systèmes aquatiques reconstitués – Ch. Heyden – 2004* » et « *Fosse septique, roseaux, bambous ? Traiter écologiquement ses eaux usées – S. Cabrit-Leclerc – Terre Vivante, 2008* »

Pretreatment or primary purification	Biological purification		Thirth purification
Settling tank Degraisseur Septic tank	Micro-stations	Biological disks	Secondary settling tank Clarification tank
		Aerobic bacterial bed	
		Activated sludges	
		Fixed biomass	
	Purification by plants	see sheet D02	

**2. PRE-TREATMENT OR PRIMARY PURIFICATION**

This text comes, for the majority from two sources: «Guide pratique pour la construction et rénovation durable de petits bâtiments», IBGE, Bruxelles, 2006 and « Waterwegwijzer voor architecten» Vlaams Milieu Maatschappij.

**2.1. Screening**

This is done in a reception chamber equipped with one or several grids of varying coarseness to retain different size objects. The purpose of screening is to prevent the passage of «coarse» bodies into the pipes and connecting tubes to prevent them from clogging the pipes or disturbing the treatment in the network downstream.

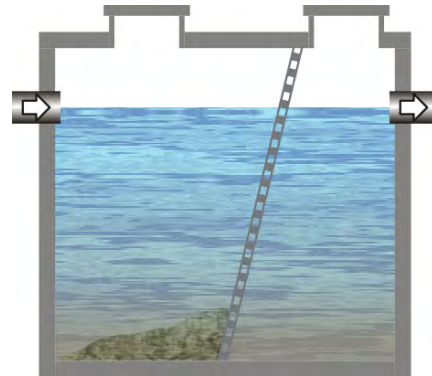

↑ Illustration 374 : Particles separation

**2.2. Settling tank**

This tank operates according to the settling principle: the weight of the heavier suspended particles drags them to the bottom of the tank.

To operate well, the water must be as still as possible. The decanted water at the top gets further treatment in a second tank. The sludge at the bottom of the tank is removed regularly: the tank is cleaned and the sludge removed by a tank truck. This operation is necessary to prevent any risk of clogging the pipes.

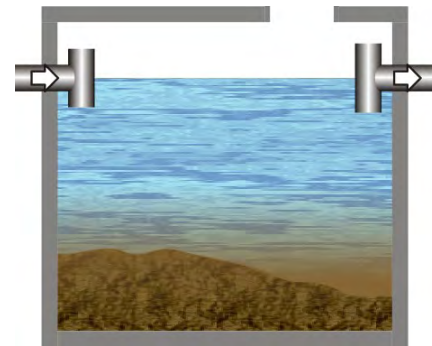

↑ Illustration 375 : Sedimentation tank

**2.3. Grease removal tank**

This system is installed on the network for draining waste water from the kitchen, as close to the source as possible.

Particles of grease and oil are lighter than water and rise to the surface where they are removed. The system requires regular maintenance.

**2.4. Septic tank**

This pre-treatment is intended to initiate the purifying process and to reduce the organic load and suspended matters in waste water:

- Physical action of settling and floating of suspended matters;
- Biological action that consists of the digestion of the polluting load by micro-organisms

The septic tank must be emptied regularly every 2 or 3 years. It must never be emptied totally, however: about 20% of the sludge should be maintained to trigger the continued action. Rainwater or run-off from roofs or other surfaces must never flow into a septic tank.

A septic tank traditionally receives water from the toilets only, but it can also pre-treat grey water from the kitchen (after it has first gone through grease removal) and the bathroom:

- Effectiveness of a septic tank (black water and grey water): 30% of the organic load
- Effectiveness of a septic tank (pre-treated grey water): 60 to 80% of the organic load

The tanks can be made from concrete or a synthetic material. Particular care must be taken to ensure resistance of the walls that could deteriorate due to the corrosive action of fermentation gases.

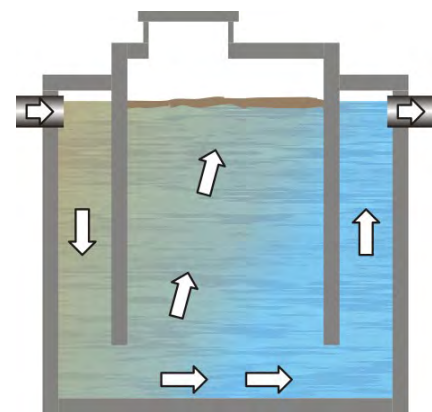

↑ Illustration 376 : Grease remover

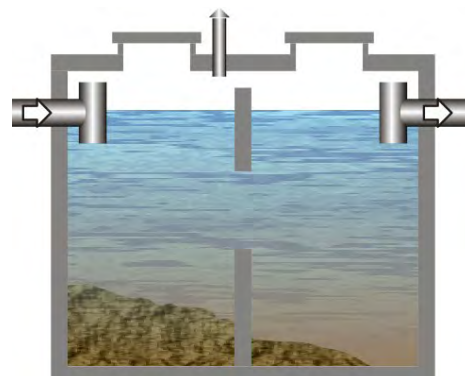

↑ Illustration 377 : Septic tank

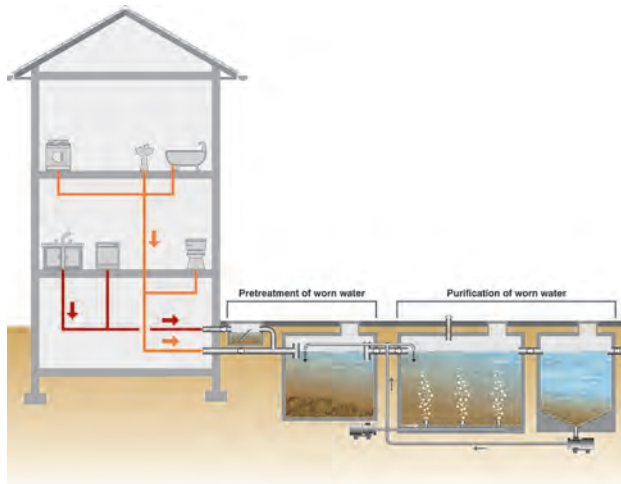

↑ Illustration 378 : Working of the system

### 3. STORAGE AND DISTRIBUTION OF WATER

Waste water, once it has been treated, must be stored before being redistributed for the various functions it performs. Maintenance of the quality of the water after purification depends essentially on the effectiveness of the purification process: effective reduction of the organic load, nitrogenous and phosphorous pollution and bacteria, etc.

There are techniques to maintain the quality of water during storage but these are expensive, energy consuming and/or polluting:

- techniques to oxygenize water to avoid anaerobic fermentation
- disinfection techniques (ultrasound, UV rays, inverse osmosis, ...)

#### 3.1. Characteristics and features of the tank

##### - Tank

The tank and the purified water distribution network are similar to the tank and distribution network for rainwater (see information sheet C02).

After the waste water has been treated it should be stored in a watertight tank equipped with a sump, a level gauge or a level probe and a system for adding a supply of drinking water (disconnected from the purified water).

The tank should be accessible for maintenance:

- the cover of the supply pipe should be free of any plants or deposits;
- there should be an opening sufficiently large to let a man go down into the tank.

The tank should be made from concrete or synthetic materials. The tank should also be equipped with an overflow system. This overflow system should have a siphon and possibly a check valve to prevent propagation of bad odours. The overflow is evacuated to the collective sewer system or a temporary storage tank (reserve tank in case of maintenance or repair).

##### - Distribution network

The distribution networks carrying drinking water and purified water should be clearly identified and differentiated. With this in mind, signs should be put in, including:

- an installation diagram identifying the various components;
- marking and identification of the distribution pipes for the two water networks;
- signs and labels stating «unfit for drinking» wherever water is drawn.

Outdoor faucets should be kept out of the reach of children or equipped with a safety device.

A by-pass on the pipe carrying water after purification can be connected to the sewer network to prevent any further pollution if the purifying process is not working properly.

#### 3.2. Maintenance of the tank

The tank should be maintained regularly: cleaning and disinfection should be done at least once a year and after any event that could alter the quality of the water in storage.

The tank is emptied by a vacuum pump into a tank truck and cleaning is done by a high pressure cleaner and scrub brushes for the inside walls.

# Water recycling by intensive systems

N° of Sheet:  
**D03**  
 Cross-references:  
**C01, D01, D02**  
 Appendix:  
 /

## 4. INTENSIVE TECHNIQUES FOR PURIFICATION OF WASTE WATER

### 4.1. Preliminary comment

The so-called «intensive» techniques are not the most effective techniques in all cases of purification.

In fact:

- their effectiveness is limited as concerns nitrogenous / phosphorus pollution and bacteriological pollution;
- these techniques require more energy than the so-called «extensive» techniques (due to the use of pumps, aerators and so on)
- their maintenance requires skilled labour

Because of the reasons referred to above, these techniques will be described only briefly.

### 4.2. Various systems

#### - Rotating biological contactor

Rotating biological contactors are used for an aerobic biological treatment process with a fixed biomass.

The biological contactors use the principle of transformation and destruction of organic matters by fixed micro-organisms.

The micro-organisms are fixed on contactors partially immersed in the effluent to be treated; these rotate to ensure effective mixture (effluent and micro-organisms) and oxidization of the micro-organisms.

The cultures of micro-organisms form a «biofilm» or purifying biological film on the collector surface.

The effluent is settled first, to prevent clogging the collectors. The sludge that flakes off is separated from the treated water by clarification.

The biological contactor unit consists of discs mounted on a shaft in an open air basin filled with waste water. The discs turn slowly in the basin – when they go through the waste water, the organic materials are absorbed by the biofilm fixed on the contactor. The discs thicken as a layer of sludge is formed on them due to accumulation of biological matter.

Oxygen is absorbed when the discs pass through open air, which promotes growth of the biomass.

After the biomass has absorbed the organic materials, it degrades them by aerobic fermentation thanks to the presence of oxygen.

#### - The aerobic bacterial bed

An aerobic biological filter is an aerobic, fixed-culture biological treatment process. Micro-organisms develop on the collector placed above the level of the effluent to be treated, but regularly washed by it.

The collector consists of a filter made from porous or cavernous material: volcanic stone, gravel, synthetic materials etc. on which the micro-organisms form a biofilm or biological film that can assimilate the pollution. The filter is constantly aired naturally or mechanically.

The water to be treated is dispersed on the upper part of the filter using a sprinkler system. It then trickles through the filter. The pollutants are absorbed by the biological film made up of aerobic bacteria on the surface and anaerobic bacteria under the surface.

The biological film essentially consists of bacteria, but it also hosts other more or less complex organisms integrated in the food chain (protozoans, insects, ...).

The byproducts and carbon dioxide normally produced by the

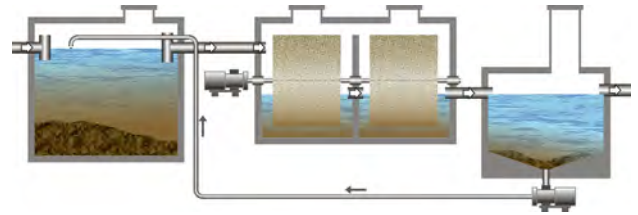

↑ Illustration 379 : The water purification by biological discs

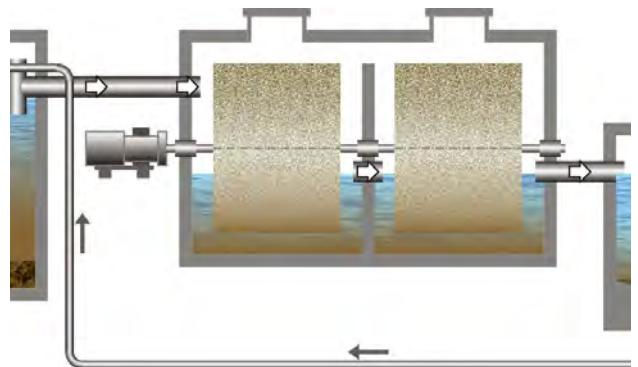

↑ Illustration 380 : The biological discs

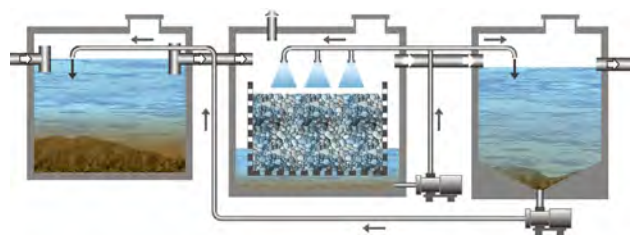

↑ Illustration 381 : The water purification by aerobic bacterial bed

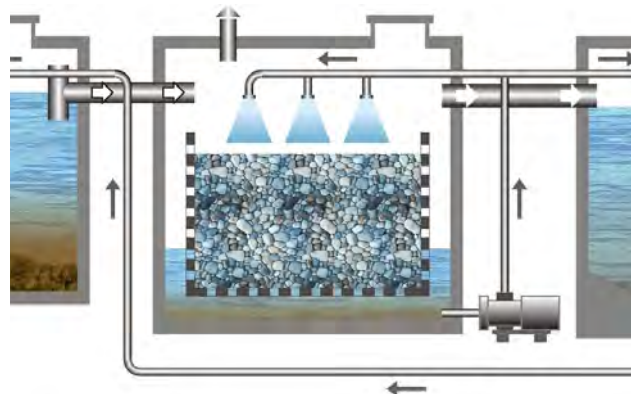

↑ Illustration 382 : The aerobic bacterial bed



# Water recycling by intensive systems

N° of Sheet:  
**D03**  
 Cross-references:  
**C01, D01, D02**  
 Appendix:  
 /

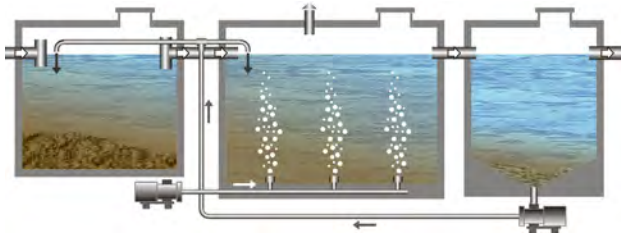

↑ Illustration 383 : The water purification by activated sludge

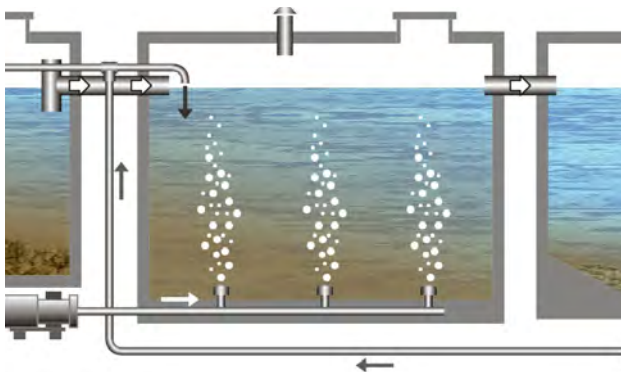

↑ Illustration 384 : The activated sludge

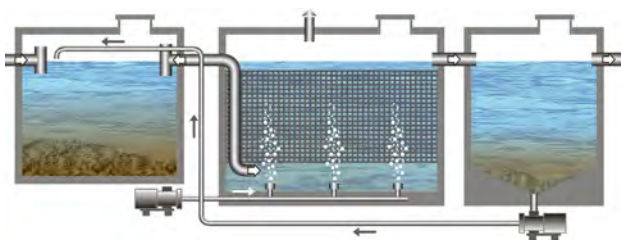

↑ Illustration 385 : The water purification by aerobic immersed biomass

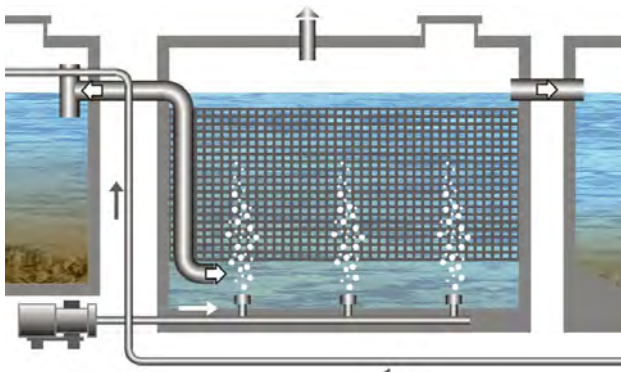

↑ Illustration 386 : The aerobic immersed biomass

purification process are evacuated in the liquid or gaseous fluids.

Surplus sludge naturally falls off the collector due to water pressure as the biological film thickens. The sludge is separated from the effluent by secondary settling (combined decanting-digesting).

*Note:*

*The effectiveness of the system drops significantly when the outdoor temperature falls below 5°C.*

### - Activated sludge

Activated sludge is an aerobic, open-air culture biological treatment process.

In this treatment process, micro-organisms develop in a basin fed by the waste water to be treated on one hand and on the other by oxygen via an air supply. The micro-organisms suspended in the water in the basin are continually in contact with the polluting matters on which they feed, and with the oxygen needed for their assimilation.

Considerable aeration is needed (major energy consumption) to allow the activity of the bacteria and the deterioration of the polluting matters.

This process is used for three specific purposes:

- Eliminating carbonous (organic) matters
- Eliminating nitrogenous pollution
- Eliminating phosphorus biologically

### - Aerobic immersed biomass process

The aerobic immersed biomass process is a fixed-culture biological treatment.

Micro-organisms are fixed on a collector totally immersed in the waste water and/or float on flakes. Aeration elements under the medium provide oxygen.

The micro-organisms feed partially on nutrients (nitrogen, phosphorus) contained in the waste water and use the carbon in the organic materials to synthesize their own matter. From this they can draw the energy they need to survive. Dead micro-organisms form flakes that settle out (in the form of sludge) at the bottom of the tank.

## 5. SELECTIVE TREATMENT OF GRAY WATER

Unlike the processes presented above, these processes can be used only for purification of grey water.

### - WATER CONVERT system – recycling in cascade of gray water

A system for recovering gray water from the shower and the bath to rinse the toilet bowl, that can easily be installed when renovating an individual dwelling.

The gray water from the bath or the shower is recovered in a small tank placed alongside the tub. This tank contains a mechanical filter (with a bactericide additive) at the pump. The tank is also equipped with an overflow connected to the sewer system.

The water is automatically treated with a bactericide solution in the tank that is dosed suitably, coloured blue, and scented. The solution contains lime scale prevention agents. It does not jeopardize operations in waste water treatment stations.

## Water recycling by intensive systems

The pump sends the gray water to the storage tank behind the toilet. If there is not enough gray water, the tank is supplied with municipal water.

The entire system is managed electronically.

### - PONTOS AQUACYCLE system ([www.pontos-aquacycle.de](http://www.pontos-aquacycle.de))

This is a German system for recovering gray water from the shower and the bath and using it to rinse the toilet bowl (collective and/or individual dwellings). The system takes up a lot of room and ideally should be put in the cellar.

The system includes the following elements:

- polyethylene pre-treatment tank that is watertight and does not allow odours to escape, for the aerobic biological treatment of gray water. This unit consists of a fluidized bed that can fix the biomass, with an aeration unit that operates intermittently and adjustable, automatic evacuation of sludge;
- a disinfection unit using ultraviolet UV-C rays;
- a supply of treated water: a polyethylene tank of clarified water with a secondary supply of municipal water in compliance with standard DIN 1988 and a remote control boosting unit;
- automated control of the installation with a malfunctioning display, regulation of the parameters for the purification process, ...

The quality of the water treated corresponds to the hygiene/ microbiological requirements of the EEC directive on water for swimming of 8 December 1975.



↑ Illustration 387 : The difference between mechanical system and plants system (intensive or extensive system)

## E. REDUCE THE PRODUCTION OF WASTE



### E.1. REDUCE CONSTRUCTION AND DEMOLITION WASTE



### E.2. REDUCE DOMESTIC WASTE



## E.1. REDUCE CONSTRUCTION AND DEMOLITION WASTE

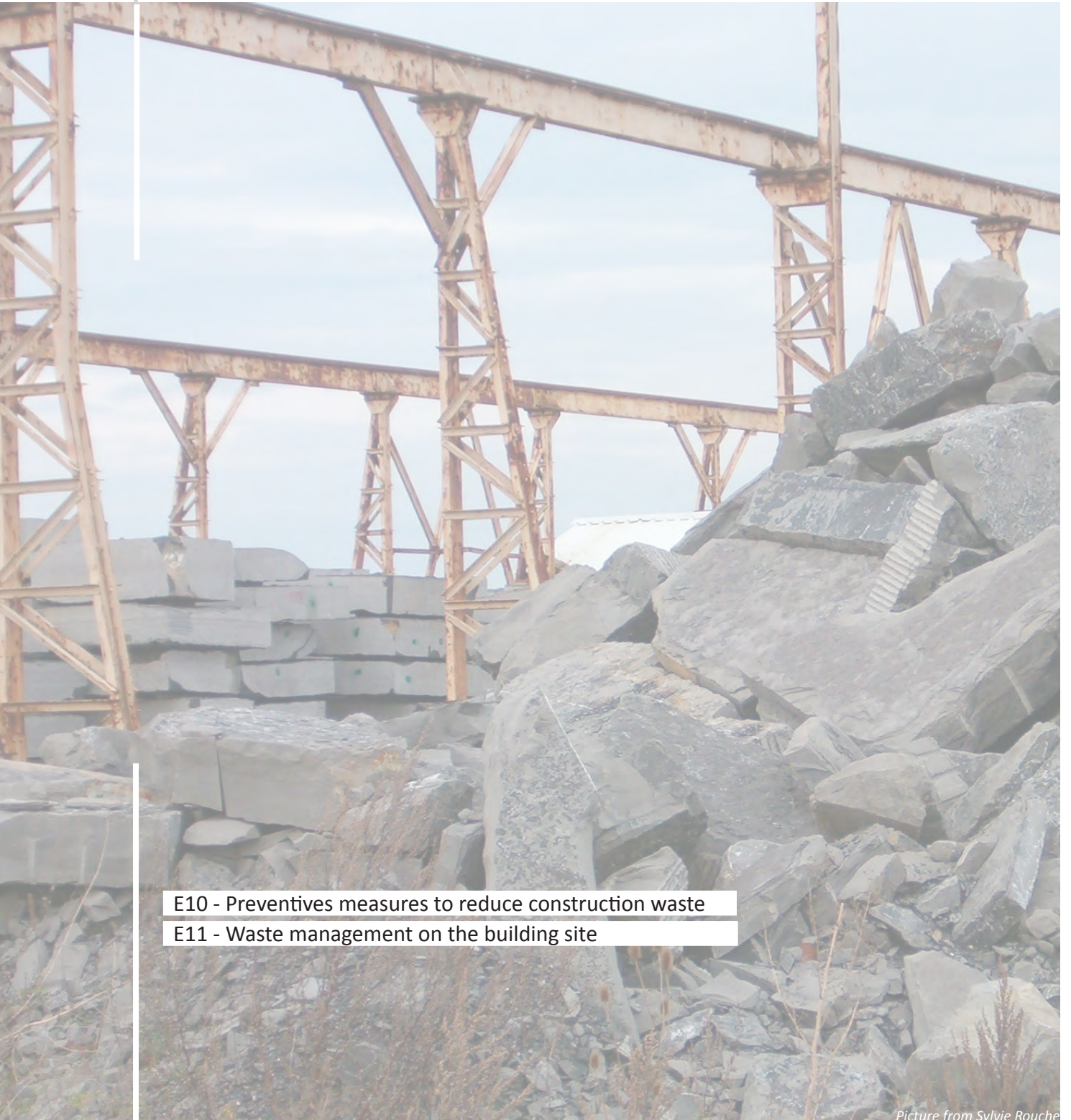

E10 - Preventives measures to reduce construction waste

E11 - Waste management on the building site

*Picture from Sylvie Rouche*





## E.1. REDUCE CONSTRUCTION AND DEMOLITION WASTE

### Preventive measures

N° of Sheet:  
**E10**  
 Cross-references:  
**E11, B20**  
 Appendix:  
 /

Work to renovate housing will inevitably entail a volume of waste both for the demolition work and for the actual renovation.

In terms of sustainable renovation of housing, three major guidelines should consequently be used to limit the quantity of waste taken to the dump or incinerated:

- Prevention – meaning limiting construction waste insofar as possible during the renovation and with regard to the future transformation or demolition of the building by certain preventive measures, such as the choice of the construction process and the choice of the building materials;
- Promoting recycling and reuse of demolition waste by sorting the waste on the construction site;
- When recycling is not possible, eliminating by two means: incineration with recovery of energy and taking waste to the dump.

#### 1. PREVENTIVE MEASURES IN THE DESIGN PHASE

First of all, it should be verified whether the existing building is suitable for the programme and the functions desired in view of its specific characteristics: area, ceiling height, lay-out of space, lay-out of openings etc.

Then, on creating the design, the designer will take care to:

- imagine renovation of housing units that will rationalize the use of materials
- imagine housing that can be broken down into modules over time, so that new functions can be installed, the interior can be restructured and/or extended without entailing a large volume of waste

Field	Environment	Society and economy
Rubbish dump	Emissions of pollutants due to the transport of waste Pollution of air and soil Impact on the landscape	High management cost Nuisances for the vicinity Health risk by polluting air and soil
Incineration	Emissions of pollutants due to the transport of waste Pollutants emission : CO <sub>2</sub> , SO <sub>2</sub> ,... Impact on the landscape	High management cost Nuisances for the vicinity Health risk by polluting air and soil

#### Building capacity to be adapted

*The capacity of a building to adapt to changing ways of life allows transformation to take place whilst containing nuisances from the construction process, production of waste and energy required for the transformation.*

Flexibility	allows for easy indoor restructuring This requires a flexible floor plan, fittings and equipment that can be dismantled and easily accessible ducting
Elasticity	allows for future extension (on the site, horizontally, vertically) This requires some specific thinking on the mass plan, volumetry and interior layout but also on the construction system and the façades
Evolvability	ability to keep up with technical or way of living evolutions
Neutrality	ability to absorb major changes in use This requires specific work on volumetry, structure and mechanical spaces

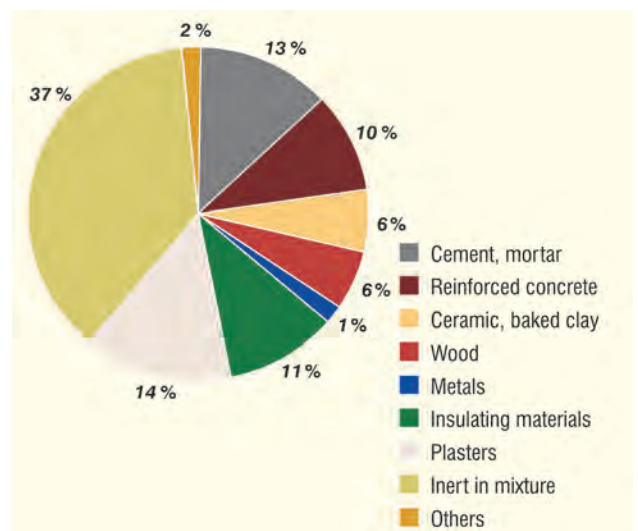

Preventive measures

N° of Sheet:  
**E10**  
 Cross-references:  
**E11, B20**  
 Appendix:  
 /

**2. PREVENTIVE MEASURES IN BUILDING SYSTEMS**

Construction processes and choices in construction should limit construction waste produced by the renovation sites insofar as possible.

To achieve this, the designer should take care to:

**- Work with standard dimensions and prefabricated structural components**

Using standard dimensions and prefabricated components in the construction process significantly reduces the production of waste on the construction site. The waste associated with the manufacture is sorted directly and more easily in the workshop. This solution also makes implementing easier (no need to take measures and cut to measure on the construction site) and significantly reduces the time needed for the works.

**- Using building techniques that will allow for easy disassembly in the future**

Mechanical assembling systems (nails, screw...), contrary to the assembling systems by joining (adhesive, cement, welding...) allow at the same time:

- an easy disassembling of various assembled materials
- a facility of sorting
- a higher rate of recycling



↑ Illustration 389 : Construction waste sorting on building site



↑ Illustrations 390 and 391 : Wood frame - easy to disassembling

**3. PREVENTIVE MEASURES ON SELECTING CONSTRUCTION MATERIALS**

The choice of building materials realized to the first steps of the life of a building will have more or less important consequences, at the end of the lifetime of this one, on the quantity of waste and management necessary to elimination and the valorization of this waste.

In a general way:

- we will exclude materials or products from construction generating of dangerous waste;
- we will consider the re-use of certain in situ materials, without preliminary treatment.

In term of sustainable renovation, it is advisable to carry out a choice of building materials by taking account of:

- *content of recycled matter*
- *capacity of building material to being recycled*
- *the deconstruction capacity of the material (attachment unit, possibility of being separated from other related materials)*

Note:

Although the industry of recycling is in full expansion, it appears also important to take account of the existing dies of recycling and their situation compared to the building site (die established in the area, the country or a country bordering).

↓ Illustrations 392 and 393 : Building materials with a high recycling potential

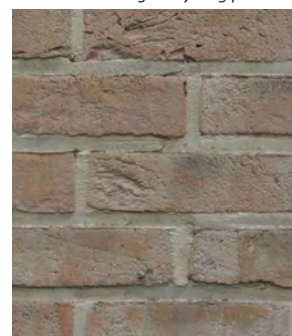

↓ Illustrations 394 and 395 : Building materials with a high recycling potential







## E.1. REDUCE CONSTRUCTION AND DEMOLITION WASTE

### Waste management on the building site

N° of Sheet:  
**E11**  
 Cross-references:  
**E10**  
 Appendix:  
 /



Picture : Arnaud Evrard

Effective waste management makes it possible to sort more waste at source, in order to make the most of it via recycling channels.

Effective management of demolition waste on the construction site means working in five phases:

- *Identifying the various materials integrated in the existing building that may become waste;*
- *Selectively disassembling (not demolishing) the various materials;*
- *Sorting waste in keeping with legal obligations for each country or region, as local conditions and the organization of the construction site will allow;*
- *Choosing the valorization process or if there is none, the elimination process;*
- *Identifying possible outlets.*

#### 1. PRE-STUDIES FOR WASTE MANAGEMENT

##### 1.1. Analysis of the site

The analysis of the site includes the following information:

Analysis of the building site	
Accessibility	Identification of constraints concerning evacuation of waste and procurement of materials.
Immediate environment	Identification of the neighbourhood and activities that could be integrated in the organization and management of the construction site.
Space organization	Identification of zones for storing waste.

##### 1.2. Inventory of the building and the components to be disassembled

Inventory of the existing building and its components that presents the following information in the form of an Excel spreadsheet:

Inventory of the building and its components		
type of materials	Measure unit	Waste quantity to remove
Identification of the various materials or components, giving information on the colour, material, dimension, trademark or model as well as the condition. In this way, the various fractions of waste can be determined (inert waste, metal, wood, ...).	Pce, mc, m <sup>2</sup> , m <sup>3</sup>	To be determined in kilograms or tonnes Consequently the costs of elimination or valorization as well as transport costs can be calculated.

This inventory should be accompanied with photographs to clearly identify the components that could be reused on the construction site or that could interest a potential buyer.

## E.1. REDUCE CONSTRUCTION AND DEMOLITION WASTE

### Waste management on the building site

N° of Sheet:  
**E11**  
 Cross-references:  
**E10**  
 Appendix:  
 /

#### 1.3. Evaluation of waste generated by the construction site

The building company should assess the quantity of waste produced on the construction site (disassembly and construction) per type of material used, and the quantity of waste produced for the duration of the construction site itself (offices, cafeteria, ...). These data can also be set out in a spreadsheet:

Evaluation of waste		
Type of waste	Unit	Quantity to remove
The various types of waste are as follows: - inert waste - wood waste - plastic waste - metals - domestic waste	pce, mc, m <sup>2</sup> , m <sup>3</sup>	To be determined in kilograms or tonnes An evaluation of the weight of waste is needed to quantify the number of containers.



↑ Illustration 396 : plaster waste

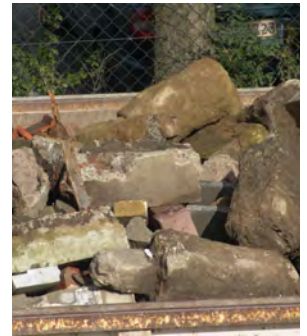

↑ Illustration 397 : Concrete waste

#### 1.4. Analysis of various possibilities for valorization

Analysis of the various channels for valorization and elimination will show:

##### - The location of the various channels

To limit the environmental and economic impact of transport insofar as possible, the channels closest to the construction site will be chosen.

##### - Quality required for material to be re-used

##### - Resale price (per m<sup>3</sup> or per tonne)

Today, certain channels for valorizing materials purchase construction waste. This is particularly the case for all the channels associated with metallurgy.

##### - What becomes of the waste in case it is resold

Traceability of waste can be established by thinking about the future of waste in the case of resale.

#### 1.5. Estimation of management costs

Along with the costs associated with the resale and transport of waste, the costs related to the management of the construction site itself should be estimated:

- Handling costs
- Labour costs
- Cost of renting pavement and length of street
- Cost of renting containers

#### 1.6. Waste management plan

Before the beginning of a construction site, the building / renovation company should establish a management plan based on prior studies and the chosen channels:

Waste management plan											
Fractions	Waste	Quantity	Weight (t)	Container (nbr)	Transport			Fields			Total
					Quantity (t)	Price/t	Total	Field	Price/t	total	
Waste category	Type of waste	M <sup>2</sup> ,mc, m <sup>3</sup> , pce		Type and necessary number							



↑ Illustration 398 : Wood waste sorting on building site

## 2. THE MANAGEMENT OF WASTE ON THE CONSTRUCTION SITE

### 2.1. Training on sorting on the construction site

Sorting on the construction site and selective demolition can only be done correctly if all persons working on the construction site are convinced that this is useful.

To achieve this:

**- The workers on the construction site should be trained, sensitized and involved**

The workers on the site should be trained in selective demolition and sorting. A rapid training course on the construction site is indispensable, including the following information:

- Types of fractions to be sorted and where the waste is to be stored;
- The operating method for selective demolition;
- The signs identifying containers;

Subcontractors should also be involved in waste management and be encouraged to sort.

**- Appointing a «waste manager» on the construction site**

Appointing a «waste manager» is indispensable to see that waste is sorted properly on the construction site. This person:

- verifies the quality of sorting;
- does continual awareness work with the workers and subcontractors;
- corrects any sorting errors;
- supervises the level to which containers are filled;
- sees to proper evacuation and the destination of the sorted waste

### 2.2. Putting containers in place

Management and correct location of containers on the construction site are an indispensable aspect of good waste management and sorting.

Preferably, there should be one container per type of waste.

**- Location of containers on the construction site**

An analysis of the construction site will show where space should be freed for the containers.

They should be set up in the same zone as follows:

- near a road to facilitate evacuation;
- immediately alongside the construction site to reduce the number of trips needed on the site;
- easily accessible for all workers.

If there is little room, there is a number of solutions:

- compartmenting containers
- temporary storage inside the building, near an exit, storage in big bags
- transfer of waste to a sorting centre

**- Packaging and signs on containers**

Packaging and signs on containers should facilitate sorting and the work of everyone on the construction site.

The size of the container should correspond to the waste to be stored in it:

- Light waste: large containers
- Heavy waste: big bags or small containers

↓ Illustration 399 : Container with concret waste



↓ Illustration 400 : Signposting of container



# Waste management on the building site

---

The containers should carry specific indications on what they can and cannot hold:

- Identification by informative signs
- Identification by notifying the elements accepted in the container

### **- Protection of the containers**

Containers should necessarily be protected against:

- unauthorized deposits of rubbish (from neighbours or other nearby construction sites)
- bad weather (wind, rain, ...)

Either tarpaulins or closed containers should be used.

### **2.3. Control and follow-up of the evacuation of waste**

Sorting the waste on the construction site is not enough, the waste must reach its destination and the channel for which it was sorted.

For this reason, the designer and the contracting authority should make sure that the documents and specific invoices for transport and processing of waste are followed up, controlled and kept by the contractor.

The contractor should keep the following information:

#### **- the order of transport:**

date, person responsible, shipping company, type of vehicle, waste, destination

#### **- transport:**

date of transport, shipping company, type of vehicle, waste, destination, value of the invoice

#### **- the treatment:**

date of reception, installation, waste, volume, type of treatment, value of the invoice

#### **- accounting:**

date, person responsible, date of order for payment.

The acceptance of the construction at the end of the works requires proof of controls and follow-up of the evacuation of waste. The contractor will give the contracting authority the specific documents and invoices for transport and processing of waste.

## E.2. REDUCE DOMESTIC WASTE



E20 - Preventive measures to reduce domestic waste

Picture from Sylvie Rouche





## E.2. REDUCE DOMESTIC WASTE

# Preventive measures to reduce domestic waste

N° of Sheet:  
**E20**  
 Cross-references:  
 /  
 Appendix:  
 /



Picture : S.Rouche

In Europe, on the average every person produces 430 kg waste per year, more than 1 kg per day.

Despite the organization of sorting of household waste, the quantity of waste produced is increasing with a growing percentage of packaging waste. Although designers cannot act directly on the occupants' behaviour, they can encourage selective sorting by a suitable interior design and layout.

### 1. PRINCIPLES FOR MANAGING DOMESTIC WASTE

To sort correctly, the occupants must:

#### - Clearly understand sorting instructions

Direct, explicit information should be preferred for this, which is not communicated exclusively by posters or signs:

- neighbourhood communication via a guardian, landlord or any other person close to the daily life of the occupants;
- signs on all equipment;
- a sorting guide distributed to families when they first move into the housing development.

#### - Have the means to encourage sorting of waste at their disposal

To correctly sort their waste, the occupants need to have the following at hand:

- a sorting area integrated in the kitchen
- a common storage area adapted to the needs of the community, well maintained and easy to access.

This is where the designer has an important role to play in the interior lay-out of the housing units and related premises.



↑ Illustration 402: Various types of dustbins and instructions

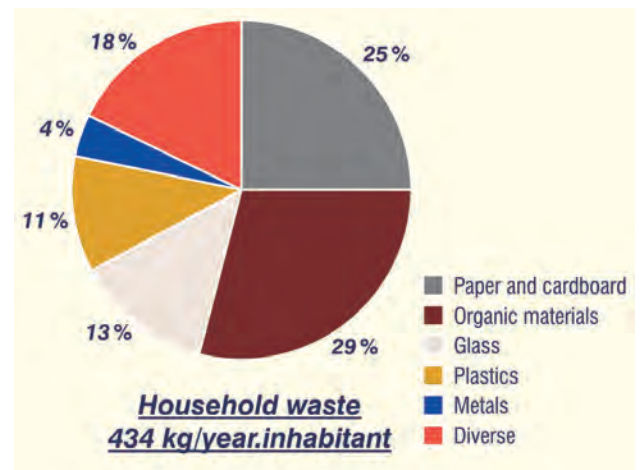

↑ Illustration 401: Quantity of domestic waste produced by year

### 2. SORTING AND STORAGE SPACE

All occupants, whether they live in an apartment or a house, should be able to sort their waste comfortably, in their living area, and store it in a space near the dwelling without creating nuisances for their life style.

To achieve this, an effort should be made pertaining to:

- the private sorting area
- the common storage area

#### 2.1. Private area used for sorting

In terms of sustainable renovation and particularly renovation of collective housing, when plans are being made for the interior lay-out of the apartments, designers should include an individual area to be used for sorting, preferably in the kitchen. The size of this area should be such that every occupant can store at least the number of rubbish bins required by the legislation and regulations in force.

This sorting area should be integrated attractively in the layout of the kitchen.

## Preventive measures to reduce domestic waste

### 2.2. Collective storage area

#### - Number and type of storage areas

A sufficient number of common storage areas should be set up in view of the needs of the building to be renovated.

Basic needs are defined by the intrinsic characteristics of the building to be renovated, those being:

- the number of dwellings
- the number of inhabitants
- the flow of waste and the frequency of waste collection

In addition, the designer should also provide a storage space for oversized waste, to avoid unauthorized dumping in collective storage premises or along public streets.

#### - Location of the storage areas

Locating storage areas in the apartment building is an important element of good household waste management. A storage space that is too far from the housing or along an unusual path will discourage sorting.

The common storage areas for waste should be located near the dwellings and along a usual path for the occupants, either inside the building, or immediately outside, near the public street.

The storage premises for oversized waste should be set up along the public street and be easily accessible by the waste collection company.

#### - Facilities in storage areas

To facilitate maintenance, each storage area should:

- be equipped with a water supply and a drain on the floor;
- preferably tiled.

Each common storage area should be correctly identified: posters in the lobby and common areas, signs with instructions for sorting, stickers on the containers or trapdoors for sacks, ...

### 3. CONTAINERS

Clearly identified, well suited material that facilitates the job of sorting and collection will encourage occupants to sort their waste.



↑ Illustration 403: Fitting of storage space



↑ Illustration 404: External storage space with various traps

Type of storage space	Dimensions	Surface au sol	Fitting
Outdoors	<p>The outdoor storage premises should be suitable for the volume and frequency of waste collection.</p> <p>They should be large enough to hold the containers required by the legislation and regulations in force.</p>	<p>Common storage premises should have a total floor area of :</p> <ul style="list-style-type: none"> <li>• <math>5.5 \text{ m}^2 + (0.14 \times \text{number of occupants})</math> if there are fewer than 50 occupants</li> <li>• <math>8 \text{ m}^2 + (0.09 \times \text{number of occupants})</math> if there are more than 50 occupants</li> </ul> <p><i>These formulae for sizes are given for waste collection twice a week. The areas of 5.5 and 8 m<sup>2</sup> correspond to the minimum needed for the circulation of the bins, opening the door, ...</i></p>	<p>The common outdoor storage area should be locked, both for the public and the occupants of the building.</p> <p>The storage premises should have at least five trapdoors:</p> <ul style="list-style-type: none"> <li>• 2 for household waste</li> <li>• 1 for paper and cardboard</li> <li>• 1 for plastic</li> <li>• 1 for glass</li> </ul> <p>The premises should be equipped with a door that can be locked; access should be limited.</p>
Indoors	<p>The indoor storage premises should be large enough for:</p> <ul style="list-style-type: none"> <li>• setting up and moving the containers required by the legislation or regulations in force</li> <li>• moving and handling sacks by persons doing the sorting</li> </ul>	<p>Common storage premises should have a total floor area of :</p> <ul style="list-style-type: none"> <li>• <math>5.5 \text{ m}^2 + (0.14 \times \text{number of occupants})</math> if there are fewer than 50 occupants</li> <li>• <math>8 \text{ m}^2 + (0.09 \times \text{number of occupants})</math> if there are more than 50 occupants</li> </ul>	<p>The common indoor storage areas should be:</p> <ul style="list-style-type: none"> <li>• well lit (minimum 300 LUX)</li> <li>• clean</li> <li>• well aired</li> <li>• easily accessible</li> </ul>





↑ Illustration 405: External storage space



↑ Illustration 406: Various types of containers

### 3.1. Type of container

The choice of containers should be made in view of the following aspects:

- suitable for the volumes of waste and frequency of waste collection
- suitable for the size of the storage premises
- limiting sorting errors
- convenient to use for occupants (easy to handle, convenient opening, ...)
- easy to maintain

It should be noted that small containers are easier to handle and to move than large ones.

### 3.2. Signs

Each container should be clearly identified by the type of waste collected:

- the cover should be the same colour as the corresponding sacks
- a poster should be displayed on the container with instructions for sorting

## 4. AWARENESS OF OCCUPANTS

### 4.1. Developing communication locally

The contracting authority should use local communication to improve awareness and inform occupants of the building about sorting their waste. If there is a housekeeper or manager for the building, that person should be trained in sorting waste and have a sufficient stock of information sheets to be distributed as the need may arise, and particularly when new occupants arrive.

### 4.2. Clearly communicating instructions for sorting

The contracting authority, with the help of the designer, should clearly and meaningfully communicate instructions for sorting. This communication should be done by means of:

- permanent signs on all equipment used for selective waste collection (storage premises, containers, ...)
- a sorting guide distributed to all new tenants when they arrive
- a reminder of the sorting instructions to be posted in each kitchen

## 5. OUTDOOR AREAS

Household waste management should also be integrated in the green areas or landscaping around the apartment buildings.

To do this, the design should take care to:

- place a sufficient number of rubbish bins around leisure areas, playgrounds and footpaths
- place rubbish bins near the entrance or entrances to the building
- use sufficiently sturdy, resistant rubbish bins, that close fairly well (to keep animals out)
- use rubbish bins that are easy to maintain and to empty for waste collection.



## F. REDUCE CONSUMPTION OF TERRITORY AND RESOURCES

F01 - Embodied energy

F02 - Construction materials

*Picture from Architecture et Climat*





F. REDUCE CONSUMPTION OF TERRITORY AND RESOURCES

Reducing embodied energy consumption

N° of Sheet:  
**F01**  
 Cross-references:  
 /  
 Appendix:  
 /

«It is currently considered in France, that the energy included in the components of a building corresponds to the equivalent of about 20 years of its consumption of heat (based on a standard housing unit that complies with thermal regulations) but not more. This value increases considerably with more energy effective buildings: for a low energy house, it rises to nearly 60 years and for a very low energy house, it is more than a century.

Consequently, it is easy to see that, alongside the current priority (constructing housing that is easy to heat and does not need air conditioning), the global energy cost of materials and buildings must be taken into account right away.»

Source: La conception Bioclimatique, Jean-Pierre Oliva

This affirmation is also confirmed in Switzerland, where the energy required to manufacture all the materials used to construct a building corresponds to about what it takes to heat a well insulated building for 30 or 40 years.

1. DEFINITION

Embodied energy is all energy used for the construction or renovation of the dwelling.

Embodied energy is the total energy expended at the time of the design of a product for the material, extraction and transport of raw materials, processing of raw materials, manufacture and marketing of the product, the implementation of the product and treatment at the end of its service life.

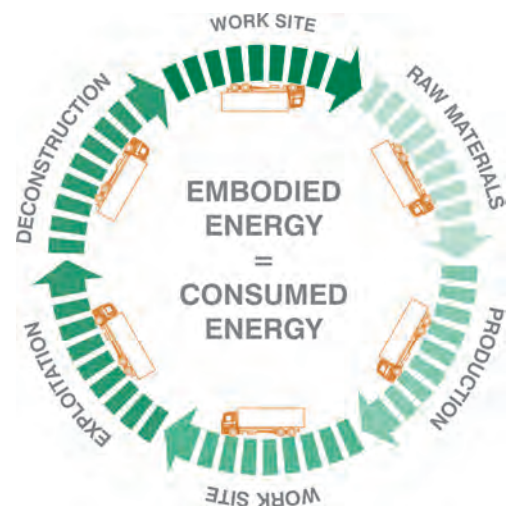

↑ Illustration 407: Definition of embodied energy

2. PRINCIPLE OF REDUCING EMBODIED ENERGY

Renovation of existing housing in itself represents considerable saving of embodied energy as compared to the construction of new housing, since:

- it maintains at least the structure of the building, representing savings of about 626 kWh per m<sup>3</sup> of reinforced concrete preserved;
- it takes advantage of existing networks (electricity, gas, transport, ...);
- it limits the quantity of waste (as compared to complete demolition and reconstruction).

↓ Illustration 408 : Impact of construction materials on embodied energy consumption (NRE - MJ-eq)

However, embodied energy can be further reduced on renovation in the following way:

- by the choice of building materials and products;
- by the layout and fittings in the dwelling, so it can easily adapt to future occupancy needs and transformations.

3. CHOICE OF BUILDING MATERIALS

For an equivalent technical performance, it is crucial to choose a building product or material that uses little gray energy.

To do so, the designer should use a life cycle assessment (LCA) that shows the potential environmental impact throughout the life cycle of a product, from mining of raw materials to production, use, and treatment at the end of its service life, recycling and discarding.

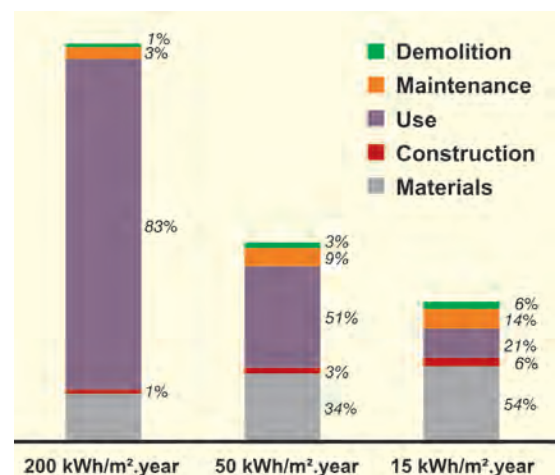

## F. REDUCE CONSUMPTION OF TERRITORY AND RESOURCES

### Reducing embodied energy consumption

N° of Sheet:  
**FO1**  
 Cross-references:  
 /  
 Appendix:  
 /

Embodied energy should always be compared on the basis of the density of the building material and the quantity of the material needed for quality implementation.

Certain tools can help a designer in this approach. They include:

- KBOB eco-reports – [www.bbl.admin.ch/kbob](http://www.bbl.admin.ch/kbob)
- The LCA ECOINVENT database – [www.ecoinvent.ch](http://www.ecoinvent.ch)
- LCA software such as ECOSOFT, ECOBAT,...

Material per kg of material	Embodied energy production process MJ-Eq/kg	Embodied energy elimination process MJ-Eq/kg
Block of concrete (2400kg/m <sup>3</sup> )	0.616	0.201
Brick of terra cotta (1000kg/m <sup>3</sup> )	2.84	0.188
Plaster (1800kg/m <sup>3</sup> )	1.43	0.301
Sheet of steel (37% recycling)	29.8	0
MDF panels (780kg/m <sup>3</sup> )	39.2	0.164
Mineral wool (100kg/m <sup>3</sup> )	21.9	0.262
Foam of PUR (30kg/m <sup>3</sup> )	103	1.38

Embodied energy needed for material production and elimination  
 Source: Ecobilans KBOB 2009/1 - [www.ecobau.ch](http://www.ecobau.ch)

Example :

#### Comparison between 4 different modes of walls construction (embodied energy consumption/1m<sup>2</sup> of wall)

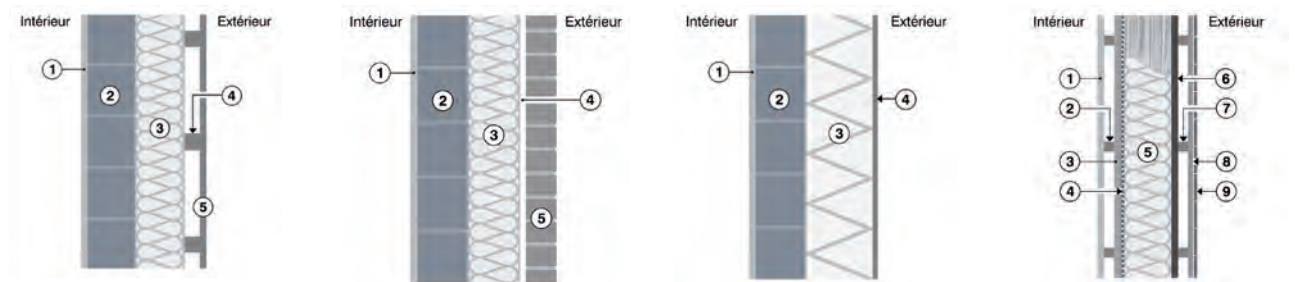

##### Composition

1. Lime plaster
2. Concrete block with cement mortar
3. Insulation: wood wool panel
4. Lathing in resinous wood
5. Cladding in resinous wood

##### Composition

1. Lime plaster
2. Concrete block with cement mortar
3. Insulation: EPS panel
4. Air vacuum
5. Brick with cement mortar

##### Composition

1. Lime plaster
2. Concrete block with cement mortar
3. Insulation: wood wool panel
4. Mineral coating (cement and lime)

##### Composition

1. Wood panel (resinous)
2. Lathing in resinous wood
3. OSB panel
4. Vapour barrier
5. Insulation : cellulose in bulk between wood frame
6. Wood panel
- 7/8. Lathing in resinous wood
9. Cladding in resinous wood

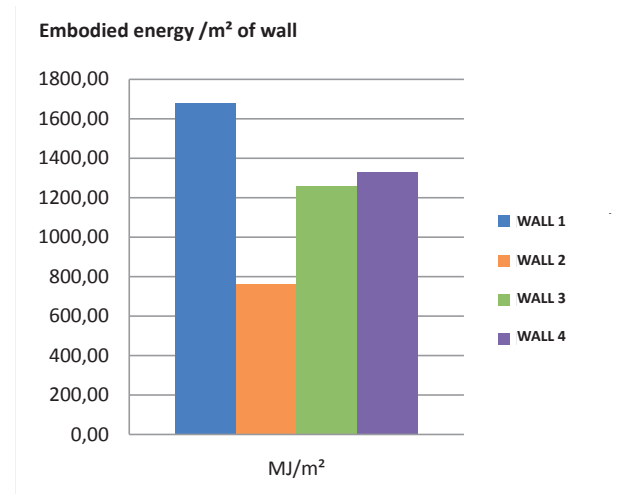
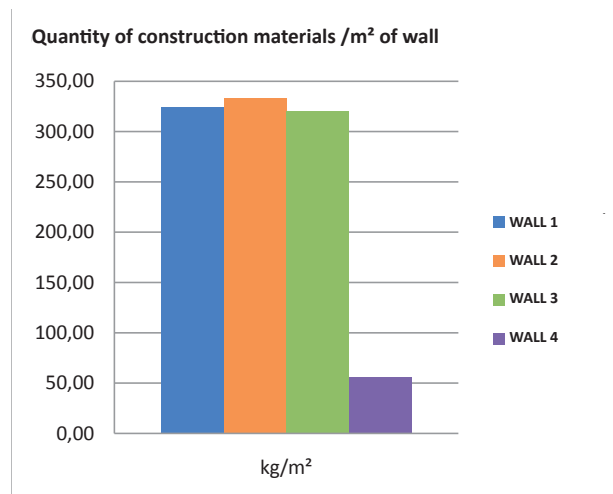

Source : Results coming from construction materials research - Architecture et Climat(Louvain la Neuve - Belgium)

#### 4. FITTING OUT THE INTERIOR OF THE DWELLING

##### 4.1. General

*The following text has been translated word for word from the book «Qualité environnementale des bâtiments» (Environmental quality of buildings) published by ADEME.*

Any building constructed or renovated today is going to go through evolution, or even radical changes, in its use. Life styles, living and working habits change, as much as techniques.

The adaptability of a building refers to its capacity to adapt to these changes without altering its usage or the services it provides – this corresponds to a sustainable approach at the lowest possible environmental cost (waste, raw materials, energy).

##### **- Flexibility**

The flexibility of a building is measured by the facility of reorganization of its interior areas. This supposes that there is a modular plan, with interior fittings that can be disassembled and possibly reused, as well as easily accessible networks.

In addition, it should be possible to carry out these operations on the site itself, with a minimum of nuisances and waste production.

##### **- Elasticity**

Elasticity is the capacity for extension (or compression by division) of a building. The simplest and most common response consists of putting an extension on the part of the grounds that has been kept for that purpose. There can also be extensions of buildings:

- horizontally: development of levels beyond the façades initially constructed
- vertically: elevation, occupancy of basements or extension of the groundwork

Elasticity entails giving special thought to the block plan, volumetry and fitting out of the interior, as well as the system of construction and the façades.

##### **- Capacity to evolve**

A building's capacity to evolve refers to its ability to integrate evolution or innovation both in the field of technical performance (heating, ventilation, lighting) and in life styles (housing units) and in the conception of working areas (offices and services).

This entails a certain neutrality of the building (structure, envelope, interior fittings) with regard to the technical equipment.

##### **- Neutrality**

Neutrality is the capacity of the building to accept a major change in usage. This requires special work on volumes, and the technical and structural cores of the building.

***Means to be used to maintain the adaptability of the housing to be renovated***

*The means to be used are as follows:*

- *give priority to dry techniques or techniques that can be disassembled*
- *give priority to a pattern or a modular approach (large housing complexes)*
- *give priority to mechanical fastenings to facilitate disassembly*
- *give priority to visible techniques*
- *overestimate the size of some equipment*







F. REDUCE CONSUMPTION OF TERRITORY AND RESOURCES

Construction materials

N° of Sheet:  
**F02**  
 Cross-references:  
 /  
 Appendix:  
 /



Picture: A.Branders

The choice of a building technique, component or construction material is generally based on criteria such as functionality, technical performance, architectural esthetics, economic cost, durability and maintenance. Nevertheless, this choice is never neutral from the standpoint of the consumption of energy and non-energy resources, the environment and health.

In fact, any building material or product, at the time of the extraction of the raw materials, manufacture, implementation and demolition, consumes resources and energy and creates nuisances (toxic emissions, waste, ...) both for the environment in general, and for the health of living beings.

1. ENVIRONMENTAL AND HEALTH IMPACTS OF CONSTRUCTION MATERIALS

1.1. Consumption of energy resources

- Consumption of fossil energies

Based on our current consumption, it is estimated that known reserves of fossil fuels will be exhausted in less than a century. The various phases of the life of building materials, particularly the manufacturing process and the treatment at the end of their service life, consumes more or less energy depending on the type of material. Today, this energy is essentially produced from fossil fuels since the share of renewable energies in the manufacturing process is about 5 to 15% in the best of cases.

When we speak about consumption of energy and construction materials, it is important to integrate the consumption of fossil energies related to the various types of transport used to carry the raw materials and finished products, as well as the technical means used on a construction site (construction machines, cranes etc.).

- Embodied energy

Contracting authorities and designers are increasingly concerned with creating high-performance buildings in terms of energy in order to reduce their consumption sharply. This objective is crucial, but it is also important to consider the problem of «energy» on the whole. By taking account of both the energy for use (that the building consumes when it is occupied), and gray energy or embodied energy needed to manufacture, implement and process the components and systems at the end of their lives. In fact, the better the building's performance in terms of energy consumption in use, the greater the share of gray energy in overall consumption.

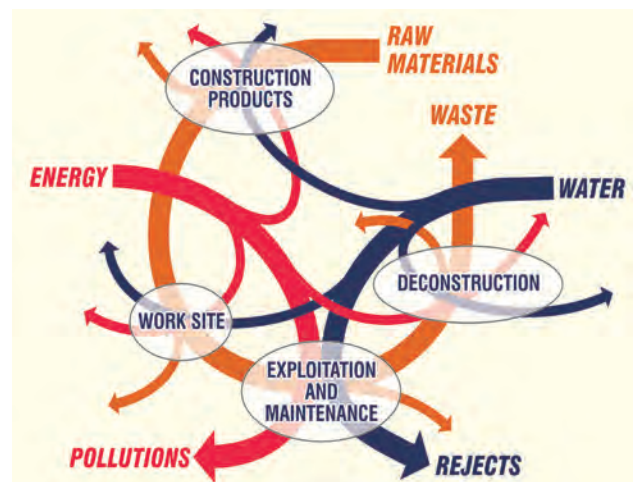

↑ Illustration 409: Building life cycle by E. Dufresnes

## Construction materials

### 1.2. Consumption of non-energy resources

#### - Consumption of raw materials and water

Building materials consume more or less water and raw materials depending on the type of materials and the manufacturing process.

*Example:*

- 1 m<sup>3</sup> (about 2400 kg) of normally heavy reinforced concrete poured on site in Belgium requires approximately 350 kg of cement, 1800 kg of aggregates (sand and other), 100 kg of reinforcing bars and 200 litres of water.

- 1 tonne of clinker (1 m<sup>3</sup> of cement) requires 1.7 tons of raw materials.

The raw materials used for the most part are renewable substances (mainly natural plant substances that are renewed more or less rapidly) and non-renewable substances (aggregates, stones, petrochemical substances and so on that have taken tens of millions of years to be formed in our subsoil).

Consequently, our non-renewable resources should be saved, and we should give priority to using renewable resources with a high renewal rate.

Building methods used on the construction site will also have an influence on the quantity of matter and the volume of water to be used.

*Example:*

A wooden frame construction as compared to a traditional construction with concrete slabs and masonry blocks.

Consequently, priority should be given to methods of construction that use relatively little raw materials and water, particularly by favouring dry manufacture and construction methods.

#### - Potential of raw materials made from recycled products

The manufacture of raw materials, their implementation on the construction site, and their disassembly cause waste.

This waste can either be treated in a traditional way (high cost, major impact on the environment) or be valorized as a «secondary» raw material.

The recycling or resale should of course be given priority because they limit the use of our «material» resources and save energy and financial resources.

*Example:*

*Inert materials (concrete, bricks):*

- average price of recycling: € 8.5/tonne (source: MEDECO)

- average price of dump: € 10/tonne (source: MEDECO)

*Manufacture of aluminium from mined raw materials:*

- 116.1 MJ/kg (source: ECOSOFT)

*Manufacture of aluminium from recycled aluminium waste:*

- 19.5 MJ/kg (source: ECOSOFT)

However, recycling construction waste for use as a secondary raw material means that it must be sorted. While sorting manufacturing waste (rejects, offcuts, ...) is easy, it is less so for waste produced during implementation and demolition.



↑ Illustration 410: Stones extraction in Belgium



↑ Illustrations 411 and 412: Natural resources : stone and wood



Illustrations 413, 414 and 415: Materials with a high recycling potential : concrete and metals



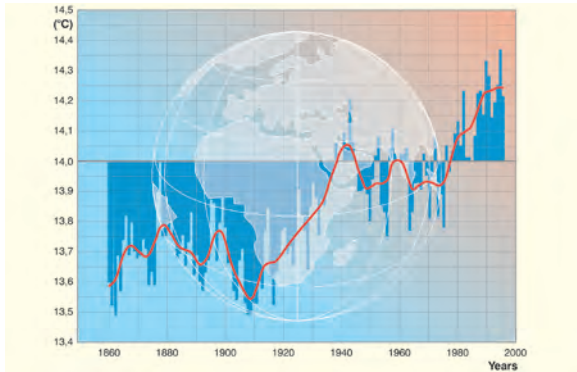

↑ Illustration 416 : Global Warming since 1860



↑ Illustration 417: Production of waste on building site



↑ Illustration 418: Production of waste on building site

### 1.3. Impact on the environment

The impacts of materials on the environment can be of many kinds and should be considered over the entire service life of the material.

#### - Air pollution

The extraction of raw materials, manufacturing processes, implementation on the construction site, treatment at the end of the service life and the various transport phases – essentially using fossil fuels – are processes that emit atmospheric pollutants, the most important of which are carbon dioxide (CO<sub>2</sub>), sulfur dioxide (SO<sub>2</sub>), nitrogen oxides (NO), volatile organic compounds (VOC), and fine to very fine particles.

These various pollutants cause major damage to the environment such as global warming, acidification of the air, water and soil, reduction of the ozone layer and the formation of tropospheric ozone.

#### - Impact on the landscape and biodiversity

The use of certain raw materials or certain manufactured materials can have damaging consequences on the landscape, biodiversity and existing ecosystems. This is particularly the case for deforestation of forests in Canada and Siberia, certain gravel and stone quarries, mining of minerals or metals, ...

#### - Production of waste

Manufacture, implementation and demolition inevitably produce waste. Most construction waste today has an intrinsic recycling value, but, for lack of technical means or disassembly and sorting, it is often handled through traditional waste removal channels, in other words, it is incinerated or is sent to the dump. These traditional channels for treating waste have a significant impact on the environment (air pollution and risk of soil pollution or water pollution), they are often expensive, and their exploitation will be limited in future years (under European standards).

### 1.4. Impact on health

The impact of materials on human health is a relatively new field and one that is just getting started. There are still many unknown factors, particularly concerning «harmful» raw materials introduced in manufacturing processes or implemented on a construction site, and the way they react with a given building material, the way they react to damp, in what quantity the substances become truly harmful for health, and so on.

Reliable information does exist already, however, on certain substances or pollutants, and we have established criteria for choosing them on this basis.

#### - Use and emission of harmful substances (manufacture and implementation)

Primary emissions from materials are caused by the components of those materials. These emissions are high immediately after manufacture, they drop by 60 to 70% in the first six months and by and large disappear entirely one year after they have been incorporated or used. Many toxic substances such as heavy metals (lead, cadmium, mercury, zinc and arsenic), biocides, fungicides, certain solvents (toluene, benzene, xylene), volatile organic compounds (formaldehyde) and certain additives (fire retardants and others) are still commonly used as a raw material in manufacturing construction materials.

## Construction materials

These substances have significant effects on the health of living beings and the environment:

- heavy metals
- hydrocarbon solvents (toluene, benzene, ...)
- volatile organic compounds
- brominated fire retardants

The people who are most exposed to substances and emissions of these substances are the workers involved in the manufacturing process and those using these materials on construction sites.

### - Air pollution

The extraction of all materials, manufacturing processes, implementation on the construction site, treatment at the end of their lives and the various transport phases – essentially using fossil fuels – are processes that emit atmospheric pollutants the most important of which are carbon dioxide (CO<sub>2</sub>), sulfur dioxide (SO<sub>2</sub>), nitrogen oxides (NO), volatile organic compounds (VOC), and fine to very fine particles.

These air pollutants not only have major impacts on the environment but also have significant consequences on our health.

Many international studies have shown that air pollution can be seriously harmful to our health, even if the consequences are not always easy to quantify.

Several recent epidemiological studies have shown:

- that there is a relation between the combination of various air pollutants such as dust and ozone, and the number of hospitalizations due to heart disease.
- that long-term exposure to fine particles (PM<sub>10</sub>) and very fine particles (PM<sub>2,5</sub>) represents the main health risk of air pollution. It is estimated that this exposure results in early deterioration of the quality of life of 1 to 18 months.
- Pollution affects everyone differently depending on the degree of exposure to pollutants, sensitivity, the general state of health etc. The people who are affected fastest are mostly children and the elderly.

The respiratory system is the first target of air pollutants that penetrate by means of the air we breathe. The effects can go from temporary disorders to permanent respiratory malfunctioning or chronic diseases.

### - Quality of indoor air

Depending on our activities, we spend 80 to 90% of our time in an indoor environment (housing and work).

The quality of the indoor environment of a building depends on many factors related to the building and its usage on one hand, and to the quality of the exterior environment on the other.

Nevertheless, the majority of the pollutants present indoors come essentially from inside sources – often making the quality of indoor air less good than the quality of outdoor air.

Among these we can identify:

- the construction materials and essentially the finishing materials in direct contact with the interior atmosphere and the occupants
- technical installations, particularly installations for producing heat and hot water
- furniture and decorative accessories (e.g. rugs and curtains)
- human presence and human activities
- the presence of pets

As housing is increasingly insulated, pollutants as well as damp can accumulate. This concentration can result both in the deterioration of the building and have a significant effect on our



↑ Illustration 419 : New pictograms showing the impacts on health



↑ Illustration 420 : Various stages in the material life - for life cycle analysis

health (discomfort, fatigue, headaches, allergies, intoxication, increase in asthma in children, ...).

## 2. OBJECTIVES

In terms of «sustainable» construction, choosing a construction material or product responsibly from the standpoint of citizenship means taking account, for the entire duration of the service life of the components, of:

- technical and/or physical performances
- incidence on the environment
- an energy audit
- a health audit (workers and occupants)
- the economic budget

Calculating these five aspects is not easy to do, particularly for lack of objective, quantifiable data as concerns the incidence on the environment and on health.

For this reason, the objective of this information sheet is to determine actions and guidelines that can help limit impacts of building materials and construction techniques on the environment and on health.

### 2.1. Guidelines

The main guidelines that can help the designer or the contracting authority in choosing building materials are as follows:

#### 1. Rationalize the use of materials

Then, for an equivalent technical performance:

2. Choose building materials with a limited impact on the environment
3. Choose building techniques with a limited impact on the environment
4. Choose building materials with a limited impact on health (of workers and occupants)

### 2.2. Rationalize the use of building materials

Rationaliser l'usage des matériaux de construction signifie à la fois limiter l'usage de ceux-ci (n'utiliser les matériaux que lorsque c'est réellement nécessaire) et utiliser des matériaux ayant une durée de vie importante et demandant peu ou pas d'entretien.

#### - Rationalize the use of construction materials

The material that has the least impact on health and the environment is a material that isn't used.

The designer should therefore take care:

- to minimize the quantities of materials used, particularly by carefully sizing the structural elements;
- to prefer materials with little processing;
- when possible, to prefer «rough» surfaces (i.e. with no finishings), such as visible bricks or concrete.

#### - Life cycle and maintenance of materials

Each material, once it has been incorporated, has an average service life expectancy that varies with the intrinsic quality of the material, the way it was implemented and its maintenance (if it needs maintenance).

The designer should prefer materials:

- that are as durable as possible:
  - > 15 years for finishing materials;

### Construction materials

---

> 40 years for materials in the building shell

- need little or no maintenance;
- can be implemented in a fixed, lasting way

#### 2.3. Choice of materials with a limited impact on the environment

##### - *Type of raw materials*

The questions to be asked are as follows:

- *Are the raw materials natural or have they been processed (byproducts of the petrochemical industry, the chlorine industry, or another)?*
- *Are the raw materials renewable, and to what extent?*
- *Are the raw materials rare, available in limited, sufficient or unlimited quantity?*
- *Does extraction of the raw materials cause nuisances for the environment?*

The designer should give priority to:

- Natural materials
- Renewable materials with a sufficiently high rate of renewal (renewal < 15 years)
- Raw materials present in sufficient and/or unlimited quantity
- Raw materials whose extraction or exploitation causes little or no nuisances for the environment.

##### - *Origin of raw materials*

The questions to be asked are as follows:

- *What is the geographic origin of the raw materials or the building material role – regional, national, European, world-wide?*
- *What means of transport is used to carry the raw materials: cargo ship, train, lorry, ...?*

Local materials and/or materials coming from neighbouring countries, should be given priority for the following reasons:

- these materials are often better suited to the local climate and have an optimal service life in bad weather;
- these materials can significantly reduce the environmental impact of transport.

##### - *Consumption of energy resources*

The questions to be asked are as follows:

- *Does the manufacturing process of the material require a lot of energy?*
- *Does the manufacturing process of the material chosen use fossil energies or renewable energies?*

For an equivalent technical performance, the designer should choose:

- the material whose manufacturing process uses the least gray energy
- the material whose elimination process uses the least gray energy

These choices can only be made in full knowledge of the question. The designer should therefore use certain tools such as the KBOB eco-reports, NIBE standards or specific software like ECOBAT or ECOSOFT.

N° of Sheet:	F02
Cross-references:	/
Appendix:	/

**Note:**

*It is also useful to:*

- prefer manufacturing processes that use renewable energies;
- consider gray energy over the entire life of the material

terra-cotta brick facing (density 1550 kg/m <sup>3</sup> ):	Mineral coating material (density 1500 kg/m <sup>3</sup> ):
service life > 100 years	service life : 20 years
gray energy (manufacture): 2.84 MJ/kg or 396 MJ/m <sup>2</sup> (for a thickness of 9 cm)	gray energy (manufacture): 1.72 MJ/kg or 52 MJ/m <sup>2</sup> (for a thickness of 2 cm)
ratio: 0.0284 MJ/kg or 3.96 MJ/m <sup>2</sup>	ratio: 0.0573 MJ/kg or 2.6 MJ/m <sup>2</sup>

**- Emission of air pollutants (during manufacture)**

The questions to be asked are as follows:

- What type of fossil or renewable energy is used in the manufacturing process (diesel fuel, gas, electricity, biomass, ...)?
- Does the manufacturing process for the material chosen emit air pollutants such as CO<sub>2</sub>, SO<sub>2</sub>, NO, NO<sub>x</sub>, VOC, fine to very fine particles?

For an equivalent technical performance, the designer should choose:

- the material whose manufacturing process emits the least pollutants;
- the material whose elimination process emits the least pollutants.

These choices can only be made in full knowledge of the question. The designer should therefore use certain tools such as the KBOB eco-reports, NIBE standards or specific software like ECOBAT or ECOSOFT.

Like gray energy, emissions of air pollutants should be considered for the entire life of the material.

**- Recycling potential and the recycled substances introduced in the manufacturing process**

All materials produce waste at the time of their manufacture, implementation and elimination.

Today, more and more manufacturers are reusing manufacturing waste in the production cycle in order to optimize the use of resources and raw materials. As concerns waste produced at the time of the implementation of the material, and depending on its nature and the way it is assembled on the construction site, this waste can be reused or recycled.

To encourage recycling channels for construction waste, the designer should take care to:

- use building materials whose production process incorporates a high percentage of recycled substances
- use building materials with a high potential for recycling

**2.4. Choose a building technique with a limited impact on the environment**

By his choice of implementation of the building procedure, the designer can limit the use of resources (materials and water), reduce the production of waste, reduce consumption of energy, limit production of pollutants and above all, allow disassembly and sorting, and consequently promote recycling.

**- Building techniques**

The questions to be asked are the following:

- Does the building method use little matter, water and energy?
- Does the building method favour prefabrication?
- Does the building method reduce the duration of the construction site?
- Does the building method favour standard dimensions?
- Does the implementation method use mechanical assemblies?

Building methods favouring prefabrication should be given priority for the following reasons:

- Rationalization of resources (raw materials and water) and transport
- The construction site is often «dry»
- Ease of implementation
- Better waste management on the construction site (no off-cuts, no joining, ...)
- Shorter duration of the construction site and of its disadvantages

The designer should therefore take care to:

- Prefer prefabrication;
- Use materials or products in standard dimensions; this means doing more drawings beforehand, but it can significantly reduce waste produced on the construction site.

**- Fastening and assembly systems**

Fastening and assembly systems can have an impact on the environment and on health, and in priority they will affect the capacity of materials to be «disassembled» and recycled or resold:

- fastening systems using glue or tar products mean that the building materials (finishings or shell work) are not easy to disassemble;
- mechanical fastening systems (using screws and nails) facilitate separation of materials or components.

In addition, it has been clearly shown that fastenings using glue have a greater impact on health (emission of solvents, VOC, formaldehyde, ...).

In addition, whether the structure is massive (concrete and masonry blocks) or made from wood, the fastening systems (mortar, adhesive mortar, glue, metal parts) will have a more or less significant part in the environmental balance.

*Example:*

*For 1 m<sup>2</sup> of bearing masonry, the share of «mortar» is about 10 to 15% of the area (depending on the type of blocks of bricks) with about five units of anchoring metal hardware on the average.*

*The choice of the type of mortar and metal used (stainless steel or galvanized steel) will influence the environmental balance.*



↑ Illustration 421 : Masonry work

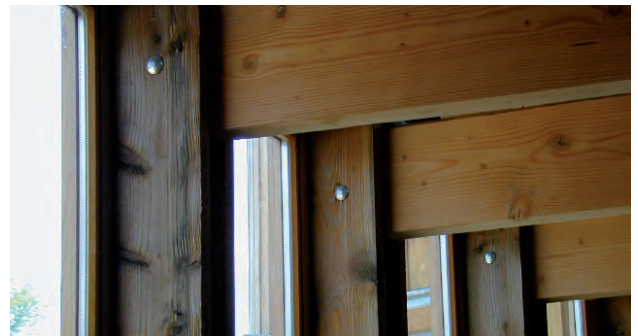

↑ Illustration 422 : Wood frame work

↓ Illustrations 423, 424, 425 and 426 : Various systems for materials assembling





Consequently, the designer should take care to:

- Prefer fastening systems that allow for the separation of the materials and reversibility of the techniques so that the materials can be resold or reused;
- Limit the use of compound, non-dissociable materials (consisting of several layers of materials, glued together).

**- Quality of implementation**

The quality of implementation will have a direct impact both on the service life of the materials and on the quality of the air (finishing materials) and the health of the occupants.

Consequently, it is crucial to collect information on standards in application plus recommendations from professionals to avoid having to demolish what has been constructed because of inappropriate implementation.

**2.5. Choose a building material with a limited impact on health**

**- Utilization and emission of harmful substances (during manufacture and implementation)**

Manufacture and implementation of certain materials requires the use of substances that are harmful to health. This is particularly the case for volatile organic compounds including formaldehyde and hydrocarbon solvents, heavy metals (lead, zinc, cadmium etc.), fungicides, biocides, and so on.

These substances are found essentially in the finishing materials such as wood treatment products (conservation and finishing), varnishes and paint, watertightness products and joint fillers, glues, certain coatings, and certain floor coverings (carpet and vinyl for instance).

In addition, the implementation of certain materials such as insulation made from mineral products, can cause dispersion of fibres in the air that is inhaled. The European Union has classified these in category 3 (potential carcinogenic effects that have been insufficiently assessed). They can cause irritation of the skin, the eyes and the respiratory tract (proven risk) and potentially cause respiratory diseases or cancer.

The designer will consequently take care to:

- prefer surface treatments (conservation and finishing) in an aqueous phase or in dispersion, without volatile organic compounds (VOC) that can easily be maintained without harmful products;
- prefer finishing materials (floor, wall, ceiling) of natural origin that can be implemented with mechanical fastenings, without allergens, without radioactive emissions (example: certain plasters or coatings), without the presence of bio-persistent fibres (present in certain installations) that can be easily maintained without harmful products;
- limit the use of fibrous materials that have a potential risk for the person placing them and for the user;
- prefer certified materials, particularly for glues, paints, thin floor coverings (like carpet, linoleum or vinyl), wood treatment products, etc.

Construction materials

N° of Sheet:  
**F02**  
 Cross-references:  
 /  
 Appendix:  
 /

**- Reaction and sensitivity to humidity**

«Building materials, because of their components, can be a very high source of primary emissions that fall by 60 to 70% in the first six months to disappear entirely after the first year of use. Relative humidity in the indoor air increases these emissions. But humidity also causes chemical deterioration of the building material, particularly in combined action with alkaline substances (example: coverings and glues in contact with concrete). The secondary emissions produced by deterioration of the material can increase, last a very long time and have a significant effect on the quality of indoor air. The development of micro-organisms, such as mould, bacteria and mites, is favoured when the conditions food + humidity + heat are present.»

**Doctors Déoux, Guide de l'habitat sain**

The designer should therefore take care to avoid finishing materials that are sensitive to damp and could rapidly deteriorate (mould, ...) with consequences on the occupants' health;

**Example:**

- certain materials containing decomposable organic matters that provide nutrients for micro-organisms;
- certain materials with a particularly porous surface structure

**3. HELPFUL TOOLS**

**3.1. TOOLS «checklist»**

The checklist are the following:

- Norme NIBE (Netherlands)
- Green Guide to Housing Specifications (BRE, England)
- Fiches ECOBAU, ECO-DEVIS (www.ecobau.ch, Switzerland)
- Publication «Leitfaden für nachhaltiges - bauen und renovieren» (www.crte.lu, Luxembourg)
- Baubook - PassivHaus Bauteilkatalog – Ökologisch bewertete konstruktionen” (www.baubook.info, Austria)

**3.2. TOOLS «LCA» software**

The «LCA» software are the following:

- Ecobalance KBOB (www.bbl.admin.ch/kbob , Switzerland)
- Catalogue construction (www.bauteilkatalog.ch , Switzerland)
- ECO-BAT (www.ecobat.ch, Switzerland)
- ECO-SOFT (www.ibo.at, Austria)



↓↗→  
 Illustration 427, 428, 429, 430 and 431 :  
 Various Checklists for materials selecting



# REFERENCES AND ILLUSTRATIONS



References

Table of illustrations

Picture from Valérie Mahaut





---

## REFERENCES AND TABLE OF ILLUSTRATIONS

### References

---

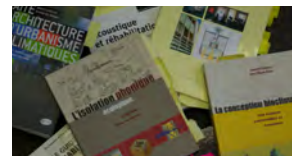

#### 1. BOOKS AND PUBLICATIONS

##### 1.1. Sustainable architecture (construction and renovation)

- A.LIEBARD, A. DEHERDE, «*Traité d'Architecture et d'Urbanisme Bioclimatique*», Editions Observ'ER, 2005, Paris, France
- B.PEUPORTIER, «*Eco-conception des bâtiments et des quartiers*», Ecole des Mines de Paris, collection Sciences de la Terre et de l'Environnement, 2008, Paris, France
- Institut Bruxellois pour la Gestion de l'Environnement (IBGE), «*Guide pour la construction et la rénovation de petits bâtiments*», éditions IBGE, 2009, Bruxelles, Belgique
- Institut Bruxellois pour la Gestion de l'Environnement (IBGE), «*Guide conseil pour la conception énergétique et durable de logements collectifs*», éditions IBGE, 2006, Bruxelles, Belgique
- Ademe, «*La qualité environnementale des Bâtiments, manuel à l'usage de la maîtrise d'ouvrage et des acteurs du bâtiment*», Ademe éditions, 2002, Paris, France
- Centre de Ressources des Technologies pour l'Environnement (CTRE), «*Guide de la construction et de la rénovation durables*», CTRE, 2008, Luxembourg

##### 1.2. Quality of outdoor spaces

- J.CASTEX, JCH. DEPAULE et Ph. PANERAI, «*Formes urbaines: de l'îlot à la barre*», éditions Dunod, 1980, Paris, France
- «*Villes d'enfants, ville d'avenir*», Commission européenne, DG Environnement, 2002, Bruxelles, Belgique
- Ademe, «*Les politiques locales de développement du vélo*», Ademe éditions, 2002, Paris, France
- Provelo asbl, «*Stationnement des vélos dans les entreprises*», document PDF, Provelo ASBL, 2006, Bruxelles, Belgique
- Centre Scientifique et Technique de la Construction (CSTC) «*Note d'information technique n°229 - Les toitures vertes*» CSTC, 2006, Bruxelles, Belgique
- N.DUNNETT, N. KINGSBURY, «*Toits et murs végétaux*», éditions du Rouergue, 2005, Rodez, France

##### 1.3. Quality of indoor air

- Drs S.et P. DEOUX, «*Le Guide de l'Habitat sain, les effets sur la santé de chaque élément du bâtiment*», éditions Medieco, 2ème éditions, 2004, Andorre
- K. DE SCHRIJVER, G. TILBORGHES, D. WILDEMEERSCH «*Wonen and gezondheid*», Ministerie van de Vlaamse Gemeenschap, Administratie Gezondheidszorg, Afdeling Preventieve en Sociale Gezondheidszorg, 2003, Bruxelles, Belgique
- World Health Organization (WHO), «*Air quality Guidelines - Europe*», updated 2005, WHO
- Données documentées sur le site de Bruxelles-Environnement : [www.bruxellesenvironnement.be](http://www.bruxellesenvironnement.be)
- F.SIMON, JM HAUGLUSTAINE, «*La ventilation et l'énergie, guide pratique pour les architectes*» Ministère de la Région Wallonne, 2001, Namur, Belgique

##### 1.4. Acoustical comfort

- Ch. SIMONIN-ADAM, «*Acoustique et réhabilitation, améliorer le confort acoustique dans l'habitat existant*», éditions Eyrolles, 3ème tirage, 2006, Paris, France
- JL. BEAUMIER, «*L'isolation phonique écologique, matériaux et mise en oeuvre*», éditions Terre Vivante, 2006, Mens, France

##### 1.5. Thermal comfort and performances of housing - Passive standard renovation

- S.COURGEY, JP. OLIVA, «*La Conception bioclimatique, des maisons confortables et économes, en neuf et en réhabilitation*», éditions Terre Vivante, 2006, Mens, France
- F.SIMON, JM HAUGLUSTAINE, «*La conception globale de l'enveloppe et l'énergie, guide pratique pour les architectes*», Ministère de la Région Wallonne, 2006, Namur, Belgique
- F.SIMON, JM HAUGLUSTAINE, «*La rénovation et l'énergie, guide pratique pour les architectes*», Ministère de la Région Wallonne, 2006, Namur, Belgique
- F.SIMON, JM HAUGLUSTAINE, «*L'isolation thermique de la façade à structure bois, guide pratique pour les architectes*», Ministère de la Région Wallonne, 2003, Namur, Belgique
- JP. OLIVA, «*L'isolation écologique, conception, matériaux et mise en oeuvre*», éditions Terre Vivante, 2ème édition, 2007, Mens, France

## References



- F.SIMON, JM HAUGLUSTAINE, «*La fenêtre et la gestion de l'énergie, guide pratique pour les architectes*», Ministère de la Région Wallonne, 2002, Namur, Belgique
- A.DEHERDE, S. REITER, «*L'éclairage naturel des bâtiments*», Ministère de la Région Wallonne, 2001, Namur, Belgique
- C.GROBE, «*Construire une maison passive, conception, physique de la construction, détails de construction, rentabilité*», éditions L'inédite, 2002, Paris, France
- A.GUERRIAT, «*La maison passive, introduction pour les architectes et les futurs maîtres d'ouvrages*», éditeur A.Guerriat, 2006, Thuin, Belgique
- *PassivHaus Bauteilkatalog – Ökologisch bewertete Konstruktionen*

### 1.6. Energy

- F.ANTONY, Ch. DURSCHNER, KH. REMMERS, «*Le Photovoltaïque pour tous, conception et réalisation d'installations*», éditions Observ'ER en association avec Solarpraxis AG, 2006, Paris, France
- F.A. PEUSER, KH REMMERS, M. SCHNAUSS, «*Installations solaires thermiques, conception et mise en oeuvre*», éditions Observ'ER en association avec Solarpraxis AG, 2005, Paris, France
- R.NOVEMBRE, J.MEINICKE, «*Le chauffage individuel au bois, comprendre, choisir et installer un chauffage écologique et performant*», éditions Observ'ER en association avec Solarpraxis AG, 2008, Paris, France
- R.CLARET, JM GROULT, «*Se chauffer autrement, chauffage solaire, chauffage au bois, pompes à chaleur, etc, Principe, intérêt et mise en oeuvre*», éditions Ulmer, collection Habitat écologique, 2008, Paris, France
- B.BERANGER, «*Les pompes à chaleur*» 2ème édition, éditions Eyrolles, 2008, Paris, France
- B.ROISIN, M. BODART, A.DENEYER, «*Guide pratique et technique à l'éclairage des logements*» Minergibat, Eclos, 2009

### 1.8. Water

- M.VAN PETEGHEM, L.DE BACKER, «*Water wegwijs voor architecten, een Handleiding voor duurzaam watergebruik in en om de particuliere woning*» Vlaamse Milieumaatschappij, 2000, Belgique
- CAGT, «*Guide de gestion des eaux pluviales et de ruissellement*», Communauté d'Agglomération du Grand Toulouse, Service Assainissement, 2006, Toulouse, France
- WWF-Belgique, «*Vivons l'eau, guide pratique pour une utilisation rationnelle de l'eau*», WWF, fichier téléchargeable, 2002, Belgique
- Ch. HEYDEN, «*Vers une gestion écologique de l'eau dans la maison*», Ecologie au quotidien asbl, 2ème édition, 2001, Havrenne, Belgique
- P. VAN DEN BOSSCHE, E. JANSSEUNE, P. THOELLEN, «*Hemel watergebruiken! Een handleiding voor gebruik van regenwater in huis*», VIBE, 2002, Antwerpen, Belgique
- S. CABRIT-LECLERC, «*Fosse septique, roseaux, bambous? Traiter écologiquement ses eaux usées*», éditions Terre Vivante, 2008, Mens, France
- V.MAHAUT, «*L'eau, le temps du paysage. Jardins d'orage et nouvelles rivières urbaines*», thèse de doctorat, août 2009, Ecole Polytechnique de Louvain, Département AUCE, Unité ARCH, Belgique

### 1.8. Waste (construction and domestic)

- S.TRACHTE, «*Gestion des déchets de chantier, opportunité pour la Région de Bruxelles-Capitale*» Travail de maîtrise, septembre 2003, Université Catholique de Louvain la Neuve, Ecole Polytechnique de Lausanne
- JM HUYGEN, «*La Poubelle et l'Architecte, vers le réemploi des matériaux*», éditions l'Impensé – Actes Sud, 2008, Arles, France

### 1.9. Construction materials

- F.KUR, «*L'habitat écologique, quels matériaux choisir?*» éditions Terre Vivante, 2001, Mens France
- J. SCHWARZ, «*L'écologie dans le bâtiment, guides comparatifs pour le choix des matériaux de construction*», Verlag Paul Haupt, 1998, Berne, Suisse
- D.KULA, E.TERNAUX, «*Materiology, l'essentiel sur les matériaux et technologies à l'usage des créateurs*», éditions Birkhauser Verlag, Frame publishers, 2009
- Publication du BRE «*Green Guide to Housing Specification*», Jane ANDERSON et Nigel HOWARD
- D.ANINK, Ch. BOONSTRA, J.MAK, «*Handbook of sustainable building, an environmental preference method for selection of materials for use in construction and refurbishment*», James & James publishers, 1993, Londres, Angleterre
- O.ARUP and PARTNERS, «*The Green Construction Handbook, A manuel for Clients and construction Professionals*», JT Design Build, 1993



## 2. WEB SITES

### 2.1. General web sites for renovation

- [www.ibgebim.be](http://www.ibgebim.be)
- [www.ademe.fr](http://www.ademe.fr)
- [www.anah.fr](http://www.anah.fr)
- [www.centrumduurzaam bouwen.ne](http://www.centrumduurzaam bouwen.ne)
- [www.cstb.fr](http://www.cstb.fr)
- [www.cstc.be](http://www.cstc.be)

### 2.2. Quality of outdoor spaces

- [www.vauban.de](http://www.vauban.de)
- [www.livablecities.org](http://www.livablecities.org)
- [www.provelo.org](http://www.provelo.org)
- [www.ibgebim.be](http://www.ibgebim.be)

### 2.3. Quality of indoor air

- [www.ecoconso.be](http://www.ecoconso.be)
- [www.sante-environnement.be](http://www.sante-environnement.be)
- [www.bruxellesenvironnement.be](http://www.bruxellesenvironnement.be)
- [www.cstb.fr](http://www.cstb.fr)
- [www.air-interieur.org](http://www.air-interieur.org)
- [www.santé-habitat.be](http://www.santé-habitat.be)

### 2.4. Acoustical comfort

- [www.anah.fr](http://www.anah.fr)

### 2.5. Thermal comfort and performances of housing and Passive standard renovation

- [www.energieplus-lesite.be](http://www.energieplus-lesite.be)
- [www.maisonpassive.be](http://www.maisonpassive.be)
- [www.lamaisonpassive.be](http://www.lamaisonpassive.be)

### 2.6. Energy

- [www.energieplus-lesite.be](http://www.energieplus-lesite.be)

### 2.6. Construction materials

- [www.ecobau.ch](http://www.ecobau.ch)
- [www.nibe.info](http://www.nibe.info)
- [www.bre.co.uk](http://www.bre.co.uk)
- [www.sia.ch](http://www.sia.ch)
- [www.vibe.be](http://www.vibe.be)
- [www.ibo.at](http://www.ibo.at)
- [www.inies.fr](http://www.inies.fr)
- [www.infolabel.be](http://www.infolabel.be)
- [www.ecolabel.be](http://www.ecolabel.be)
- [www.marque-nf.com](http://www.marque-nf.com)
- [www.natureplus.org](http://www.natureplus.org)
- [www.blauer-engel.de](http://www.blauer-engel.de)
- [www.fsc.org](http://www.fsc.org)
- [www.pefc.org](http://www.pefc.org)
- [www.svanen.nu/eng/](http://www.svanen.nu/eng/)
- [www.milieukeur.nl](http://www.milieukeur.nl)
- [www.gut-ev.de](http://www.gut-ev.de)
- [www.bauteilkatalog.ch](http://www.bauteilkatalog.ch)
- [www.catalogueconstruction.ch](http://www.catalogueconstruction.ch)

