SOLAR COMBISYSTEMS

Task 26

Industry Workshop

Delft, The Netherlands, April 2, 2001

Compiled by Werner Weiss



INTERNATIONAL ENERGY AGENCY
Solar Heating & Cooling Programme

Industry Workshop

Task 26 - Solar Combisystems



13:00 h	WELCOME ADDRESS <i>Lex Bosselaar</i>
	Solar Combisystems – market, systems and components
13:15 h	European market on thermal solar energy with a special focus on solar combi-systems <i>Werner Weiss, AEE, Gleisdorf, Austria</i>
13:35 h	Solar combisystems – a system overview <i>Jean-Marc Suter, Suter Consulting, Berne, Switzerland</i>
14:00 h	Presentations of Dutch companies - Products and plans <i>Jos Lutikholt, Atag,</i> <i>Edwin van den Tillaart, Daalderop</i>
	THERMERA® Heat transfer fluid - a natural solution for heat transfer in building technology <i>Janne Jokinen, Fortum Power and Heat, Finland</i>
	Drain back systems
14.30 h	Drain back in small systems <i>Jeroen Noij, Sustainergy, Culemborg, The Netherlands</i>
14.55 h	Drain back in large systems <i>Gerard van der Linden, ZEN, Veldhoven, The Netherlands</i>
15:20 h	COFFEE / TEA BREAK
	Legionella
15:40 h	Legionella in hot water preparation <i>Hans van Wolferen, TNO, Apeldoorn, The Netherlands</i>
16:10 h	Legionella in solar thermal systems <i>Daniël Naron, TNO, Delft, The Netherlands</i>
	Architectural integration of solar collectors
16:30 h	Roof integration of large collector areas <i>Michaela Meir, University of Oslo, Norway</i>
16:55 h	Facade integration – a new and promising opportunity for thermal solar collectors <i>Werner Weiss, AEE, Gleisdorf, Austria</i>
17:20 h	DRINK AND SNACK

Contents

EUROPEAN MARKET ON THERMAL SOLAR ENERGY WITH A SPECIAL FOCUS ON SOLAR COMBISYSTEMS	4
SOLAR COMBISYSTEMS – A SYSTEM OVERVIEW	11
A NEW GENERATION OF SOLAR COMBI SYSTEMS ATAG S-HR SOLARGASCOMBI II	12
DAALDEROP SOLAR SYSTEMS FOR DOMESTIC APPLIANCE: MONOSOLAR AND MULTISOLAR	15
THERMERA® HEAT TRANSFER FLUID - A NATURAL SOLUTION FOR HEAT TRANSFER IN BUILDING TECHNOLOGY	17
DRAIN BACK IN SMALL SYSTEMS	21
RECENT EXPERIENCES WITH LARGE SOLAR THERMAL SYSTEMS IN THE NETHERLANDS.	24
LEGIONELLA IN HOT WATER PREPARATION	30
LEGIONELLA AND SOLAR DOMESTIC HOT WATER SYSTEMS	46
ROOF INTEGRATION OF LARGE COLLECTOR AREAS - EXPERIENCES FROM NORWAY	51
FACADE INTEGRATION – A NEW AND PROMISSING OPORTUNITY FOR THERMAL SOLAR COLLECTORS	59

EUROPEAN MARKET ON THERMAL SOLAR ENERGY WITH A SPECIAL FOCUS ON SOLAR COMBISYSTEMS

Werner Weiss
 AEE – Arbeitsgemeinschaft Erneuerbare Energie
 Feldgasse 19, 8200 Gleisdorf, Austria
 Tel.: +43 3112 5886 17
 Fax: +43 3112 5886 18
 E-mail: w.weiss@aee.at, Internet: <http://www.aee.at>

1 The solar market in Europe

Since the beginning of the 90's, the European solar market has undergone a favourable development. As the figures from the DFS (German Solar Energy Association) confirm, flat plate collectors recorded an average growth of 18% between 1994 and 1999 /1/. In accordance with this 480.000 m² of collector area were erected all over Europe in 1994; by 1999, however, it had been possible to increase the collector area installed yearly to around 890,000 m² which means to almost double this within a period of five years.

At the end of 1999 a total of 8.5 million square meters of collector area were installed in Europe. In this context it is remarkable that 75% (6.4 million m²) of this collector area was installed in three countries: namely Germany, Greece and Austria.

If one relates the collector area to the area installed per thousand inhabitants in the year 1999 then with 17.5 m² Austria takes the lead over Greece with 15.2 m² and Germany with 5.1 m². Italy, Great Britain, Belgium and France come in last with less than 0.5 m² of collector area installed in 1999 per thousand inhabitants. If one considers the fact that three of the four large EU countries come in last when it comes to the dissemination of solar plants then it does not come as a surprise that solar thermal energy has been given short shrift in various EU energy programmes and that the potential of the former was rated to be „below the statistical level of perception“.

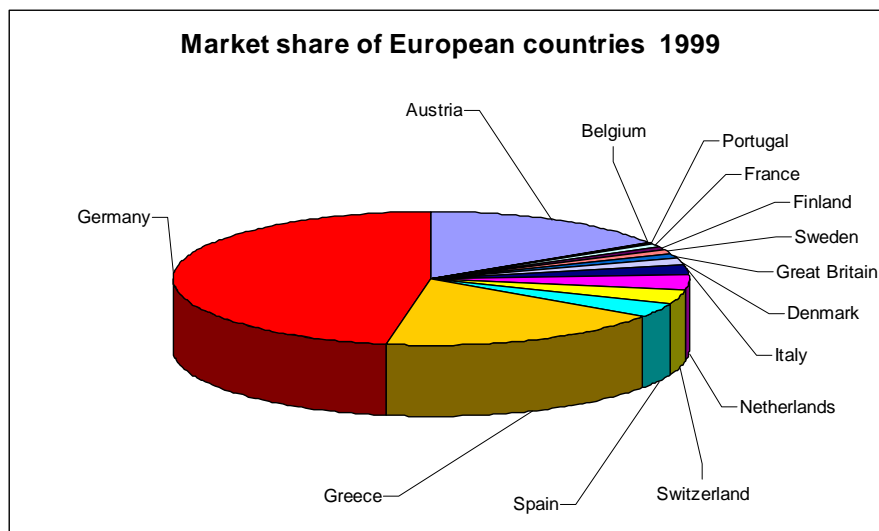

Fig. 1: Market share of individual European countries with regard to the collector area installed in 1999 (flat collectors) /1/.

The markets which underwent the greatest growth between 1994 and 1999 included Spain at 74%, the Netherlands at 38% and Germany at 34%. In the main this can be attributed to the fact that the dissemination of solar plants was still very low in these countries – compared with Greece and Austria. Apart from the lower market penetration these growth rates were also made possible as a result of deliberate state programmes of grants.

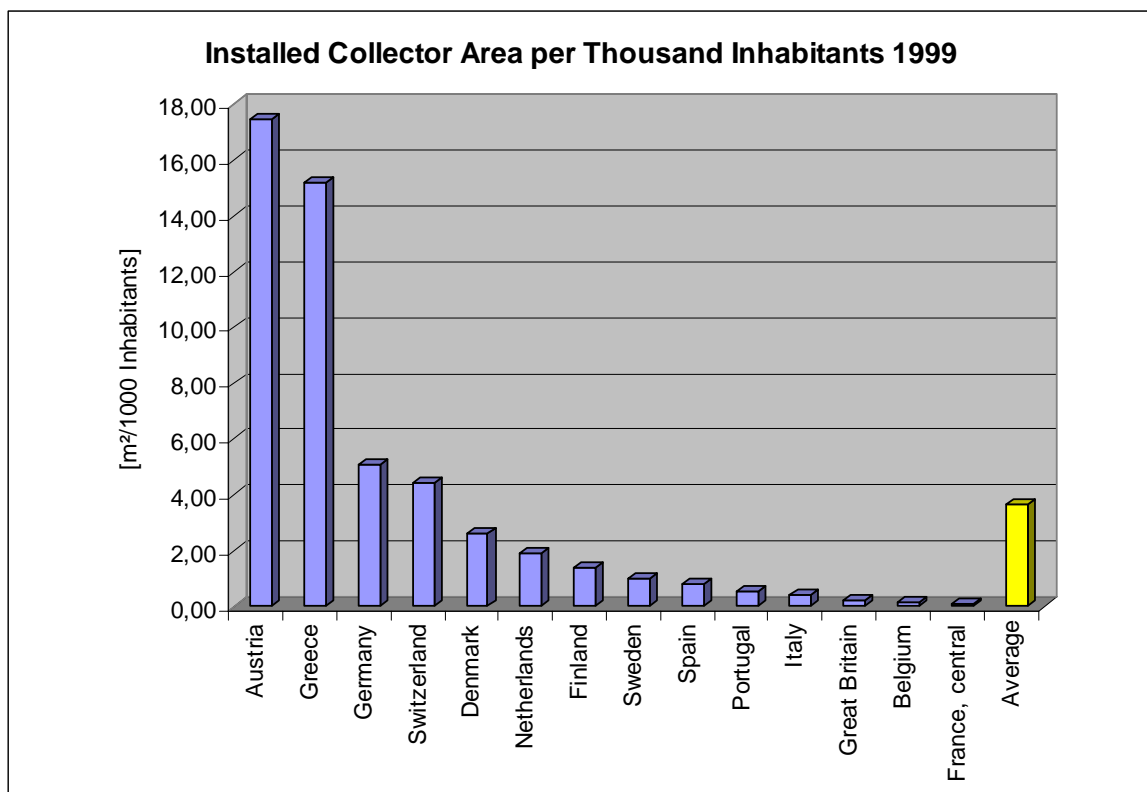

Fig. 2: Flat plate collector area per thousand inhabitants installed in the year 1999 /1/

In accordance with a survey, carried out within the framework of the Solar Heating and Cooling Programme of the IEA collector areas worth mentioning were installed outside Europe in Australia in 1998 (40,000 m²), in the USA (23,000 m²), in Mexico (11,000 m²) and in Turkey and Israel /3/

In the White Paper on renewable energy /4/ published by the European Commission in 1997 for solar thermal plants the European Commission set itself the goal of installing 100 million square meters of collector areas in member states of the Union. To achieve this ambitious goal a yearly rate of increase of 38% is required up to 2010, i.e. growth as it is at present would have to be doubled. These rates of increase can, however, only be reached if the member states and the Union support this with corresponding measures for a speedy market introduction and in the field of research and development.

2 Contribution of thermal collectors to the supply of energy in Europe

Since until now there was scarcely any information available on the contribution of solar collectors to the supply of energy, the potential of this technology was, for the greater part, underestimated. The following will illustrate the present status and potential of the solar supply of low temperature heat in Europe.

2.1 Consumption of energy in the building sector

In 1998 the final energy consumption in the building sector as a whole equalled 16,077 PJ in the member states of the Union or around 40% of the overall energy consumption in the EU /5/. Heating requirements for hot water and space heating make up for 75% of this or 12,171 PJ. 9,228 PJ is accounted for by residential buildings where most of the solar heating systems are currently installed.

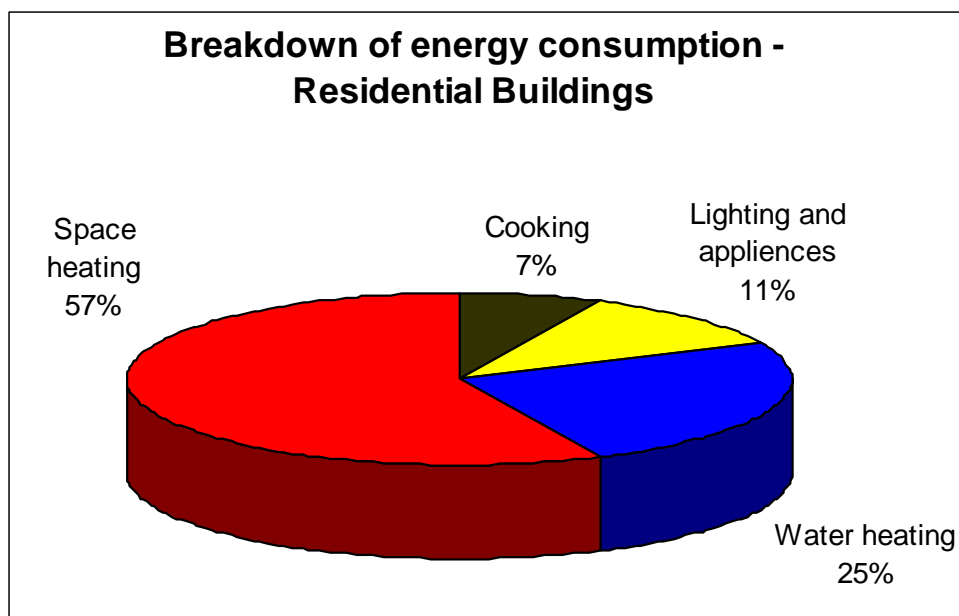

Fig. 3: Breakdown of energy consumption in residential buildings in the EU, 1998 /5/

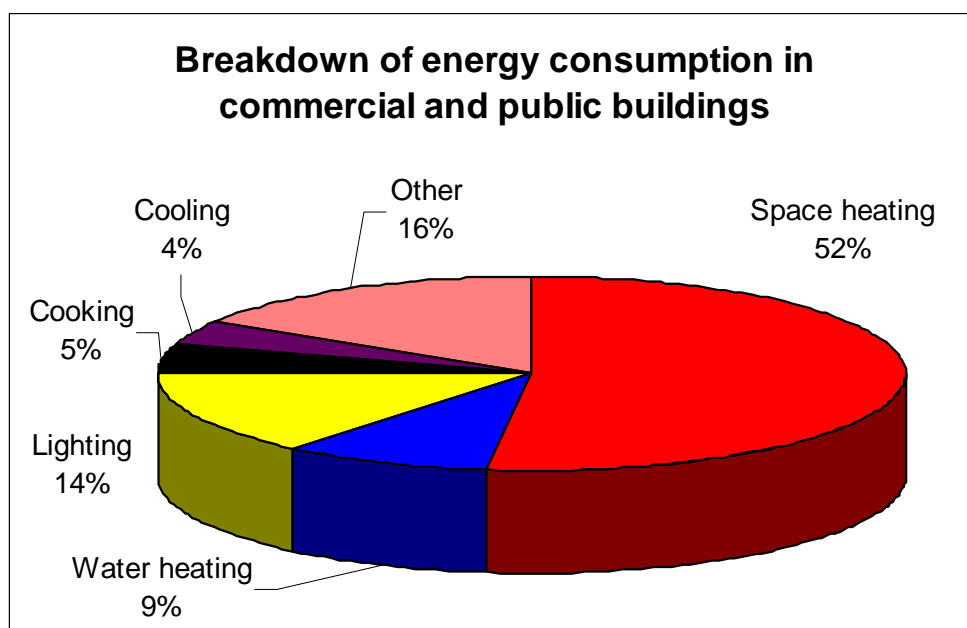

Fig. 4: Breakdown of energy consumption in commercial and public buildings in the EU, 1998 /5/

2.2 Current and medium-term energy supply with solar heating systems in Europe

If one adds the collector areas installed in the year 2000¹, to the areas depicted above for 1999 then overall around 9.5 million square meters of flat plate collectors were installed by the end of the year 2000 in Europe. These collector areas supply approximately 14 PJ of heat per year.

¹ Estimate for the year 2000 – 1 million m² based on the data available to date

If one now assumes that the final energy consumption for hot water and space heating in the EU has not risen much since 1998 then around 0.11% of the overall heat requirements for hot water and space heating was covered by solar plants in the year 2000 all over the EU.

If we assume that the goal set in the White Paper of the European Commission /4/ of 100 million m² of collector area up to the year 2010 is reached then 144 PJ of heat can be generated with this per annum. In relation to the overall hot water and space heating requirements (residential, commercial and public buildings) in 1998 1.18% could be accounted for by solar energy.

Developments in the building sector (low energy and passive energy houses) show it is possible to quickly reduce the specific heating requirements of new buildings. As studies illustrate existing buildings have medium-term potential for reduction of 20% with regard to heating energy requirement /5/.

If one takes a medium-term reduction (up to 2010) in heating requirements of 20% as a basis then the share provided by solar energy could rise in Europe to around 2% of the final energy consumption of residential buildings for hot water and space heating.

Table 1: Current and medium-term energy supply with thermal collectors in Europe and Austria.

	[PJ]	solar share [%]
Europe		
Heat requirements for hot water and space heating - EU (1998)	12.171	
Solar heat 2000 – EU	14	0,11
Solar heat 2010 – EU	144	1,18
Austria		
Heat requirements hot water and space heating - Austria (1998)	303	
Solar heat 2000 – Austria	3,22	1,06
Solar heat 2010 – Austria	12,87	4,25

2.2.1 Medium-term potential in Austria

As explained above the market in Germany, Greece and Austria is widely developed. If one now analyses the current contribution of solar energy to the supply of heat and the potential up to 2010 for Austria then it becomes clear that in the medium-term it will be possible to supply significant amounts of thermal energy to cover heat requirements in terms of solar energy.

The current (2000) solar contribution to cover the hot water and space heating requirements in Austria equals 3.22 PJ or 1.06%. I.e. Austria has already reached the value which all member states of the EU are striving for in the medium-term.

If we now assume that the average growth rates in Austria up to 2010 will be slightly below the European average at 20% since the market is already highly developed, then the collector area can be quadrupled in the next ten years.

This corresponds to an overall collector area installed in Austria of approximately 8 million m². Thus in the year 2010 around 4.25% of the overall needs for hot water and space heating can be covered by solar energy assuming that the needs remain the same.

It should be remembered at this junction that until now solar applications have concentrated almost 100% on the supply of hot water to one and several family homes. In some countries like Germany, Switzerland and Austria there has been a marked trend towards solar space heating systems for some years. In this respect significant increases are anticipated in the years to come. To date the potential for solar applications in terms of industrial low tempera-

ture energy has barely been tapped. Should it become possible to make use of this, then higher increase rates than above are possible.

2.2.2 Long-term potential in Austria

The theoretical Austrian potential equals 332,000 PJ/a. This corresponds to the average yearly global radiation on Austria as a whole. To get a realistic picture of the long-term potential only the horizontal or inclined building surfaces for the installation of the collectors are used as a basis for further observations. Around 107 km² of collector area could be installed on the 306 km² in all in accordance with /6/ with due consideration to the orientation, roof form, inclination, roof surface windows etc.. This means that approximately 193 PJ/a would be at the ready with thermal solar systems which comply with state of the art techniques.

If one also considers local and seasonal fluctuations with regard to offer and demand and the lower yields of solar space heating systems (compared to hot water systems) – as a result of limited use in certain seasons of the year – then one can reduce the technical potential on offer to the technical potential of what is actually demanded. The technical demand potential is the amount of energy which it would be possible to integrate in the energy system.

Table 2: Technical Demand Potential – solar low temperature energy (TDP) on the basis of the present state of the art; i.e. without consideration of future developments in the standard of buildings or solar heating systems /6/.

	Total ^{*)} [PJ]	TDP [PJ]	TDP [%]
Hot water (households, industry and public facilities)	45	25	56
Space heating	258	32	12,5
Process heat < 100 °C	21	8	38

^{*)} Basis: final energy consumption 1998

Neubart und Kaltschmitt /6/ record the technical demand potential for hot water prepared by solar thermal systems as 25 PJ/a, and 32 PJ/a for space heating – which is subject to more considerable restrictions when it comes to the integration into the energy system – and 8 PJ/a for low temperature process heat. Table 2 provides an overview of the long-term potential of solar low temperature heat on the basis of the state of the art of engineering, i.e. without consideration of future developments in the standard of buildings or solar heating systems.

3 Solar space heating – future potential in Europe

Experience with solar plants for the preparation of hot water for domestic use shows that these are technically sophisticated and reliable.

In parallel fashion to the increase in the dissemination of solar hot water plants, systems have been developed and tested for solar space heating as of 1990. The market share of these combisystems (hot water and space heating) in terms of the collector area installed equalled 50% in Austria in 1998 /2/. Similar rates of increase have been recorded in other European countries.

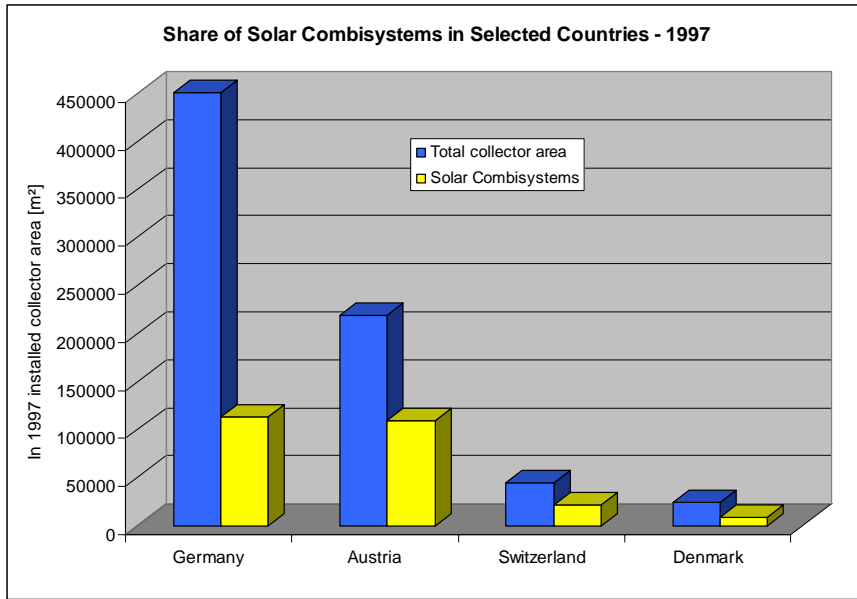

Fig. 5: Total installed collector area and share of collector area installed in solar combi-systems for space heating in selected countries /7/

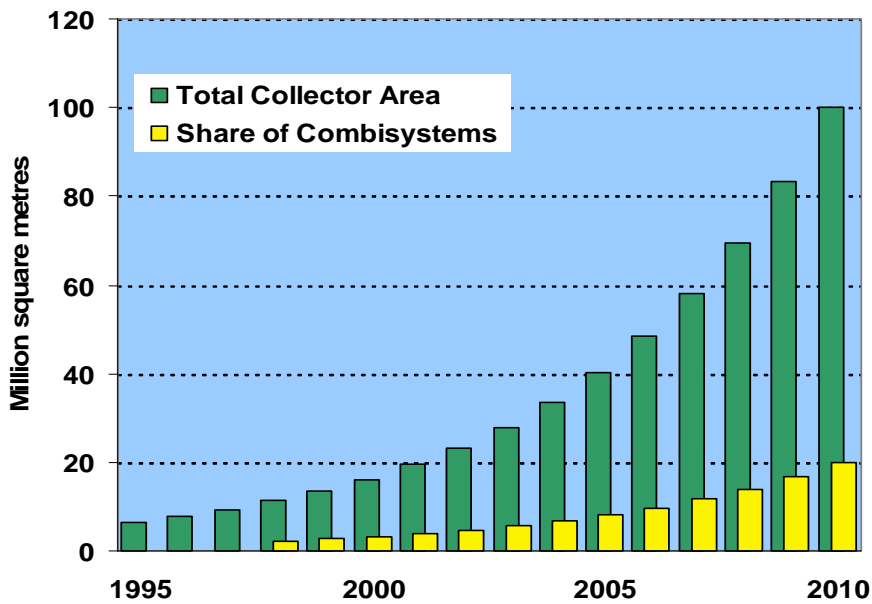

Fig. 6: Increase rates forecast by the European Commission with thermal solar collectors and possible market share for solar combisystems by the year 2010 /6/.

If one uses the yearly growth rates anticipated by the European Commission in its White Paper with regard to thermal collectors as a basis then making a conservative guess one can assume that at least 20% of the installed collector area will be accounted for by solar combi-systems. I.e. that on average 120,000 solar combisystems will be installed in member states of the EU in the next ten years with an overall collector area of 1.9 million m².

4 Literature list:

- /1/ Stryi-Hipp, G: Der Europäische Solarthermie-Markt, Tagungsband: Gleisdorf Solar 2000, Gleisdorf 2000
- /2/ Faninger, G: Der Solarmarkt in Österreich 1999, Wien 2000
- /3/ Internal Paper, IEA, Solar Heating and Cooling Programme, 2000
- /4/ European Commission: Energy For the Future: Renewable Sources of Energy – White Paper for a Community Strategy and Action Plan COM(97)599 of 6.11.1997
- /5/ European Commission: Green Paper – towards a european strategy for the security of energy supply, technical document, Brussels, 2000
- /6/ Neubarth, J., Kaltschmitt, M (Hrsg.): Erneuerbare Energien in Österreich, Wien, 2000
- /7/ Suter, J.M., Letz, T., Weiss, W.: Solar Combisystems – Overview 2000, IEA-SHC Task 26, Berne 2000

SOLAR COMBISYSTEMS – A SYSTEM OVERVIEW

Jean-Marc Suter
Suter Consulting
P.O. Box 130, 3000 Bern 16, Switzerland
Tel.: +41 – 31 – 350 00 04
Fax: +41 – 31 – 352 77 56
e-mail: suter@email.ch

The contribution of Mr. Jean-Marc Suter is a summary of the coloured booklet “IEA SHC – Task 26, Solar Combisystems”.

This booklet is available from the national contact persons of the “IEA SHC – Task 26” and from the web (<http://www.iea-shc.org/task26/index.html>).

A NEW GENERATION OF SOLAR COMBI SYSTEMS ATAG S-HR SOLARGASCOMBI II

J.J.M. Lutikholt
ATAG Verwarming bv
P.O. Box 105, 7130 AC Lichtenvoorde
Phone: +31 544 391777
Fax: +31 544 393398
E-mail: j.lutikholt@ATAGverwarming.com
Site: www.ATAGverwarming.com

Abstract

One of the first devices which combines solar energy and natural gas in one single appliance for domestic hot water and for central heating is the ATAG SolarGasCombi^I system from ATAG Verwarming. The research started in 1994. The market introduction of the ATAG SolarGasCombi VR (=improved efficiency class) was in 1996. The ATAG SolarGasCombi HR (=high efficiency class, condensing) was introduced in 1997. This year a new generation of ATAG SolarGasCombi will be introduced, the ATAG S-HR SolarGasCombi^{II}.

Based on the experience of the first generation and the same functionality the second generation is developed. In this system the gas burner is not anymore situated in the storage tank, but separate in the high-efficient ATAG condensing boiler. The ATAG S-HR SolarGasCombi^{II} is a new compact-system, built up with components well known and proven quality. The properties are: improved efficiency, improved comfort for central heating and domestic hot water, and applicable for 'bad' fresh water qualities. The ATAG S-HR SolarGasCombi^{II} will become available in different input capacities, storage tank contents and will be applicable also for glycol absorber systems.

ATAG SolarGasCombi^I system

The SolarGasCombi VR (=improved efficiency class, input 15 kW, H_s) was developed and measured in the factory of Luigjes Zonne Energie in 1994. The Solar Gas Combi VR system is a solar heating system for domestic hot water and central heating and consists of two parts, namely:

- The solar absorbers (generally $<5 \text{ m}^2$)
- The storage tank (240 litre) with integrated gas burner, heat exchangers, pumps and controls.

In the lower part of the storage tank the heat exchanger (double shell) of the solar circuit is situated. The gas burner is approximately in the centre of the storage tank, which contains domestic water. The heat exchanger in the upper part of the storage tank is connected with the floor- or radiator heating. The gas burner keeps the temperature in the upper part of the storage tank as high up as required for both heating and domestic hot water demands with a specially developed control. In figure 1 a diagram of the system is shown. The market introduction was in 1996.

In 1997 ATAG Verwarming took over Luigjes Zonne Energie, the modulating SolarGasCombi HR (=high efficiency class, condensing) was introduced on the market, see figure 2. The nominal input is 15 or 18 kW (H_s), the minimum input of the modulation range is 6 kW. Besides the improved efficiency, it provides a high comfort-level for domestic hot water, the emissions of CO and NO_x were reduced significantly, the user- and service- friendly is improved. For large-scale projects a storage tank of 650 litre is available.

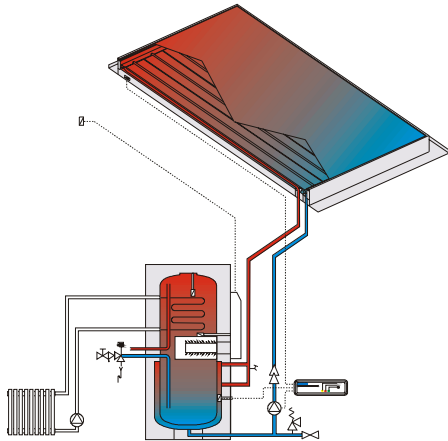

Figure 1: diagram of ATAG SolarGasCombi^I



Figure 2: ATAG SolarGasCombi^I

ATAG S-HR SolarGasCombi^{II} system

Based on the same functionality the second generation of SolarGasCombi system is developed with a wider applicability and with quality proven ATAG components. See figure 3 and 4.

Instead of the double shell of the first generation, a coil heat exchanger is situated in the lower part of the storage tank. Due to the corrosive damages caused by fresh water qualities in some regions in the Netherlands the internal concept of the device has been changed. In the second generation the gas burner is not situated in the 200 litre storage tank, but separate in an ATAG condensing boiler. The boiler is connected inside the device. The ATAG S-HR SolarGasCombi^{II} profits on this way of all the benefits of the well-known and proven quality of the ATAG condensing boiler. For the central heating the boiler control regulates with the mixing valve the use of the heat exchanger in the middle of the tank. It will extract solar heat out of the tank when the return temperature of the central heating is lower than the storage temperature at the level of this heat exchanger. If necessary the mixing valve will mix the central heating water the required (low) temperature. This is very useful in the case of low temperature heating and/or use of the integrated outdoor temperature control. If the amount of available solar heat is insufficient the ATAG condensing boiler will heat the flow to the required temperature. For the domestic hot water the upper coil in the storage tank is used to heat the domestic water to the required temperature.

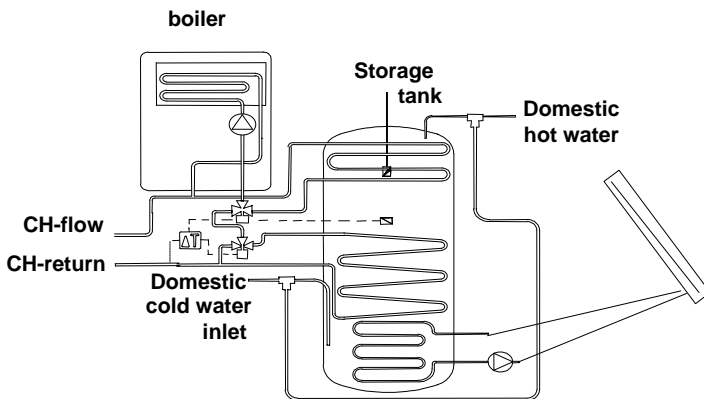

Figure 3: Diagram of ATAG S-HR SolarGasCombi^{II}

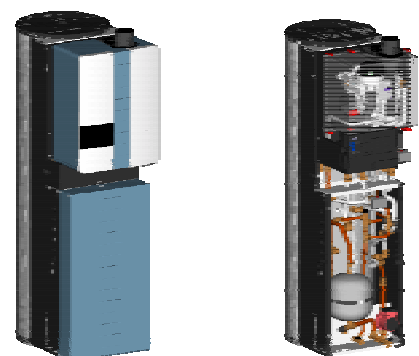

Figure 4: ATAG S-HR So-

The following advantages for installer, user and environment are achieved:

- Easier to handle and to install because of 2 colli system: the condensing boiler and the storage tank with the other components
- Simple and quick to install and to service: all necessary components are included (controls, drain-back, mixing valve for central heating, filter, water safety valves and controls, etc.). The system is easy to understand by the installer because of the well known ATAG condensing boiler
- Built-in drain-back system suitable up to 6 m² solar absorbers
- Applicable for all situations in the Netherlands and abroad (for quite differing local water qualities)
- Improved central heating energy efficiency (GASKEUR-label central heating HR107 class, efficiencies up to 109 %) by ATAG condensing boiler
- Improved comfort for central heating: modulation range of 1:6 and the extra mixing valve to achieve the required (low) flow temperature
- Improved comfort for domestic hot water: There are 15, 24 and 35 kW boilers available
- Reduced emissions of CO and NO_x
- Optional: A digital communicating room thermostat and zone controls with a simple user-interface. There will be information available about the solar system
- Proved ATAG reliability: Almost all components are existing and already used in high quantities over many years with a proven quality
- Improved cost/specification ratio because of the use of standard ATAG components in high quantities
- Range of devices available: Load inputs 15, 24 and 35 kW with a 200 litre storage tank. Later, it will be expanded to other storage tanks contents and applied for glycol absorber systems.

The introduction of the ATAG S-HR SolarGasCombi^{II} can be expected this year.

Conclusion

ATAG Verwarming has built up experience more than 7 years with the first generation of ATAG Solar Gas Combi. Based on these experiences and the same functionality of the first generation a renewed high-quality generation is developed. Unless it is a new system, it contains many well-known and proven components. ATAG Solar Gas Combi^{II} is ready for the next years, it will become a powerful and successful energy-efficient product with the use of free solar energy.

DAALDEROP SOLAR SYSTEMS FOR DOMESTIC APPLIANCE: MONOSOLAR AND MULTISOLAR

Edwin van den Tillaart
Daalderop B.V., product development dept.
P.O. Box 7, 4000 AA Tiel
The Netherlands
Tel: +31 344 636 592
Fax: +31 344 636 589
E-mail: development@daalderop.nl

Abstract

Daalderop B.V. was constituted in 1880 and has become a well known manufacturer of copper storage boilers through the years. The current location of the company is Tiel (NL) where it provides work to approximately 150 employees. Since 1994, Daalderop also manufactures a gas appliance called HR GasCombi. This compact appliance provides space heating and has a 80 litre warm water storage. Since 1999, Daalderop started to build solar storage systems with a content of 100 litres called the MonoSolar. This finally resulted in the MultiSolar which provides heat from gas and the sun for heating the house and consumption water. This system is being sold in The Netherlands since 2000.

1. MonoSolar

Daalderop's MonoSolar is built up of a 100 litre steel storage tank with a 5 litre copper heat exchanger. The storage tank contains collector-water which is heated by the solar collector. The storage tank is filled with water without any additions and makes a closed circuit together with the collector. The MonoSolar is a drainback system with its drainback volume integrated in the top of the storage tank. This also works as expansion volume.

Depending on the absorber temperature, the circulation pump is modulated from 20 litres per hour up to 110 litres per hour with a collector area of 2,76 m². The MonoSolar is designed to work as a "low flow" system with stratified storage. Therefore the temperature in the "hot-top" becomes 60°C or more in very little time. Together with the little volume of consumption water the health risks are minimised. In practice during short draw-offs the gas-fired after-heater will not ignite due to an immediate temperature of 60°C or more. The number of starts is therefore reduced and reciprocating behaviour of the auxiliary heater is avoided.

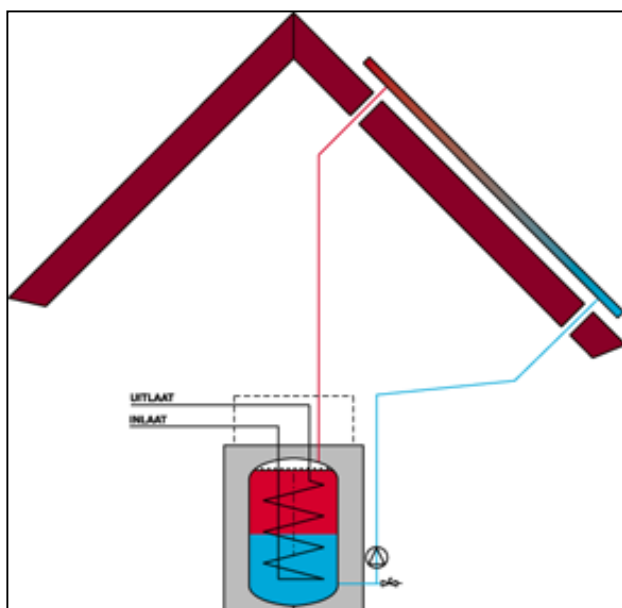

2. MultiSolar

Daalderop's MultiSolar is basically constructed from a MonoSolar with a gas-fired boiler placed on top of it. The upper module consists of a 80 litre boiler, a heating water circuit and a low NO_x burner. This all is built together in a concentric construction and results in a high efficiency for both consumption water and space heating.

The 5 litre copper heat exchanger in the lower module contains consumption water and is connected to the 80 litre boiler of the upper module. During hot water draw-off, tap water flows through the heat exchanger into the boiler. The 80 litre storage is kept at a minimum of 60°C and will not cool down as long as temperature in the top of the lower module is higher than about 65°C. In that case (and if there is no tap water draw-off), a thermosiphon circulation will start. Colder water in the upper module is exchanged by warmer water from the heat exchanger in the lower module. Reverse flow is prevented by a non-reverse valve. Temperature in the upper module can rise up to 85 – 90°C.

The 80 litre copper storage of consumption water has a double-walled separation from the space heating water. The low NO_x burner is placed in an aluminium heat exchanger where flue gasses are cooled down by space heating water that flows through channels in the heat exchanger. When the boiler is warmed up, the space heating water circulates internally and reaches a supply temperature up to 90°C. Heat transfer through the double walled separation to the consumption water is 17 kW.

When there is a space heating demand, most conventional appliances will immediately ignite the burner. The MultiSolar will first start to pump for a very short time and only ignite when the supply temperature is below its set point. This set point is between 60 and 90°C or is calculated from temperatures of the outdoor and return sensor in case of a weather dependant control.

If the return temperature of the space heating circuit is lower than the boiler temperature, there will be a heat flow from the boiler to the space heating circuit. With this additional heat, supply temperature for space heating will be raised. As long as the supply temperature is higher than its setpoint, burner ignition is suppressed.

In this way the MultiSolar utilises solar energy directly for consumption water and indirectly for space heating. Heating systems with a low supply and return temperatures will therefore receive a larger contribution of solar energy.

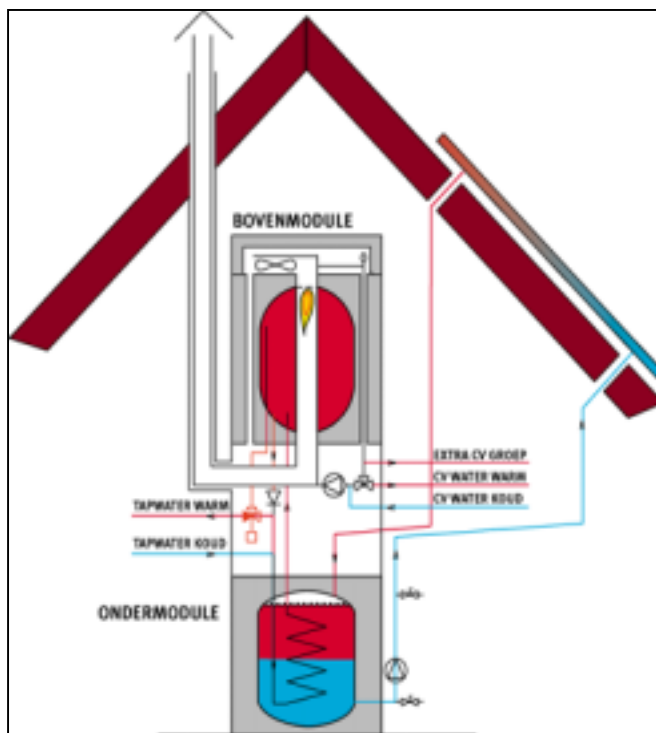

THERMERA® HEAT TRANSFER FLUID - A NATURAL SOLUTION FOR HEAT TRANSFER IN BUILDING TECHNOLOGY

Janne Jokinen
Fortum Power and Heat
POB 20, 00048 FORTUM, Finland
Tel.: +358 10 4533306
Fax.: +358 10 4533310
Mobile: +358 50 4533306
E-mail: Janne.Jokinen@fortum.com



THERMERA®

Heat transfer fluid

A natural solution for heat transfer in building technology

Fortum Power and Heat Oy

THERMERA® heat transfer fluid

- The main ingredient of Thermera is fully natural Betaine
- The heat transfer capability of Thermera equals those of traditional glycols
- Thermera has excellent low temperature flow dynamics and corrosion inhibition capability
- The life-cycle cost of Thermera use is very competitive with respective costs of glycol use

Fortum Power and Heat Oy



THERMERA[®] heat transfer fluid

- Betaine, trimethylglycine is
 - Non-toxic
 - Environmentally friendly
 - Completely water soluble
 - Cost efficiently disposable
- Betaine is acquired from the refining process of sugar beet
- Other uses of Betaine include animal feed additive and the cosmetics industry



Fortum Power and Heat Oy



BETAINE, trimethylglycine

Sugar beet refining process

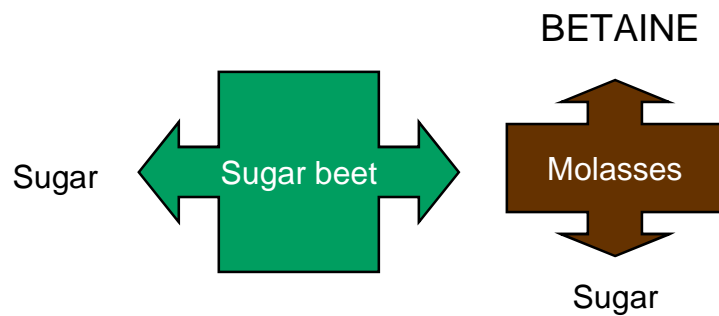

Fortum Power and Heat Oy



THERMERA[®] heat transfer fluid

- **Technical applicability has been verified in building systems and industrial heat transfer**
- **Non-toxicity broadens area of use**
- **Verified temperature range in building systems use is
- 50 °C... +110 °C**
- **Thermera is always shipped as a ready-to-use fluid fitted to customer needs**

Fortum Power and Heat Oy



THERMERA[®] heat transfer fluid **- a solution to many old problems**

There are many problems in glycol use:

- **toxicity, which leads to multiple problems in use, transport and storage**
- **glycols are not water soluble, but only mixable, in effect glycol based fluids are never homogenous**
- **heat transfer capability declines in low temperatures**
- **Disposing of glycols is very expensive (they are treated as toxic waste)**

Thermera can eradicate all these problems !

Fortum Power and Heat Oy

THERMERA® -15

- Suitable for heat transfer applications in the temperature range of -15 °C ... +110°C (fluid temperature)

Ingredients of Thermera -15 :

- betaine (trimethylglycine) app. 30 w-%
- ion-changed water app. 69 %
- corrosion inhibitor, less than 1 %
- fragrance, less than 1 %



Fortum Power and Heat Oy

THERMERA® -35

- Suitable for heat transfer applications in the temperature range of -35 °C ... +110 °C (fluid temperature)

Ingredients of Thermera -35 :

- betaine (trimethylglycine) app. 45 w-%
- ion-changed water app. 54 %
- corrosion inhibitor, less than 1 %
- fragrance, less than 1 %



Fortum Power and Heat Oy

THERMERA® heat transfer fluid - production

Production and logistics are controlled by the Fortum ISO 9001 certified quality management system

Continuous

- Quality control
- Sampling
- Lot marking
- Calibration



Fortum Power and Heat Oy

DRAIN BACK IN SMALL SYSTEMS

Mr. Jeroen Noij
Sustainergy
Houtmolenstraat 48, Culemborg
The Netherlands
Tel: +31 345 510626
Fax: +31 20 8765352
E-mail: info@sustainergy.nl
Internet : www.sustainergy.nl

Abstract

Flat plate solar collectors may be exposed to temperatures below 0°C under Northern and Mid European weather conditions. If water is used as collector fluid, ice formation may cause damage to the absorber. Due to expansion of ice and compression of the fluid, the absorber is exposed to high mechanical stresses. In most cases, these high stresses lead to plastic deformation and finally leakage of the absorber. Several methods are used to protect thermal solar collectors against frost damage. One method is lowering the freezing point of the medium by adding glycol to the water. Another method is drainback technology. It is used in 80 to 90% of the installed systems on the Dutch market. Four drainback systems on this market are presented in this paper.

1. Introduction

By lowering the freezing point of the collector fluid, the solar collector is protected during cold periods. However, additions normally lead to higher installation costs, lower heat transfer and increase of maintenance. Another method is draining the collector in periods in which damage may arise. This method is based on draining the water from the tilted collector using the gravitational force and filling it with air from the top. By replacing the water in the collector by air, ice cannot be formed in the absorber and damage is therefore avoided. Although this method is simple and cheap, draining a collector requires special qualities in the hydraulic design. One of the most important features is that all water can drain out downwards. This means that all tubes must be tilted to the lowest connection. Several systems have been designed and used on the Dutch market for many years.

2. Domestic drainback designs

Drainback systems are protected by the gravitational force. They contain a drainback volume that is filled with air when the system is running. In domestic systems, this volume is normally integrated in the storage tank. When the pump in the solar collector circuit stops, water drains from the bottom of the collector to the drainback volume due to gravitation. At the same moment, the air from this volume flows upwards to the top of the collector. This process stops when the water level in both pipelines are equal. At that moment, the collector must be fully filled with air. The process can be negatively influenced if a part of the hydraulic circuit contains a sag. In this situation, the height of the sag creates an increased level at the lower part of the collector. In critical installations this may lead to frost damage after all. In figure 1 an overview of four different systems currently on the Dutch market is given.

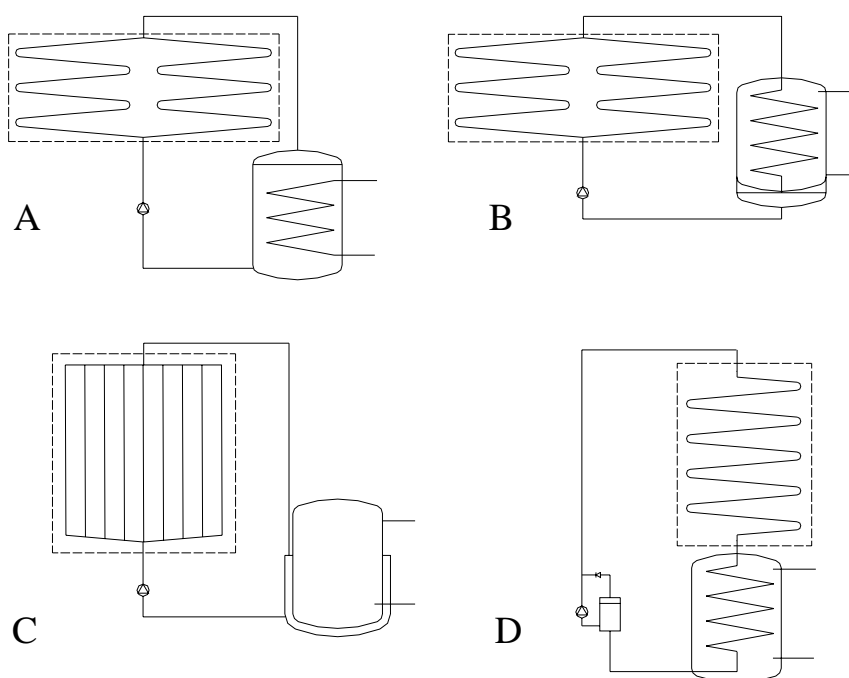

Fig. 1: Domestic drainback systems on the current Dutch market

In system A, the storage tank also functions as drainback vessel. The water that flows through the collector is stored in the tank directly. The drainback volume is determined by the expansion of the water, since expansion may lead to an increase of the water volume with 2% within the storage temperature range. The heat is extracted from the storage tank during a domestic hot water tapping by means of an integrated heat exchanger coil. Since the drainback level is located at the top of the tank, the concept requires that the collector as a whole must be installed higher than the top of the storage tank. Since the pressure of the applied pump is limited, the difference in height between tank and collector cannot exceed about 7 meters. For energetic reasons, the power of the pump is reduced when the collector circuit has been filled. The collector used contains of two tilted serpentine tube absorbers.

The drainback vessel in system B is constructed at the bottom of the sanitary water storage tank. The drainback level is therefore also located at the bottom of this tank. It consists of an extra tank bottom. Since the lowest point of the collector must be above the drainback level, the collector can be installed at a relatively low position. Therefore the tank in this system can be mounted to the wall in the attic, next to the auxiliary heater. In this system the sanitary water is being pre-heated when the collector is running. The spiral heat exchanger in the tank therefore is dimensioned for lower heat transfer. Also in this system, the pump is modulating when the system starts operating. The same collector as in system A is used.

System C contains a double wall sanitary storage tank. The gap between the walls is used as drainback vessel. The drainback level of this system is approximately at the middle of the tank height. The tank stands on the floor. The collector is of the headers and risers type. Since the collector may be mounted a little oblique in practice, the lower header is V-shaped minimizing the risk of remaining water.

In System D, a low flow displacement pump is applied to circulate the water through the collector. Usage of this type of pump has the advantage that the collector can be mounted at a higher level. However, since water cannot flow through this pump when it is not running, a bypass has been made to relieve the air out of the drainback vessel. A one-way valve located in this bypass line automatically opens when the pump stops. In contrast with the other systems, the water in the collector flows downwards both when the pump is running and

when the system drains back. The heat is transferred to the sanitary water by means of a heat exchanger coil. The collector contains a single serpentine absorber, that is constructed under a tilted angle. The pump does not modulate since it already has a very low electricity use.

Installation and maintenance

For drainback systems, it is of crucial importance that all the collector fluid drains from the collector and connections that are located in freezing atmosphere. Therefore, the top of the collector must be supplied with air. For this reason the pipelines have to be mounted under a tilted angle rising from the storage tank to the collector. It is also very important that the tilt angle remains during the life cycle of the system and therefore the pipelines must be mounted firmly.

Due to the fact that only water is used as heat transfer medium, the fluid does not have to be refilled periodically. The only maintenance that is required is a periodic check of the water level in the system.

Link to IEA 26

As previously mentioned, drainback technology is applied on the Dutch market successfully for many years. Therefore Dutch solar combisystems are also equipped with this technology. Although solar combisystems normally use large collector areas, the same techniques are applied.

RECENT EXPERIENCES WITH LARGE SOLAR THERMAL SYSTEMS IN THE NETHERLANDS.

T.P.Bokhoven, ing J.van Dam, P.Kratz
ZEN-international bv
Lage Gouwe 198 d
2801 LM GOUDA
The Netherlands
Tel: +31 182 599899
Fax: +31 182 599 127
e-mail: 101520.1004@compuserve.com

Abstract

Since 1995 two large solar thermal systems (1200 and 2400 m²) were realized in the Netherlands for industrial purposes. It is expected that large solar systems will be used more often in the coming years. For that reason and for the benefit of successful solar projects two important practical experiences with these large systems are reported.

In 1995/1996 a system has been constructed in Lisse for the purpose of agricultural drying and conditioning, consisting of a 1200 m² (high performance) flat plate collector array and a 1000 m³ water storage. The storage has been constructed as a foundation of a warehouse building and is situated below groundwater-level. The combination of these two conditions, in relation with the other storage parameters have given ground for many extra design considerations compared to other underground storage's.

Special details had to be designed for these specific conditions for leakage's (in/out the store), anti-floating measures and high temperature resistant under-water insulation. The lessons learned in this project can be of value for those considering the construction of this kind of underground storage's.

In 1996/1997 a 2400 m² system was realized in Breda at a confectionery factory (van Melle) in which for the first time the drain-back-concept was used on such a scale. The various design characteristics for drain-back systems, as they were already known for two decades in small domestic hot water systems, were upgraded to a "super drain-back" system. The scale of the project further emphasized the advantages of this concept in cost (both operational and investment), performance and safety. However the size of the systems also brought some unexpected side-effects which should be taken into account for future designs.

1 Lessons learned in relation to a medium-sized seasonal storage in groundwater conditions.

1.1 Introduction

The Lisse project was constructed as part of IEA-Task 14 Large Systems Group (IEA-Solar Heating and Cooling program). The overall results of the project have been monitored and were reported in the final report of Task 14, Large System Working Group. The project received financial support from the European Union under the Thermie-program and from Novem (Netherlands Agency for Energy and the Environment).

The system delivers heat for an agricultural drying and conditioning process with two peak loads in the summer (for bulb-drying) and a moderate load during the autumn and winter season (for bulb-conditioning).

The calculated storage capacity for this application was appr. 1000 m³. This storage was fed with solar heat from a 1200 m² collector array, mounted on the roof of the buildings. The storage had to be located under a new to build warehouse. Groundwater level on site nor-

ally varies between 0,5 – 0,8 meter below surface with possible peak conditions of +/- 0,5 meter. The storage dimensions (outside) were designed: 20 x 20 x 3,5 m1.

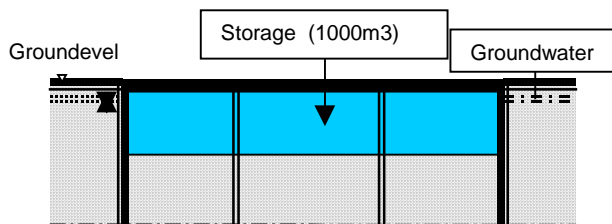

Fig.1 Underwater Storage

1.2 Requirements

The storage had to meet a wide variety of requirements.

- Temperatures in the storage were calculated to range between 25° and 80° C.
- The insulation material should maintain its insulation value (temperature, pressure and water)
- The construction should prevent “floating” of the storage when empty or when high groundwater levels occur
- The construction must be used as foundation and floor for a warehouse.
- Minimize thermal bridges

To meet all of these requirements in the same construction determined the complexity of the project. It is, for example, not complicated to seek out insulation material which will remain stable for a longer period; however, it becomes complex if the material has to be stable at variable temperatures under water. It is also relatively simple to make the construction strong enough, in order to meet the criteria for the foundation for the future warehouse, but it becomes almost impossible to meet the criteria to prevent thermal bridges if we need concrete piling for the support construction.

1.3 Original Design

The first design of the storage was based on a steelsheet-piling construction to serve as a ground support and water barrier during construction and as outer wall in the finished situation. Concrete pilings for the foundation of the warehouse were needed. The (low) construction floor of the storage was designed to fix the lower part of the side walls and the concrete pilings. In this first design the insulation was “sandwiched” between the (watertight) steel wall and a HDPE-foil. To guarantee that the insulation material was to remain dry at all times a pumping device was constructed. The HDPE-foil was guaranteed to be 100% watertight. Based on that assumption the use of open-cell polystyrene insulation material could be considered. This material can stand the maximum temperatures of 80° C and the pressure in the tank, while it has an attractive price.

To prevent the storage from “floating” a relief valve in the bottom of the storage was used. This valve will open once the upward groundwater pressure would lift the construction (under the circumstances that the groundwater level would reach a higher level than the water level in the tank).

1.4 Construction experience

Based on this original design the construction was carried out. The construction elements like the piling, the concrete floor and the concrete beams to be used both as support for the ceiling of the storage as well as the foundation of the building were put in place. After that a steel “boxing” construction was applied. This implied a steel lining to the walls and the bottom

of the storage. This created a watertight construction. The insulation material was put in place and the pressure relieve valve was fixed. Before the HDPE lining was applied a safety pumping device was applied for the circumstances that minor leakage should occur.

Once the storage was filled with water, it appeared that the HDPE lining was not watertight. Even after thorough inspection and repairs the lining was leaking. For that reason this insulated sandwich construction was abandoned.

Other special attention had to be given to the connections were the concrete piling perforated the concrete floor. Between the steel "boxing" and the pilings a special "swelling"-rubber was applied.

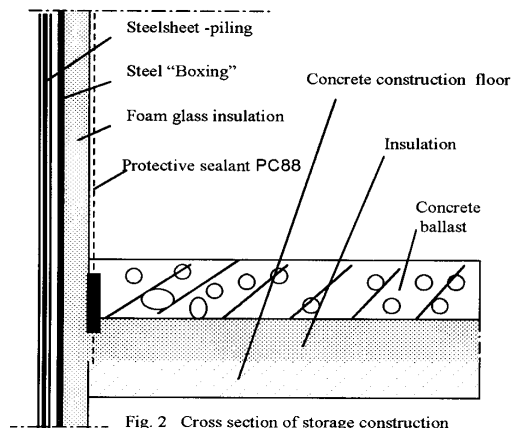

Fig. 2: Cross section of storage construction

1.5 Underwater insulation

Based on the negative experience with the HDPE-liner a choice was made to use a water resistant insulation material. A selection of closed cell foams was reviewed. The only product which passed all the criteria turned to be foam glass. This material has a high temperature resistance and will maintain stable over time and under pressure. The only disadvantage of the product is that water of appr. 80° C will have an etching effect on the foam glass cellular walls. This etching can eventually break the cellular wall and start a chain reaction, with an end result of an open cell foam structure (with low insulation value). To protect the foam glass a special protective rubber-like sealant was applied on the foam glass facing the 80° C water (PC 88, Corning). Through this material the cellular walls are protected for etching and the material will remain stable.



1.6 Lessons learned in relation to an underwater storage

The construction of an under (ground) water heat storage needs special attention for some critical parameters.

1. A pressure relief valve must be applied in order to prevent the storage to float.

2. If it cannot be avoided that pilings perforate the construction a good solution can be found to use special swelling rubbers, which are also used for tunnel construction
3. A steel "boxing" construction is both practical and relative cheap. Corrosion protection at the "insulation" side is not needed if foam glass insulation is fixed at the inside.
4. Foam glass with a protective sealant (PC88) is a stable insulation material for this application since it is high temperature resistant and can stand relatively high pressure.
5. The use of foam glass allows an insulation at the inside of the storage, thus reducing thermal bridges to a minimum.

2 Drain back as a reliable system approach for large solar thermal systems.

2.1 Drain-back in general

In the Netherlands drain-back is for many years the predominant systems approach. In the earlier years of solar energy the drinking water regulation prevented the use of additives in a collector loop for overheating and/or freezing protection. As an alternative, drain back systems are used for typical domestic solar hot water systems. At the end of 1998 appr. 35000 drain-back systems are installed in The Netherlands alone.

In general drain-back systems have some advantages over systems with anti freeze additives. The collectors will be empty under freezing or overheating conditions. The heat transfer medium can be normal drinking water, therefore maintenance to the medium is superfluous. Overheating protection to the system is not needed (no flushing or cooling). These advantages will typically result in a cheaper system design, simple control strategy, low maintenance cost and high level of safety and durability.

Drain-back systems are inherently safe; if problems occur with the electricity supply or the pumps fails, the system is automatically drained. The max. temperature set point of the storage is in this way also a protection for malfunctions at the secondary circuit.

To install a drain-back system special attention should be given to the collectors (should be qualified to resist long time stagnation, and should drain completely), the piping work (all piping under a slope), the control strategy (delta T, max. temperature and allow for some time to fill the system) and in general to keep the collector loop air tight. However these typical drain-back installation aspects are relatively simple, once carried out with professional care.



In 1996/1997 a 2400 m² system was realized in Breda-NL in which the drain-back-concept was introduced on such a scale. The project was realized as a solar plant for industrial heat for a confectionery factory. The various design characteristics for drain-back systems, as used for small domestic hot water systems, were upgraded to a "super drain-back" system. The system load consisted of a daily use of 125.000 L hot water of 65 °C (26000 MJ/day). The factory is in operation 5 days a week. The solar contribution to cover the load was designed to meet 45%. This implied an almost full 100% contribution of the solar system in summer.

Designed for these criteria, the system has the same proportion as a standard small domestic hot water system in the Netherlands (100 l / 2,75 m²) only some 1000 times larger (95 m³/2400 m²).

2.2 Specific large system drain-back characteristics

Collectors:

The collectors used in the project were standard ZEN-collectors of 8,26 m² (aperture) each. These collectors are designed for long term stagnation conditions (if necessary) and are constructed with a serpentine absorber for optimal drainage and low flow conditions. The 288 collectors were mounted on a flat roof in 24 arrays (each appr. 22 x 5 m). Each collector array can be shut of from the system and bypassed.

Storage tank:

The storage tank of 95 m³ is used as drain-back tank as well. Appr. 5000 liter is used to circulate in the collector loop. The connection to the load is realized through an external heat exchanger. Therefore the storage content is directly used in the collector loop.

Collector loop:

In order to have the system operating in accordance with the drain-back principle, it is essential that all piping is fixed under a sloop. The typical angle for all piping is 10 mm/m. The piping dimensions should allow for fast draining of the water by gravity.



The flow side piping should be designed for easy airflow in the opposite directions if the system is drained.

The collector loop must be absolute air tight (closed loop). Any permeability of oxygen in the system will lead to corrosion effects and cannot be accepted in the system.

The free oxygen in the collector loop (in the storage water and the 5000 liter of air in the system) after start-up will be linked to the piping by corrosion. If the system is resting (no solar contribution) the piping and collector arrays are filled with air. The storage tank and the pumps are located 6 meter below the collector roof.

The pump capacity installed should allow for a quick filling of the systems. This will occur at least once every day. The filling procedure takes 10 minutes. The draining procedure takes 5 minutes.

Control strategy:

The control strategy consist of a relatively simple delta-T control unit. One sensor is located in the collector array at the top of a collector the other sensor is located in the storage tank at approx. 1/4 of the height. The system is activated once a temperature difference is measured between the collector array and the storage tank of 10°C. The overheating protection is fixed at a storage temperature of 85°C (if this temperature is reached, the pumps are switched of).

2.3 Lessons learned

The system functions according to the specifications. All drain-back characteristics are met. However, after appr. ½ a year some collectors were clogged by what appeared to be some

sort of sludge. More detailed evaluation indicated that this “sludge” was magnetite (Fe_3O_4), a black mineral with magnetic characteristics. It apparently was formed in the piping during the stage that the free oxygen in the system was linked to the steel in the piping. Magnetite can be removed from the system with special filters. After these filters were installed, the problem was solved. Further enquiries with experts on the subject of magnetite learned that this phenomena occurs frequently larger installations and in many instances is not recognised as such.

The experiences with drain-back on the scale of this project are, apart from the magnetite problem, very positive. It proved that this concept is very suitable for simple and maintenance free large solar heating systems.



LEGIONELLA IN HOT WATER PREPARATION

Hans van Wolferen
TNO-MEP, Apeldoorn, The Netherlands

1 Introduction

The first section of this publication contains a brief description of the Legionella bacterium, involving a characterisation of this bacterium, infection of and symptoms in human beings, and methods for detecting and controlling the bacterium. Unless stated otherwise, the text is based on a literature review performed by TNO [1] and on the Dutch Guideline ISSO 55.1 [5]. The second section is a brief overview of the Dutch regulations with respect to tap water, concentrating on hot tap water production and solar boilers.

2 Legionella

2.1 Characteristics of Legionella

Legionellae are rod-shaped, mobile bacteria that occur naturally in surface water and groundwater. Their length is 2 – 20 µm and their diameter 0.3 – 0.9 µm.

Legionella bacteria are members of the *Legionellaceae* family, with *Legionella* being the only genus. The family comprises 42 species, including *Legionella pneumophila* which is subdivided into 3 subspecies and 15 serogroups. Basically, the bacteria of these different species and serogroups show similar growth and decline behaviours.



Figure 1. *Legionella* bacteria

Factors promoting the growth of *Legionella* are:

- Water. *Legionellae* live in water; without water, they will die very quickly.
- Oxygen. *Legionellae* are aerobic bacteria; they will die very quickly in anoxic water.
- Water temperature. *Legionellae* will show growth between 20 and 50°C, with optimum growth occurring between 30 and 40°C. Above 60°C, the bacteria will die off quickly (see Fig. 2).
- Residence time. A long residence time in water at favourable temperatures may result in high concentrations of *Legionella*.
- Standstill and stagnation. *Legionella* thrives in stagnant water. Pipes or parts of an installation that have not been flushed are breeding grounds for *Legionella*.

- Acidity. *Legionella* can grow at the pH of 5.5 to 9.2, and will survive a pH of 2.2 for 5 minutes.
- Sediment and biofilm. *Legionella* requires different nutrients than other bacteria do and finds them specifically in sediment and/or biofilm. Biofilm is a slimy, algaeous deposition on parts of the installation; this deposition is composed of a random collection of bacteria, protozoa and amoebae (Fig. 3). The nutrients are procured from both the water and the inside surface of the pipe. In this biofilm, *Legionella* is more resistant to unfavourable conditions than when living free in the water.

Research has shown that biofilm does not easily attach itself to stainless steel. Copper also tends to resist it. Plastics behave in various different ways. Rubber and comparable materials offer a favourable basis for biofilm and *Legionella*. Scale and sediment can overlie and thus efface the original biofilm-resistant properties of the material.

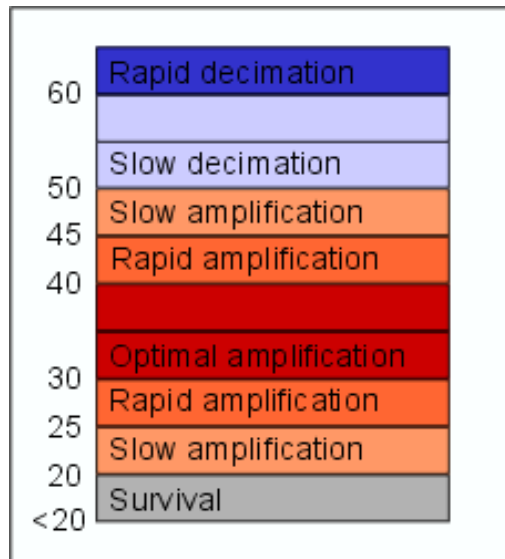

Figure 2. Growth and decline behaviours of *Legionella* are dependent on water temperature

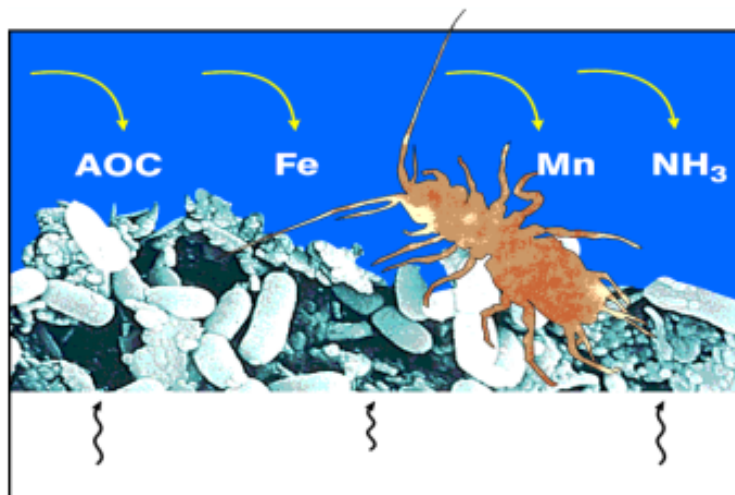

Figure 3. Impression of biofilm on inside pipe wall (with thanks to KIWA)

A special characteristic of *Legionella* is its replication within protozoa or amoebae. These single-celled organisms live in the biofilm of bacteria which they encapsulate and kill. If they encapsulate a *Legionella* bacterium, the latter will manage to behave like a parasite. The protozoa or amoebae are then eaten from the inside and filled up by a fast growing quantity of *Legionellae*, until the protozoa or amoebae burst, releasing the *Legionellae* (Fig. 4).

2.2 Infection of and symptoms in human beings

The only known infection route is the one by which people have inhaled aerosols (mists of water) contaminated with *Legionella*. The droplets are sized between 1 and 10 μm . The infection cannot be passed from person to person.

People with a weakened defence system are most at risk. Other factors that increase the chance of infection are elderliness, smoking and drinking. Also, the chance of infection is greater for males (by a factor of 2.5) than it is for females.

Infection can cause two separate diseases to develop:

- Pontiac Fever, an illness that is very similar to influenza and lasts for a couple of days. In many cases, the illness is not recognized as such.
- Legionnaires' disease, which has an incubation period of 2 to 10 days. The syndrome starts with flu-like symptoms, changing to a kind of pneumonia, followed by inflammation of various internal organs. Only 5 % of the infected persons develop this disease; however, of those that do, some 10 to 30 % die of it. Those who survive may suffer permanent damage to their lungs and other internal organs.

In the human body, *Legionellae* behave just as they do in the biofilm. If the bacteria are encapsulated by a macrophage (white corpuscle), they parasitize it, so that the infection spreads rapidly throughout the whole body, possibly affecting internal organs (see Fig. 4).

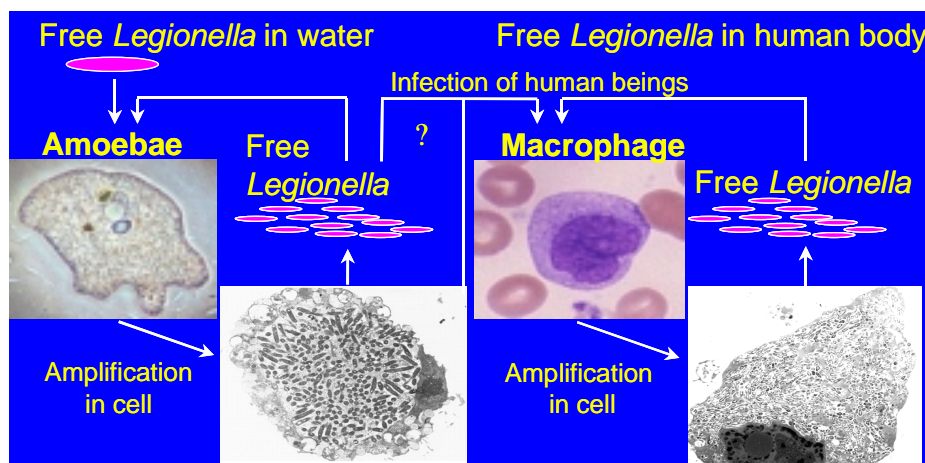

Figure 4. Replication of *Legionella* in an amoeba (at left) and in a white corpuscle / macrophage (at right).

The different types and serogroups are not all equally hazardous to human health. This is an important fact to be aware of if *Legionella* is found in an installation and, pending cleaning measures, the level of acute risk has to be assessed. However, it must also be realized that the presence of less dangerous types or serogroups indicates that the conditions are apparently favourable good for all types of *Legionella*.

2.3 Detection

In the Netherlands, there is currently only one accepted detection method, i.e., the culture as described in NEN 6265 [2]. This method measures only the presence of living *Legionellae* with a lower limit of 50 cfu/l (cfu = colony-forming units, or concentrations of one or more bacteria that form one colony on the plate). The biggest disadvantage of this method is that it takes one to two weeks before the results are known. This is particularly problematic if patients are awaiting diagnosis and if the effects of measures in infected systems need to be assessed.

Another method is the DNA method, by means of which the DNA profile of *Legionella* can be determined within one day. This method measures both dead and living *Legionellae*. It is used, for example, to determine the serogroup and such like, as well as the origin of *Legionella*.

In addition, various quick tests are currently being developed; their quality, however, is still not quite clear.

2.4 Control

In the Netherlands, the preferred methods for controlling *Legionella* in potable water systems are thermal prevention and disinfection. To prevent *Legionella* from occurring, the temperature should remain below 20 - 25°C (with only minor growth) or above 50°C (no growth possible). Above 60°C, *Legionella* will die, although a decimal reduction time of 2-3 minutes at 60°C should be taken into account.

Under some circumstances, control measures are applied, such as pipe flushing or water re-heating. Table 1 shows how long these measures should last at various common temperatures. In determining these target times, it is assumed that the concentration can have increased to 10⁵ cfu/l, so that a reduction by a factor of 3 is required.

Temperature	Flushing time in case of weekly flushing	Re-heating time
60°C	20 min.	10 min.
65°C	10 min.	1 min.
70°C	5 min.	10 s.

Table 1. Flushing time and re-heating time as functions of temperature [3].

Occasionally, higher temperatures are used. It is known, for example, that in some spas and aqua centres the pipes are cleaned every week with steam. This method is also used to disinfect systems contaminated with *Legionella* and biofilm. Here too, temperatures between 60 and 70°C are used, but at considerably longer exposure times than the ones stated in Table 1.

In addition to thermal treatment, there are various chemical and/or physical disinfection and prevention methods available. An inventory of these methods was made in a recent report [4]. Below, a survey of these methods is given, including the substances released in these processes, as applicable to potable water.

These methods must also be supplemented with control measures, both to guarantee proper operation of the equipment, and to see to it that the entire installation including all outlets is covered. Here too, dead pipes or pipes that have not been flushed may continue to be breeding grounds for *Legionella*.

Type of treatment	Description	Active substances
Thermal treatment	See previous paragraph.	None
Pasteurization	Special execution of thermal treatment.	None
Doses of sodium hypochloride	<ol style="list-style-type: none"> 1. Short-term application (several hours) of high concentration 2. Continuous low concentration in the entire system. 	NaOCl <ol style="list-style-type: none"> 1. Minimally 20 mg/l 2. Up to 5 mg/l (max. 8 mg/l) This forms: HOCl (pH<6.5) OCl ⁻ (pH>8.5) High concentrations may cause significant corrosion of copper pipes.
Doses of chloro-dioxide	<ol style="list-style-type: none"> 1. Short-term application (several hours) of high concentration 2. Continuous low concentration in the entire system. 	ClO ₂ <ol style="list-style-type: none"> 1. Up to 1.5 mg/l 2. Up to 0.2 mg/l Residue: chloride. The above doses will have only a minor effect on pipe material.
Doses of chloro-amine	Continuous low concentration in the entire system is the most worthwhile application.	ClNH ₂ to 2 mg/l. In this process, ammonia may be released, forming strong complexes with copper, thus possibly preventing the formation of a protective covering layer.
Doses of hydrogen peroxide	Solely for short, periodic treatment, applied for maximally 24 h. It kills bacteria in the entire system.	H ₂ O ₂ concentration of 200-500 mg/l. At low concentrations, the effect on pipe material is minor.
Anodic oxidation / electrolysis	By way of electrolysis, substances present in the water are converted into oxygen radicals, atomic oxygen, hydroxyl radicals, elementary chlorine and HOCl. This kills bacteria in the entire system.	Concentrations ? Organic byproducts < 5 µg/l
Copper/silver ionization	Formation of copper and silver ions by way of ionization.	Copper ions 100 - 400 µg/l. Silver ions 10 - 40 µg/l.
Membrane filtration	Microfiltration and ultrafiltration to keep out passing bacteria.	None
UV disinfection	Local UV radiation kills passing bacteria.	None
Electrical pulses	This affects the cell wall of the bacterium.	Presumably none.

Table 2. Survey of alternative disinfection methods to prevent and control *Legionella*.

Points of attention in selecting one or more methods are:

- Toxicity for humans;
- Possible effects on the installation;
- Method (continuous / regular / occasional);
- Activity (local / entire installation);
- Control measures;
- Cost.

At this stage, it should be emphasized that there is an essential difference between methods with a local effect and those that affect the entire installation.

Local methods kill *Legionella* at one spot. This leaves the possibility of *Legionella* and biofilm growing on both sides of this very spot. Examples of such local methods are pasteurization, membrane filtration, UV and electrical pulses.

So-called global methods affect the entire installation from the dosing point on. Examples of such methods are the majority of thermal and chemical methods.

3 Dutch Regulations For Tap Water

3.1 Introduction

In order to prevent outbreaks of infection by the *Legionella* bacteria, the Dutch government has issued a number of rules with respect to collective tap water systems. These rules have been put down in the "Temporary Directive for *Legionella* Prevention in Tap Water" issued by the Ministry of Housing, Spatial Planning and the Environment (VROM) [3], further to be referred to as the "Temporary Directive". This directive states that it is compulsory for public or collective systems to have a risk analysis for *Legionella* prevention performed and, if necessary, to draft a control plan. Tap water comprises the following 'types' of water: drinking water, hot tap water and water for domestic use.

As a result of the Temporary Directive, ISSO publication 55.1 "Guide for *Legionella* Prevention in Tap Water" was developed [5], further to be referred to as the "Guide". This Guide contains tools and regulations for conducting a risk analysis and drafting a control plan that can be applied to all tap water systems. The guide follows ISSO publication 55 'Tap Water Systems in Domestic and Utility Buildings'. A large number of measures have already been described in the Vewin² guidelines [6], but some points have been stepped up.

The rules for individual systems are set only by NEN 1006, a standard that is currently being adapted. For more complex systems, such as solar boilers, the draft text refers to the risk analysis as described in the Temporary Directive.

In all cases, alternative approaches are permitted, provided they produce equal results (no risk).

Directives for *Legionella* prevention are also available abroad. Two examples are the directives issued by ASHRAE [7] and CIBSE [8].

The Temporary Directive and the ISSO Guide are briefly summarized below.

3.2 The Temporary Directive

The Temporary Directive was put into force on 15 October 2000, and will be valid for maximally two years. The Directive will then be converted into long-term legislation.

The Temporary Directive contains, among other things, the following stipulations (for the sake of readability, a free interpretation of the text is given here; for the verbatim text, the reader is referred to the actual directive):

- Tap water should not contain any demonstrable quantity of *Legionella* bacteria at the taps. The current methods use a detection limit of 50 colony-forming units (cfu) per litre. This stipulation applies solely if the water can be used in such a way that aerosols are formed and there is a situation in which people can inhale these aerosols, as is the case with showers.
- The owner of a collective water supply system or a waterworks is responsible for ensuring that the tap water supplied by him meets the requirements set.
- In order to assess whether the requirements are met, the owner must have a risk analysis performed every three years. In case of changes to the plant, the risk analysis must be performed again within three months after the change.

² Vewin = Dutch Water Association

- If the risk analysis shows the necessity of control measures, the owner should have a control plan drawn up.
- The owner executes control measures in accordance with the control plan. Measures and checks should be recorded in a logbook.
- The risk analysis and the control plan must be recorded in writing and remain available, together with the logbook, for the supervisor's perusal.

Directives for performing a risk analysis and drafting a control plan are given in two appendices. The explanation also contains the recommended sampling frequency.

The basis for the risk analysis is risk qualification; for this, the symbols of Table 3 are used.

Symbol	Meaning
0	Neutral < 50 cfu/l (absolute)
+	Reduction with a factor of 10
++	Reduction with a factor of 100
+++	Reduction with a factor of 1000
-	< 10 ³ cfu/l
--	< 10 ⁴ cfu/l
---	< 10 ⁵ cfu/l

Table 3. Symbols for risk qualification.

The combination of temperature and duration determines the risk qualification for parts of the installation, as stated in Table 4.

Risk factors						
Temperature (°C)	Duration of temperature in component	Risk qualification (+ dying off; - growth)	Duration of temperature and component	Risk qualification (+ dying off; - growth)	Duration of temperature in component	Risk qualification (+ dying off; - growth)
< 20	Unlimited	0				
20 – 25	Unlimited	0				
25 – 45	< 2 days	0	> 2 days < 1 week	-	> 1 week	---
45 – 50	Unlimited	--				
50 – 55	Unlimited	0				
55 – 60	> 1 hour	+	> 2 hours	++	> 3 hours	+++
60 - 65	> 3 min	+	> 5 min	++	> 10 min	+++
65 - 70	> 20 sec	+	> 40 sec	++	> 1 min	+++

Table 4. Risk qualification as a function of temperature and duration. For pipe volumes < 1 liter, the risk qualification is neutral (0).

3.3 Practice Guideline ISSO 55.1

The objective of the ISSO guide is to achieve demonstrably *Legionella*-safe tap water systems that meet the standards set forth in the Temporary Directive.

3.3.1 Method

In order to conduct a risk analysis, one of the following methods must be chosen:

- Limited risk analysis.
A limited risk analysis solely considers whether aerosols can be formed at the taps and whether people are exposed to this in such a way that a hazardous situation may arise if the water contains high concentrations of *Legionella*. Therefore, this method does not reveal whether or not the tap water contains *Legionella*. The only question it answers is

whether people will be at risk by being exposed to "relevant quantities of inhalable aerosols". This method is particularly suitable for systems with (practically) no taps where relevant quantities of inhalable aerosols can be formed.

- Extensive risk analysis.
An extensive analysis covers the entire system – from raw material (intake of tap water) to the taps – in order to determine whether situations can occur in which *Legionella* can attach itself and develop to detectable concentrations. The risk qualification is specifically based on the combination of duration and temperature of system parts. Dutch potable water is not chlorinated and contains only few bacteria (probably 1 cfu *Legionella* / 2500 l, but possibly occasionally higher).

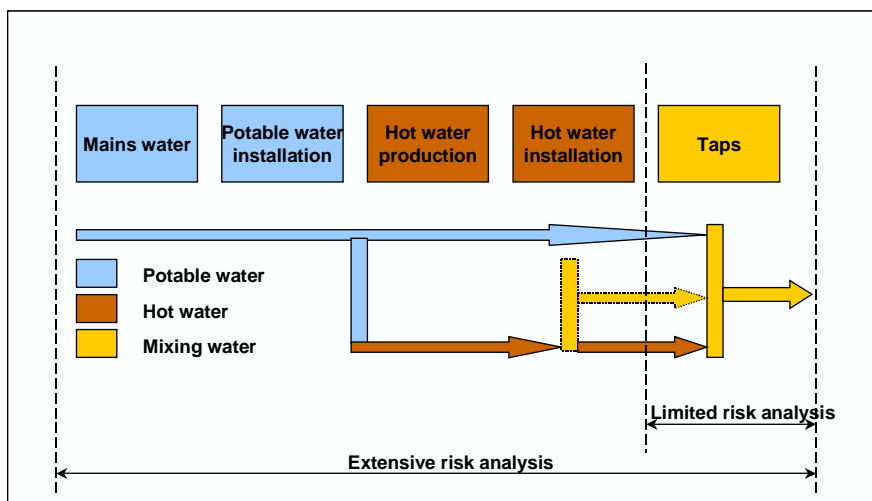

Figure 5. Main functions of the installation to which the risk analysis is applied.

3.3.2 Limited risk analysis

The objective of this analysis is to assess the extent to which relevant quantities of inhalable aerosols can be formed when taps are used that are part of a water system or connected to it.

For the risk analysis, the following data are collected per tap:

- number of taps (on drawing or floorplan of building);
- location of taps (description of the room);
- type of tap (e.g., sink, washbasin, bath, shower, toilet, fire-hose);
- water connection: domestic water, potable water and/or hot water;
- relevant aerosol formation (the Guide gives directives per type of tap);
- preventive measures (only required in case of possible relevant aerosol formation).

3.3.3 Extensive risk analysis

For the risk analysis, the tap water installation is divided into five main functions (Fig. 5). The analysis shows whether there is a chance of growth of possibly present *Legionella* bacteria in each of these main functions. The installation is considered safe only if this chance is nil for all functions.

Two tools have been developed for simple risk determination in regularly recurring situations:

- checklists for the five main functions (example in Appendix 1);
- a survey of frequently occurring components with a risk rating for their various applications (example in Appendix 2).

For the risk analysis, data are collected with respect to:

- the installation;

- the ambient temperatures of the installation;
- the operation and the use of the installation.

The risk analysis consists of the following steps:

- for every main function, the tap water system is subdivided into separate components;
- risk analysis per component;
- risk analysis per main function and for the entire system.

In the majority of cases, these data make it possible to reduce the entire installation to a number of frequently used (components of) tap water systems whose risk level has already been ascertained. In these cases, it is not necessary to examine the installation; the risk analysis can be copied from the Guide.

The risk analysis for the entire system is based on the risk analysis per main function. The general rule that applies here is: *Each main function must be completely risk-free. A high risk level in one function can therefore in no way be compensated for by a lower risk level in another.*

3.3.4 Action to be taken following risk analysis

The risk analysis may reveal a number of problem areas that may facilitate undesired *Legionella* growth. These problems can be solved in two ways, i.e.:

- by making changes in the system;
- by applying control measures.

In addition to this, of course, system changes may be necessary to make control measures possible.

In a number of cases, a problem can be solved via both approaches. In these cases, the costs, among other things, will determine which of the two approaches is chosen. In general, changes in the system are preferred as they provide a more structural solution. For temporary situations, however, control measures may be preferred.

The remaining risk should be dealt with via control measures. The following types of measures are used for this:

- a check-up on the proper functioning of the system;
- measures to prevent *Legionella* growth;
- changes in the control plan due to changed system use;
- corrective measures, if *Legionella* is found in the system.

The checklists and the component assessment will immediately show the most desired or required control measures. This will produce a list of possible measures.

3.3.5 The control plan

The control plan must, first of all, state clearly to which system it applies (name, address and nature of company or institute), the person responsible for taking action, and the person authorized to do so.

It is drafted on the basis of the data produced by the risk analysis. Among these data will be a list of possible control measures. The control plan arranges the control measures per system component and frequency (for example, weekly, monthly, yearly).

The control plan must further identify the person(s) to whom tasks and authority have been assigned per (group of) control measure(s).

It must also state which measures will be taken if and when the number of 50 cfu/l *Legionella* bacteria is exceeded. In all cases, the supervisor will be informed about such an excess.

3.3.6 Management

On the basis of the control plan, a logbook is kept in which is recorded who took which measures when. For this, forms such as the one in Fig. 6 can be used. The Guide contains an appendix with a detailed description of how to set up a control plan and logbook.

Sort	<i>Temperature measurement</i>				
Frequency	<i>Once a week</i>				
Person	<i>Van Wolferen</i>				
Control measures				Execution	
				Date: <i>28-03-2001</i>	
Description	Code / location	Instruction / req. value	Remarks	Initials	Result / remarks
<i>Outlet appliance1</i>	<i>TF</i>	<i>> 65°C</i>	-	<i>vW</i>	<i>67 °C</i>
<i>Return hot water</i>	<i>TR</i>	<i>> 60 °C</i>	-	<i>vW</i>	<i>63 °C</i>
<i>Potable water</i>	<i>T1-T10</i>	<i><=25 °C</i>	-	<i>vW</i>	<i>Tmax: 17 °C</i> <i>Tend: 12 °C</i>

Figure 6. Example of form for logbook.

4 Example of Risk Analysis for Solar Boiler

Fig. 7 shows the diagram of a type of solar boiler that is frequently used in the Netherlands. Re-heating is done by way of an instantaneous or storage water heater.

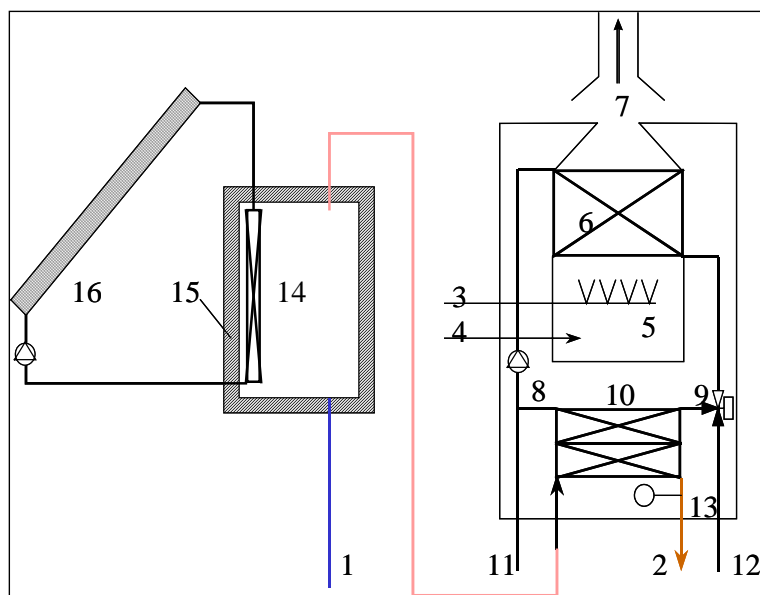

Figure 7. Solar boiler with instantaneous after-heater

In the risk analysis, the risk is first determined for each separate appliance; next, the risk is determined for the entire hot tap water production in conformity with the rules for "boilers in series without charging system".

The risk of the solar boiler is determined by the temperature – duration which depend mainly on the combination of solar heat, tap water use, vessel volume, and vessel losses. On the basis of general data, two extreme operating situations can be imagined:

- Sunny/summer. There is so much sunshine in proportion to the tap water use that temperatures above 60°C are reached in the entire vessel almost daily.
- Cloudy/winter. In case of little solar heat, a temperature between 20 and 50°C will be reached in large parts of the vessel. If the temperature, specifically at the bottom, remains above 25°C for a long period of time, a situation arises that is essentially favourable for the settlement and growth of *Legionella*.

Therefore, the worst situation is most likely to occur in winter, when a temperature favourable for *Legionella* may occur for a longer period of time. In the summer, on the other hand, temperatures high enough to kill all micro-organisms in the entire water storage will occur regularly.

On the basis of the Temporary Directive, such an appliance could be assessed with – to ---, if no further data are known.

In instantaneous after-heaters, set at 60°C, the residence time is too short for the bacteria to be killed so that this does not offer compensation.

In applying storage heaters as after-heaters, a maximum extermination (+++) can be reached at a setting above 60°C after a residence time of 10 min. However, features are then required that guarantee that these conditions are met under all circumstances.

In order to achieve safe solar boilers, various solutions are possible.

In the thermal approach, the vessel is provided with a heating element at the bottom that can heat up the entire vessel to 60°C if the temperature has reached undesired values for too long.

Another approach, which has been proposed by manufacturers, focuses on a clean construction of the vessel so that micro-organisms can find no breeding ground. In such a design, the vessel is made of stainless steel, with smooth links and joints, no rubber rings, etc., and an optimal flow through the vessel. This appliance would have to be drained each year to remove any sediment from the bottom. It is not clear whether or not descaling would be required; this has yet to be investigated.

In order to assess the adequacy of this alternative approach, tests in which artificial contamination with *Legionella* and biofilm will be examined, are currently being considered.

5 Literature

1. *Legionella* in warmtapwatersystemen, deel 1 – warmtapwatersystemen (R99/151)
[*Legionella* in Hot Tap Water Systems, Part 1 – Hot Tap Water Systems (R99/151)]
J. van Wolferen, Ph. van Dalen, B.J. Hartog
TNO, Apeldoorn, The Netherlands, October 1999
2. NEN 6265. Onderzoek naar de aanwezigheid en het aantal kolonievormende eenheden van *Legionella*-bacteriën
[NEN 6265. Research into the Presence and the Number of Colony-Forming Units of *Legionella* Bacteria]
NEN, Delft, The Netherlands

3. Tijdelijke regeling *Legionella* preventie in leidingwater
[Temporary Directive for *Legionella* Prevention in Tap Water]
Ministry of Housing, Spatial Planning and the Environment (VROM), 13 October 2000
4. Alternatieve technieken voor *Legionella* preventie: kenmerken en beoordeling
[Alternative Techniques for *Legionella* Prevention: Characteristics and Assessment]
Paul Buijs c.s.
Kiwa, Nieuwegein, The Netherlands, November 2000
5. ISSO 55.1 - Handleiding *Legionella* preventie in leidingwater
[ISSO 55.1 – Guide for *Legionella* Prevention in Tap Water]
ISSO, Rotterdam, The Netherlands, 2000
6. Vewin werkbladen
[Vewin (Dutch Water Association) Guidelines]
Vewin, Rijswijk, The Netherlands, 2000
7. ASHRAE Guideline 12-2000 – Minimizing the Risk of Legionellosis Associated with Building Water Systems
ASHRAE, Atlanta, GA, USA, 2000
8. CIBSE TM13:2000 - Minimising the Risk of Legionnaires' Disease
CIBSE, London, UK, October 2000

The author has been involved in drafting the risk analysis model for the Temporary Directive and is an observer for ISSO publication 55.1.

Appendix 1. Example of ISSO 55.1 Checklist

Hot Tap Water Production Checklist (appliances)

If hot tap water is prepared at several separate locations, the following steps should be taken per set-up location.

Fig. B5.1 gives a number of set-up possibilities.

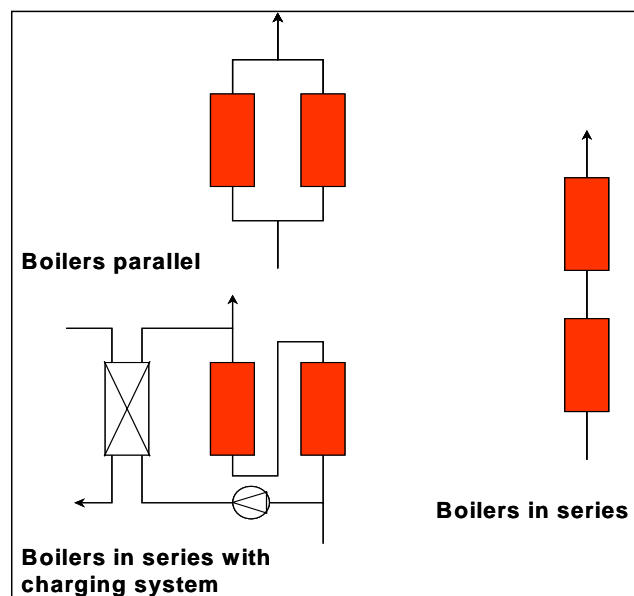

Figure B5.1. Various set-up possibilities.

Data of hot tap water production (1)		General data
Concerns	Answer	Assessment & action
Set-up location		n.a.
Number of appliances		n.a..
Set-up of appliances (in case of more appliances)	<ul style="list-style-type: none"> – N.a. – Parallel – Series without charging system at uniform temperature – Series without charging system at various temperatures – Series with charging system – Otherwise, i.e.: 	See Appendix 6 (here Appendix 2)

The following data should be given for each appliance.

Data of hot tap water production (2)		Data per appliance		
Appliance serial number, brand, type, year of construction	Type of appliance (see Appendix 6)	Assessment & action		
1. ...		n.v.t.		
Data of temperatures	Value			
Temperature setting: continuous or periodical				
Temperature setting(s) (°C) (Vewin WB 4.4A, art 4.5 requires min. 60°C)				
Temperature measured at outlet (°C) (at maximal flow for instantaneous heaters)				
Temperature measured in <i>return pipe</i> in case of circulation system. (Vewin WB 4.4A, art 4.6. requires min. 60°C)				
Data readers	na	ok	Not ok	
Readable thermometer at appliance outlet				If "not ok", install feature.
Readable thermometer on return pipe of appliance in case of circulation system.				If "not ok" install feature.
Conclusion per appliance				
Risk assessment, if action is taken				See Appendix 6 (here Appendix 2)

If risk assessment and control measures have been performed for all appliances, the risk assessment can be made for the entire hot water production.

Data for hot tap water production	Risk assessment
Risk assessment, if action is taken	

Appendix 2. Example of Component Description and Assessment from ISSO 55.1

Component

Storage heaters:

- Directly heated storage vessels (gas or oil boiler).
- Electric boiler
- Indirectly heated storage vessel
- Storage vessel without heating features (part of charging system)

Preconditions

See Checklist Hot Tap Water Production.

Assessment

Temperature setting and tap use	Assessment
25 to 45°C. Daily thermal disinfection	0
25 to 45°C. Weekly thermal disinfection (see guidelines below)	- ¹
25 to 45°C. No thermal disinfection.	---
45 to 50°C.	--
> 50°C.	0 ²

Note:

1. In case of weekly preventive thermal disinfection, *Legionella* may occasionally occur in concentrations above the detection limit. If this happens, there is no reason to expect high concentrations.
2. A temperature $\geq 60^\circ\text{C}$ is recommended.

Guidelines for weekly thermal disinfection of storage vessels.

Temperature	Required duration
60°C	20 minutes
65°C	10 minutes
70°C	5 minutes

Note:

The duration required is counted from the moment that the entire storage has reached the desired temperature. If thermal stratification occurs in the storage, the temperature at the bottom of the vessel should be used as reference temperature for the duration.

Assessment	0	+	++	+++
Temperature setting and residence time				
55 to 60°C. Residence time:	≤ 1 hour	> 1 hour	> 2 hours	> 3 hours
60 to 65°C.	≤ 3 min.	> 3 min.	> 5 min.	> 10 min.
65 to 70°C.	≤ 20 sec.	> 20 sec.	> 40 sec.	> 1 min.

Notes:

- If the purpose of a storage vessel is also to neutralize any *Legionella* growth in preceding vessels by after-heating (thermal disinfection), it should be guaranteed that the water remains in the vessel for minimally the required time at the given temperature. Under no condition may a shorter residence time and/or a lower temperature occur.
- In all storage vessels, thermal stratification may occur, with the temperature at the bottom lower than the temperature at the outlet and/or near the thermostat. This effect is largest in indirectly heated boilers and electroboilers, in which the heat exchanger or the heating element is placed at a high point, and thus relatively far away from the bottom. This effect may also occur in so-called “wet-foot” boilers. If this effect occurs, there will be little or no

Legionella extermination in the lower layers of the vessel. If no data are known, a temperature difference of 5 °C between temperature reader and vessel bottom should be assumed.

- Insufficient charging of boilers may also result in there being a zone with permanently lower water temperatures.
- During peak hours, a temporary drop in temperature may occur. In most cases, this is permissible, as long as the water reaches the set temperature for one or more hours daily. However, it is not permitted if a vessel is used as after-heater for thermal disinfection (see first note).

System changes

- Appliances that cannot supply the required temperatures should either be adapted or replaced.

Control measures

- Weekly measurement and recording of temperatures at outlet and return (manually or by way of BEMS).
- Weekly thermal disinfection, if applicable (manually or by way of BEMS).
- Annual control of proper working of temperature setting.
- Annual calibration of temperature readers.
- Annual sediment removal by draining at the bottom [2].

Component

Hot water production: instantaneous storage water heaters with minimum content.

Preconditions

See Hot Water Tap Production Checklist.

Assessment

Temperature setting and tap use	Assessment
25 to 50°C.	-
> 50°C	0

Assessment	0	+	++	+++
Temperature setting and residence time				
55 to 60°C. Residence time:	<= 1 hour	> 1 hour	> 2 hours	> 3 hours
60 to 65°C.	<= 3 min.	> 3 min.	> 5 min.	> 10 min.
65 tot 70°C.	<= 20 sec.	> 20 sec.	> 40 sec.	> 1 min.

Notes:

- Considering the short residence time of water in instantaneous storage water heaters, they should not be used as after-heaters for thermal disinfection at temperatures below 65°C.
- For normal use, a temperature setting below 60°C is not advisable.

System adaptation

- Appliances that cannot supply the required temperatures should be adapted or replaced.

Control measures

- Weekly measurement and recording of temperatures at outlet and return, if appliance is part of circulation system (manually or by way of BEMS).
- Annual control of proper operation of temperature setting.
- Annual calibration of temperature readers, if appliance is part of circulation system.

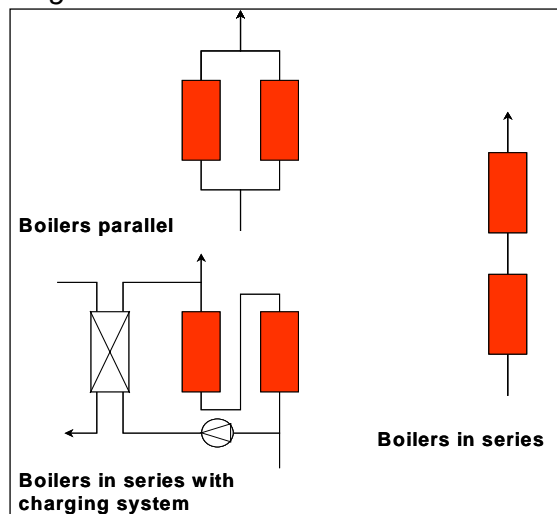
*Component***Hot tap water production: assessment of set-up with various hot tap water appliances.***Diagram**Preconditions*

See Hot Tap Water Production Checklist.

Assessment

Type of set-up	Assessment
Parallel	Each appliance should have a neutral (0) or positive (+) risk rating.
Series with charging system	Each appliance should have a neutral (0) or positive (+) risk rating.
Series without charging system	A possibly negative risk rating of the first appliance can be compensated by an equally or more positive risk rating of the second appliance. This is specifically important if the first appliance is a low-temperature boiler (e.g. heated by a heat pump or solar boiler).

Example of risk rating for two appliances in series, without charging system.

Rating of first appliance	Rating of second appliance	Total rating	Total Rating
0	0	0	Neutral
-	0	-	Insufficient
-	+	0	Neutral
--	+	-	Insufficient
--	++	0	Neutral
---	++	-	Insufficient
---	+++	0	Neutral

Note:

The positive assessment of the second appliance assumes sufficient residence time of the water at the set temperature. The system should be designed in such a way that this requirement is met at all times.

If due to an abnormally large demand, the water from the first boiler flows to the taps without being sufficiently heated in the second boiler, this requirement is not met.

Control measures

See the measures stated for the individual appliances.

LEGIONELLA AND SOLAR DOMESTIC HOT WATER SYSTEMS

Mr. Daniël J. Naron
TNO Building and Construction Research
P.O. Box 49, 2600 AA Delft
The Netherlands
Tel: +31 15 269 52 49
Fax: +31 15 269 52 99
E-mail: D.Naron@bouw.tno.nl

Abstract

In this paper a method has been described in order to determine the (possible) risks of *Legionella* bacteria in solar domestic hot water (sdhw) systems. In this method the temperatures in the solar storage have been considered. Using this method on a typical Dutch sdhw system, it shows that possible *Legionella* risk (if the temperatures concerned) will be mainly in a winter period. It is recommended to do further research on biofilm connected to the surface of the solar store.

1 Introduction

An exploratory study has been carried out paid by NOVEM³ on *Legionella* and sdhw systems. The purpose of this study was to develop a method to determine the (possible) risks of *Legionella* bacteria in these solar systems. This method has been tested on a typical Dutch sdhw system.

The *Legionella* bacteria are highly sensible for temperatures. At this moment, the temperature present in the solar store is the only hard criterion that allows excluding a *Legionella* risk. Therefore this method is focussed on temperature aspects within the solar store of sdhw systems.

2 Method development

The questions to be answered by this method are the following:

- What temperatures occur in the solar store at different positions in this store?
- How long does a certain temperature last?
- How often (a part of) the solar store will be in a dangerous situation ($\theta < 50^{\circ}\text{C}$ = *Legionella* growth)?
- In what way this situation of *Legionella* growth will be turned into a situation of *Legionella* diminishing / eradication ($\theta > 60^{\circ}\text{C}$) and for how long?

With a computer model the occurring temperatures in the solar store have been calculated for a whole (Dutch) reference year. For the sdhw system dimensions, see Figure 1 and Table 1. A typical Dutch draw off pattern has been used for the calculations.

In order to determine the temperature distribution along the height of the store, this store has been divided into segments. It is assumed that each segment has a uniform temperature; the store surface temperature⁴ is equal to the temperature of the surrounding water.

³ Dutch Organisation for Energy and Environment

⁴ *Legionella* bacteria are likely to be dependent on the presence of a biofilm. This biofilm is connected to the inner surface of a store.

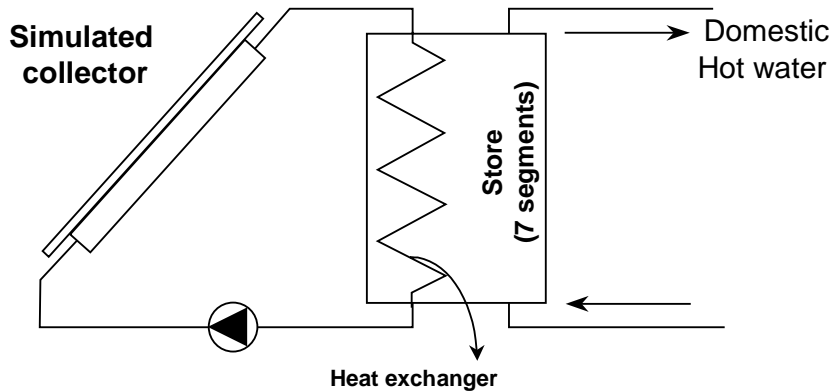

Figure 1 Schematic view of the SDHW system concerned

Table 1 SDHW system data

		SDHW system
Collector Area		3.0 m ²
Tilt angle, Azimuth angle		45°, South
Collector curve		$\eta = 0.8 - 3.0 T^* - 0.01GT^{-2}$
Store Volume		104 litre
Store Dimensions		$h \times D = 0.75 \times \varnothing 0.42$ [m]
Store Insulation		$k = 1.2 \text{ Wm}^{-2}\text{K}^{-1}$ $U_A = 1.52 \text{ WK}^{-1}$
Met	G: Solar Irradiation	[W m ⁻²]
	T*: $(T_{\text{absorber}} - T_{\text{ambient}}) / G$	[K m ² W ⁻¹]
	U_A: k-value * exchanging surface	[W K ⁻¹]

3 Energy supply and energy draw off

The quantity to be determined is the inner store surface temperature. Two aspects will influence this temperature:

1. Energy supply: Solar irradiation on the collector
2. Energy draw off: Hot water draw off
Heat losses

For the draw off, a typical daily domestic load has been used: 150 litres/day, spread out over the day. The mains water temperature is assumed to be 10°C.

Period of absence

Another aspect to be studied is the temperature behaviour of the solar store after period without any draw off (a holiday period). By shifting the start of this period throughout the year this will result into a temperature profile describing the seasonal influence of a period of absence.

4 Results

In order to interpret the temperature profile of the solar store, this profile will be presented as follows:

From each segment from the solar store it will be established:

- The frequency and duration that a temperature will be continuously into one specific temperature region (*Legionella* growth / diminishing).
- The temperature distribution after each period of absence.
-

Legionella growth and diminishing

To be able to describe the *Legionella* growth and diminishing behaviour, two zones will be defined:

- (I) $\theta < 50^{\circ}\text{C}$ (*Legionellae* survive / grow)
- (II) $\theta > 50^{\circ}\text{C}$ (*Legionellae* diminish)

Zone I has been divided into 3 subzone's (a, b and c):

- (Ia) $\theta < 25^{\circ}\text{C}$; $45^{\circ}\text{C} < \theta < 50^{\circ}\text{C}$ (slow *Legionella* growth)
- (Ib) $25^{\circ}\text{C} < \theta < 30^{\circ}\text{C}$; $40^{\circ}\text{C} < \theta < 45^{\circ}\text{C}$ (quick *Legionella* growth)
- (Ic) $30^{\circ}\text{C} < \theta < 40^{\circ}\text{C}$ (optimal *Legionella* growth)

In general an optimal growth temperature ($30^{\circ}\text{C} < \theta < 40^{\circ}\text{C}$) means that a small colony of *Legionellae* (< 50 units⁵ per litre) can grow within ± 5 days into a high *Legionellae* concentration ($> 10^5$ units per litre). This high concentration can be dangerous in a large hot water store in case the auxiliary (after) heating is not sufficient for eradication.

Also the zone II *Legionella* diminishing can be divided into 3 sub zones:

- (IIa) $50^{\circ}\text{C} < \theta < 55^{\circ}\text{C}$ (slow diminishing; hours)
- (IIb) $55^{\circ}\text{C} < \theta < 60^{\circ}\text{C}$ (moderate diminishing; quarters)
- (IIc) $\theta > 60^{\circ}\text{C}$ (quick diminishing; minutes)

Figure 2 presents the so-called 'frequency distribution'. In this graph a distribution has been presented of the duration and its frequency that the store (segment) will be continuously lower than 50°C . Figure 2 shows that it is very often that the solar store is no longer than 4 days under 50°C before thermal disinfection (*Legionellae* eradication).

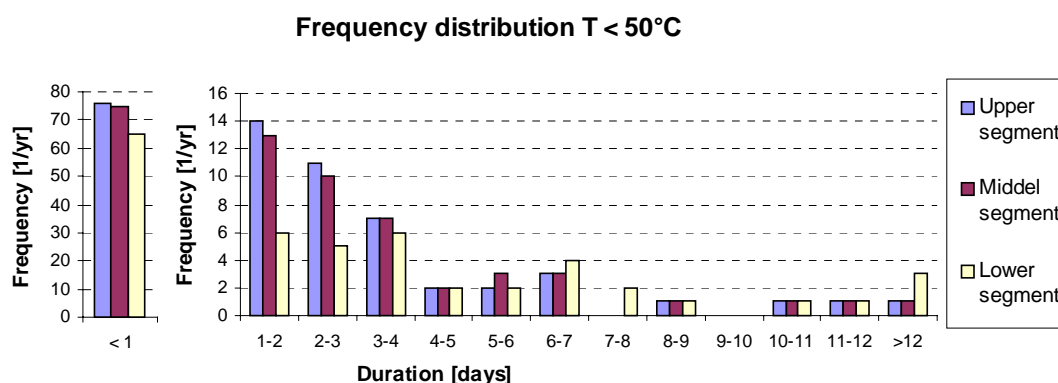

Figure 2 Frequency distribution for the several store segments
'How often the segment temperature will be lower than 50°C ?'

From the duration more than 4 days (continuously) lower than 50°C , the segment temperature will be analysed more in detail; this could be the risk zone for *Legionella* growth.

In Figure 3a a so-called 'temperature distribution' is presented of the upper store segment. Every time this segment is more than 4 days continuously under 50°C , a subdivision into sub zones has been made. The temperatures of *Legionella* growth are connected to *Legionella* diminishing. Every period of growth is followed by a period of thermal disinfection. Also this period is divided into sub zones. In Figure 3b this (second) temperature distribution shows the period of thermal disinfection after a period of (possible) *Legionella* growth.

⁵ A colony dimension < 50 units per litre cannot be detected by the present detection methods.

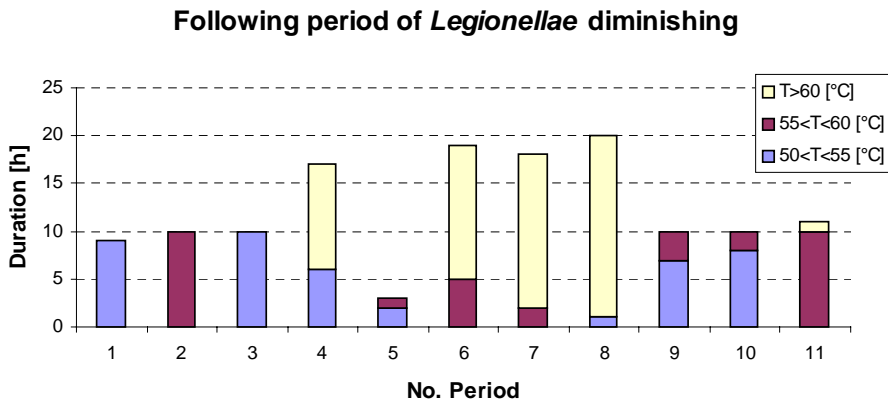
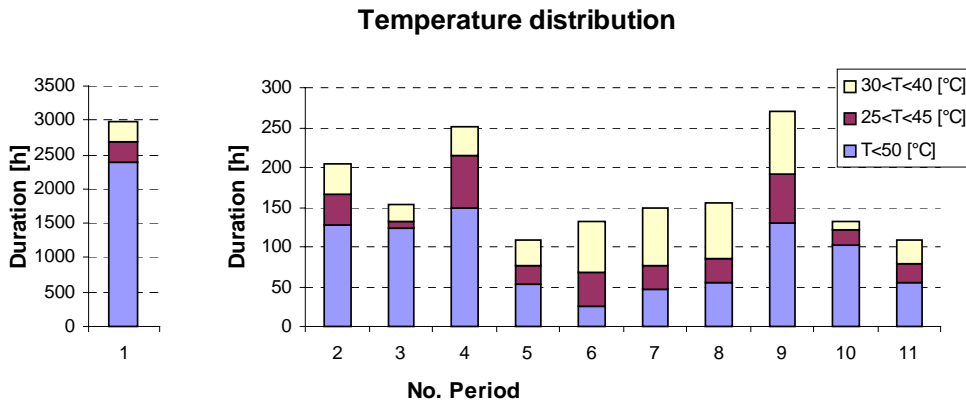

Figure 3 The growth (a) and following periods of diminishing (b), every time that the upper store segment temperature is longer than 4 days continuously under 50°C.

Period(s) of Absence

Figure 4 shows the temperature profile of the solar store after a period of absence (one week without any draw off). The temperature after this period is rubricated per segment; these are depicted as the coloured bars in Figure 4. Also the maximum temperatures during this period of absence have been calculated ($T_{max,bottom}$ and $T_{max,top}$).

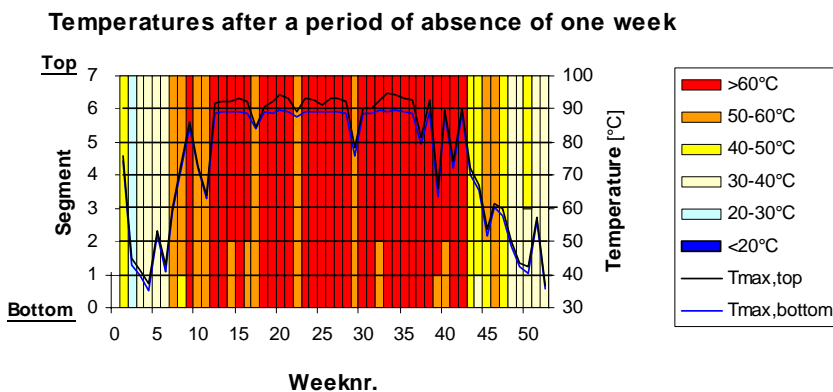

Figure 4 Temperature profile of the solar store after a period of absence (one week without draw off)

Observations

- The fact that *Legionella* growth cannot be excluded between the temperatures 30-50°C (in case of sufficient culture medium), in winter (between week 45 and week 7) after a period of absence of one week or more there is a possible risk for *Legionella* growth.

- In summer (between week 8 and week 46) there will be a total thermal disinfection / eradication of *Legionella* in the entire solar store.
- After a period of absence the solar store shows hardly any stratification. The store will be uniform in temperature ($\Delta T < 10K$).

5 Conclusions

In this paper a method has been described in order to determine the (possible) risks of *Legionella* bacteria in solar domestic hot water systems. In this method the temperatures in the solar storage have been considered.

The following can be concluded:

- The method being developed is well able to analyse SDHW systems on a possible *Legionella* risk.
- The assumption in the simulation model used that each store segment has a uniform temperature has been established/proved to be right by experiments⁶.

Legionellae growth and diminishing

- The fact that *Legionella* growth cannot be excluded between the temperatures 30-50°C (in case of sufficient culture medium), in winter there is a possible risk for *Legionella* growth.
- Regularly during the year there will be a total thermal disinfection / eradication of *Legionellae* in the entire solar store. After such a period of thermal disinfection, the SDHW system will be '*Legionella safe*'.
- The possible *Legionella* risk will be mainly in the upper segment; in the lower segments of the store the duration of risky temperature levels is considerably shorter.

6 Recommendations

From this exploratory study the following recommendations can be done:

- Apply the method described on a representative number of sdhw systems for several reference climates.

For *Legionella* growth a culture medium is necessary. Concerning sdhw systems this medium is likely to be a biofilm connected to the inner surface of a store.

- It is recommended to do more research on biofilm in the solar store.

Given the possibility of biofilm and given the temperature risk on *Legionella* growth in solar stores:

- It is recommended to map the control and engineering possibilities to guarantee a *Legionella safe* sdhw system.
- It is recommended to develop a method for solar domestic hot water systems in order to be able to issue in (near) future a certificate '*Legionella safe*'.

7 References

- [1] Staatscourant nr. 243 (1999), Tijdelijke regeling *Legionella*-preventie in leidingwater, VROM, Den Haag, [pag. 21](#)
- [2] ISSO-publicatie 55.1: *Legionella* preventie in leidingwater, ISSO, Rotterdam, 2000.
- [3] D.J. Naron, *Legionella* en zonneboilers, TNO Building and Construction Research, Delft, The Netherlands, September 2000.

⁶ These experiments have not been described in this paper

ROOF INTEGRATION OF LARGE COLLECTOR AREAS - EXPERIENCES FROM NORWAY

M. Meir, J. Rekstad, B. Sandnes
University of Oslo, P.O. Box 1048 Blindern, 0316 Oslo, Norway
Tel: +47 22 85 64 69, Fax: +47 22 85 64 22
E-mail: mmeir@fys.uio.no

Abstract

The demand of larger collector areas in solar combisystems make roof integration a natural issue. Certain physical aspects related to the roof construction and the consequence of collector integration are pointed out. The extent to which "collector roofs" are pre-fabricated will influence the on-roof mounting process, with respect to the costs and the branch carrying out the installation. Large collector fields cause a significant impact on the exterior building design. Architectural and aesthetic aspects are discussed.

1. Introduction

The growing interest for combined solar systems, in which solar energy is used for space heating as well as for heating of domestic hot water (DHW), represents new challenges for the solar industry. The collector area needed in these systems is substantially larger than in the conventional SDHW systems. In this article the expression "large collector area" is used in terms of "what is required for solar combisystems" (not: "large scale").

A collector area in the range of 10 - 30 m² on a single-family house becomes a dominating architectural element. The integration of solar components in a building, and the substitution of conventional building elements with elements belonging to the solar system are important aspects which will be discussed. Hence the solar industry expands the area of interest into domains which are presently ruled by the building and construction (B&C) sector. The need for a good co-operation and a co-ordination of responsibilities is obvious. The full market penetration of solar combisystems may even depend more on a successful development of solar architecture than on prices and technology.

Norway is a very small solar market of obvious reasons. Interesting is though that this market requested combined solar systems already from the first days, in contrast to other markets where SDHW-systems are or have been dominating. It is interesting to notice that in the recently published book, "Built for a new Century" [1] edited by the Norwegian Architects Association, 10 out of 50 examples of future buildings have integrated solar combisystems. This positive attitude from architects to solar energy is a challenging invitation to expand the "solar society".

2. Physical aspects of roof integration

A building is a complex system exposed to various external and internal loads. The primary task of the roof is to protect the building inside from impacts due to various weather conditions. Conventional on-roof mounted collectors of SDHW systems are small, external installations with little influence on the physical performance of the building. However larger and building integrated collector fields - required for solar space heating - will significantly change the physical performance of the roof or façade.

Figure 1 illustrates the cross sections of two roof constructions which are common in the north of Europe. Figure (1a) shows a so-called "cold roof" where the room under the roof cover is insulated from the interior of the building. The temperature inside a "cold roof" follows closely the daily and seasonal variations of the ambient temperature.

Figure (1b) shows the structure of a warm roof. Due to the increasing specific costs of the living area, the "warm roof" becomes more common, as it offers a higher degree of utilisation of the building volume.

1a) "cold roof"

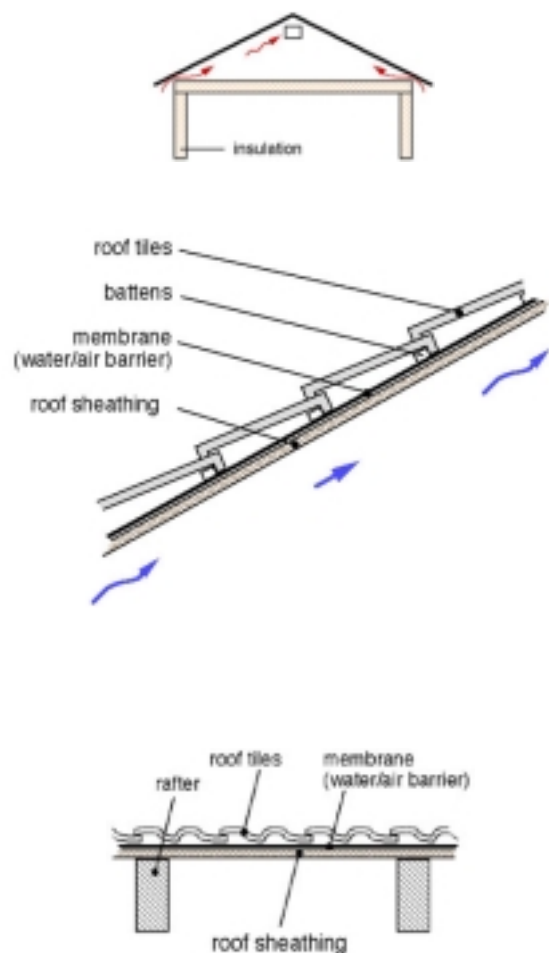

1b) "warm roof"

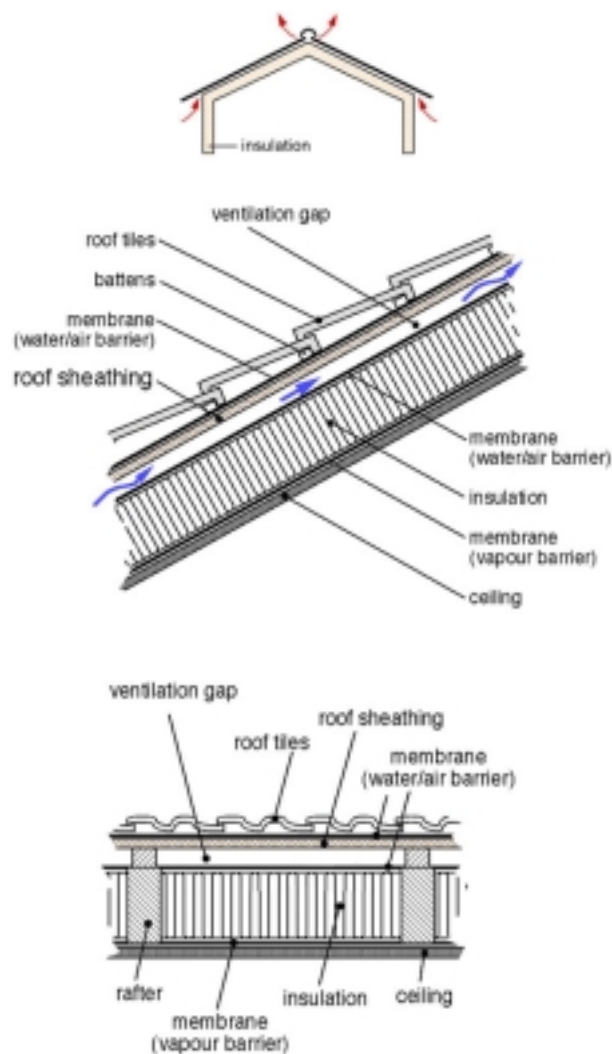

Fig. 1. Cross section of a typical roof construction in the north of Europe: (a) "cold roof" and (b) "warm roof"

While the "cold roof" is a rather simple construction, the warm roof is a complex structure which aims to balance the physical processes related to the variations in temperature and humidity during the cold season of the year.

- The diffusion tight membrane toward the interior of the building prohibits that warm and humid air from the living area penetrates the insulation layer. Further the support of a slight indoor-outdoor under-pressure avoids the transport of warm humid air in this direction.
- The ventilation gap above the insulation continuously transports ambient air through the roof construction in order to stabilise the temperature of the roof sheathing to the ambient temperature. This stabilisation is mandatory in order to minimise condensation and to avoid that ice is built up under the roof sheathing. It also prevents melting of snow on the roof which may lead to leaks caused by standing water on the roof.
- The location of the ventilation gap in the roof structure is related to local climatic conditions and the position of the dew point in the roof construction. In warmer climates this gap is moved directly under the roof tiles.

Figure 2 shows the integration of solar collectors into the roof structures of Fig. 1. The demands to collectors placed on a cold roof (Fig. 2a) are to provide the necessary strength and protection against the various weather influences. As collectors are normally lighter than standard roofing materials, an integrated collector roof will not cause extra load to the bearing construction. In practice the roof tiles are substituted with a collector sandwich consisting of a transparent cover, absorber and insulation.

Replacing the tiles in a "warm roof" with solar collectors (Fig. 2b) perturbs the thermal balance discussed above. Most of the time the solar collector will have a higher average temperature than the tiles. This temperature shift moves the dew point. Hence the need for ventilation between the roof sheathing and the roof insulation becomes less significant [2]. This change in the thermal properties can, in many cases, justify simplifications of the roof construction and consequently lead to cost reductions.

Another aspect concerns snow accumulated on the roof: Usually the solar collector will not accumulate snow over longer periods, except during certain weather conditions. Consequently the need for ventilation of the sub-roof in order to avoid melting of snow and water trapping is reduced.

The conclusion which can be drawn is that a "warm roof" completely covered with solar collectors might be designed without the extra ventilation gap shown in Fig. 1b. We would like to suggest that this design is thoroughly investigated by means of pilot projects under different climatic conditions.

2a) "cold roof"



2b) "warm roof"

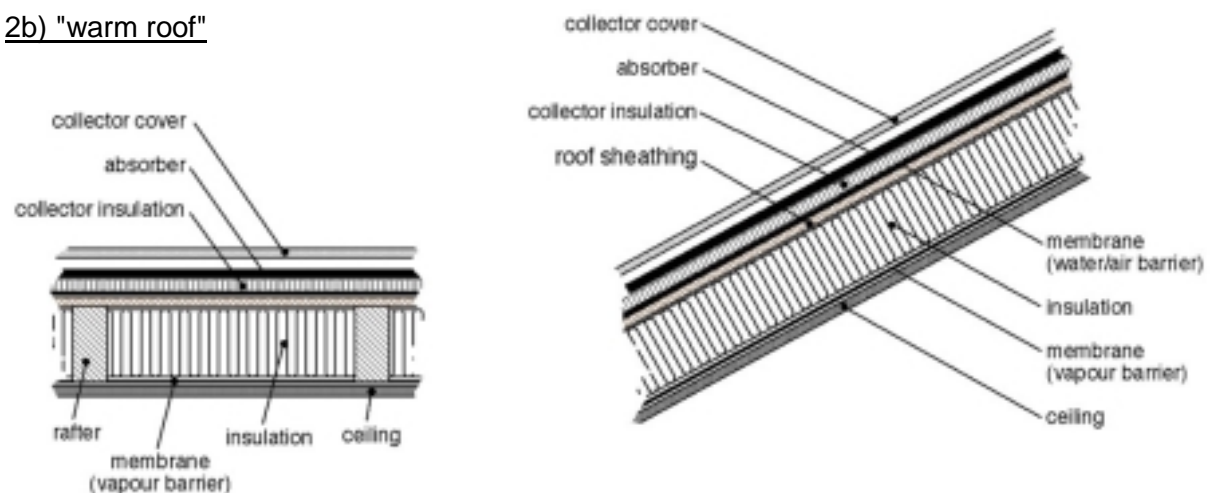

Fig. 2. Integrated solar collectors on a cold and warm roof construction; the need for a ventilation gap becomes less significant.

Figure 3 illustrates the situation where a integrated collector field is located on the upper part of the roof and a conventional roof on the space below the collectors. Snow will easier glide down the collector roof because of the temperature and the surface roughness. The accu-

mulation of snow and ice on the tiles below the collector field will trap and collect water under certain thermal conditions. The transitions between different roof covers represent weak parts in the roof construction with stronger risk for leaks. Our experience suggests that this design should be avoided. Generally the best results will be obtained when the architect designs the building in such a way that a complete roof or natural divisions can be dedicated to solar collectors. Any transition between different roof covers requires additional measures for rain water transport, for ventilation and against accumulation of snow, and causes usually additional costs.



Fig. 3 Snow accumulation on a partly covered collector roof

3. Mounting of an integrated collector roof

Figure 4 outlines four rather common processes of mounting an integrated collector roof:

- collector with on-roof assembly
- collector as roof cover module
- collector in metal casing ("on-roof collector")
- collector as factory prepared roof unit

The collector integration with on-roof assembly (Fig. 4a) is partly motivated from solar activities in early days and the "do-it-yourself" market. The mounting of the collector's framing with insulation, the absorber units, the collector cover and the coupling between all sections is to a large extent carried out on the roof. This solution offers a large degree of freedom to adjust to given architectural frames. However it requires that installers with specific technical competence are over longer periods bound in the mounting process at the site, increasing the installation costs. Another draw-back is related to the weather and seasonal dependency of any work on the building skin, and the fact that the installers need to operate at a place which might not correspond to their normal working days' environment ("plumbers on the roof").

In order to limit the on-roof assembly, solutions as shown in (4b), (4c) and (4d) were developed in which the on-roof mounting mainly requires competence within building construction. In example (4b) the collector insulation with wooden framing is part of the roof construction. Here a factory prepared roofing module includes the absorber and the collector cover.

Common are also roofing modules including the cover, absorber and insulation (wooden casing). Certain collectors offer the flexibility for on-roof and roof-integrated installation (4c), normally equipped with metal casing.

An elegant solution is the example in Figure (4d) where the collectors are delivered as factory prepared roof units, similar to elements of pre-fabricated houses. The production of such

a roof integrated collector incorporates a rather complex industrial process and the flexibility in dimensions might be limited.



(a) on-roof assembly



(b) collector as roof cover module



(c) collector module with casing



(d) collector as factory prepared roof unit

Fig. 4 Different types of roof integrated solar collectors.

Traditionally solar systems are installed by the HVAC branch. This is natural for SDHW systems where the solar elements are a typical "tail equipment" to the conventional heating installations. Still the "plumber on the roof" syndrome has represented a barrier for the distribution of solar systems in the market.

The installation of large collector areas, and in particular the roof integration, motivate a re-consideration of the question which professional branch should install the solar roof. By regulations pressurised water systems demand today certified installers, un-pressurised systems do not. A natural and practical change could be to transfer the responsibility for the installation of solar roofs to the roofing companies provided that the design of the collector is adjusted to their demands. The interface between the plumbers and the roofing company could then be at a convenient place between the roof and the boiler room. A local separation of the installation tasks will clearly define the area of responsibility and the period in which each branch has to be present at the building site.

4. Project planning and boiler room

An integrated solar collector field which takes a substantial part of the roof, represents an architectural element which should be incorporated in the overall building design at an early planning stage. Not only the aesthetic aspects, but also technical or practical issues make good planning mandatory in order to obtain good results.

It is not seldom that conflicts occur between the location of chimneys, roof windows, ventilation gaps and solar collectors, and compromises may stand as monuments over poor planning. Usually there is sufficient space available and a good result is a matter of good planning.

A boiler room is needed for housing the installations related to the solar system and additional components for the heating of space and domestic hot water. After 30 years with direct electric heating in Norway, the boiler room has been almost forgotten by architects and building designers. The rapid change in the Norwegian market from direct electric heating to indirect heating systems has revealed the lack of understanding in providing space for suitable technical installations.

The feasibility of a solar combisystem depends on the heat storage. In Norway typical storage volumes are 1 m³ pr. 100 m² floor area, which means in the range of 3 - 4 m³ storage volume for large single-family houses. Normally the space for the boiler room requires approx. 2% of the heated floor area. Both from a functional and economical point of view, the boiler room should be placed in a shortest possible distance to the solar collector, and the path for the pipes between these elements should be well planned. One should also pay attention to the needs of transporting large units into the boiler room. Standard door dimensions, narrow corridors and stair halls limit where and when during the building process the boiler room equipment can be placed. Taking the high building costs in consideration, the boiler room should occupy a low value area of the building. Figure 5 shows examples of how a boiler room could be placed in different building designs with a minimum of inconvenience.

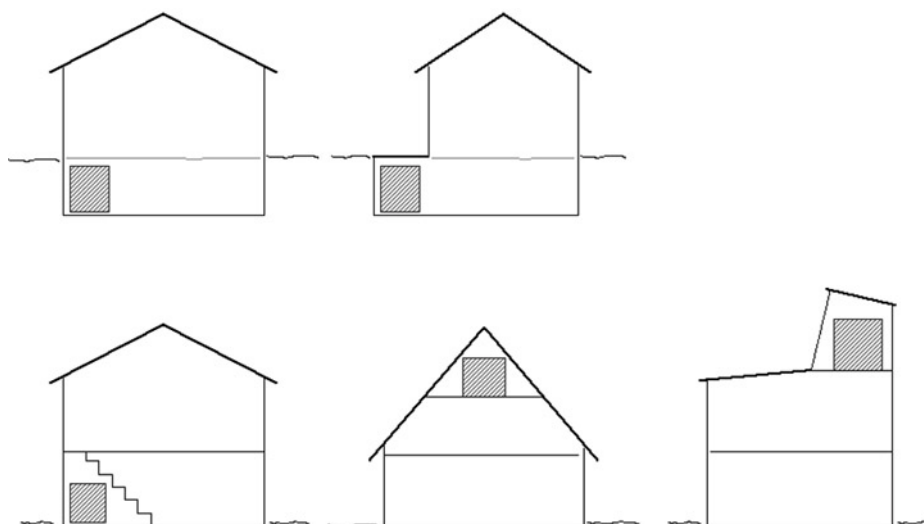

Fig. 5. Possible locations for a boiler room in buildings with and without basement

Our experience is gained with drainback systems, which request additional demands to the position of the heat store and the paths of the piping. Drainback systems have the advantage that water without antifreeze fluid can be used as heat carrier. This advantage increases with the size of the collector area. However the drainback function requires that water can move back to the store by the force of gravity. The pipes have to be mounted with care in order to permit exchange of air and water during the start-up and the drainback phase.

Finally one should keep in mind that architects, who are normally the first actors involved in the planning process, start the planning from approaching a client's requirements. This might be rather to reduce the total purchased energy than to use a certain type of technology [4]. The challenge is to inspire architects and building consultants for the issues of importance in the planning of integrated combisystems. There are many examples of elegant solutions where this interest has been evident, but unfortunately also numerous negative experiences caused by ignorance from the architects, consultants or entrepreneurs.

5. Aesthetic aspects

The roof is the part of the building with numerous possibilities for integration of solar collectors. Roof integrated collectors have to fulfil the various demands of a standard roof and have to fit to the overall concept of the building design. Maybe except for the solar enthusiasts the aesthetics of a building is one of the most important aspects when solar collectors are integrated into the building skin. The collectors have often been considered as separate elements placed on the building and disregarding the architecture of the building itself. For architects the most common reasons for unacceptable roof top solar energy systems are the disharmony with the geometry of the roof or the placement of the components without any context to the roof scale that lead to a fragmentation of homogenous spaces [3], [4].

The integration of collectors should be coherent with the design of the roof and façade of a building. The first trends towards building integration show that "integration" has been considered synonymous with "invisibility". The aim was to maximise integration and to hide the fact that solar systems were different from other building elements. This praxis has changed and architects started to use solar systems in order to enhance the aesthetic appeal of a building by providing variation or contrast [5].

Solar collectors enlarge the spectrum of materials and components that may be used in building construction. However architects express a certain lack of "solar design". This may, among others, be related to that the design and planning of buildings (architect) is done separately from research and development of components (engineer) [3].

Roofs play an important role in the appearance of towns and villages. The roof shapes are influenced by regional differences, by climate and used materials. For certain forms it seems to be easier or more suitable to integrate large collector fields, considering the fact that collectors are usually rectangular shaped. More coherent integration possibilities are e.g. given for 'single pitched' roofs and 'saddle back roofs' than for hipped or mansard roofs. The latter roof types provide less rectangular space for the components. The placement and design of windows in a collector roof is another important aspect.

One way of achieving integration is to cover a complete roof surface with collectors. In many cases it may also be the most cost effective one. Figure 6 shows a Norwegian example for such a collector roof. The coloured brochure [6] includes further examples of this type (e.g. p. 4 - Denmark; p. 10 - Austria).

The uniformity of such a solar roof can be "broken" by architectural means as building extensions, winter gardens (Fig. 7) and by using natural divisions in a roof or planes of different level (e.g. ref. [6]: p. 4 - Austria, p.17 - Austria).

There are many cases which aim to exhibit that a large collector roof is not restricted to the flat rectangular form and can contribute significantly to the building design. The asymmetric elements in the front façade of the single-family house shown in Fig. 8 are repeated in the solar roof. Another example is the apartment building in the suburb Plan-les-Ouates, west of Geneva, Switzerland, where a solar roof was designed with an elegant curvature [5].

Limited space is available to discuss the various aesthetic aspects in terms of illustrations. Further a "good design" is among others a question of personal taste or influence by the line of architecture. We might leave the competent judgement about successful designs to architects.



Fig. 6. Ranten Mountain Resort, Nesbyen, Norway (solar combisystem for DHW-, space- and swimming pool heating; collector area: 200 m², storage volume: 4 m³, pool volume: 90 m³)



Fig. 7 "April house" in Tønsberg, Norway (solar combisystem; collector area: 20 m², storage volume: 1 m³)



Fig. 8 Single-family house, Oslo, (solar combisystem; collector area: 30 m², storage volume: 3 m³)



References

- [1] Butters, C., Østmo, F., Bygg for en Ny Tid, editor: NABU - NAL, Oslo, 2000
- [2] Norwegain Building and Research Institute, Vannbaserte solfangere - Funksjon og energiutbytte, Byggforskserien: Byggforskdetiljer A 552.455, 1991.
- [3] Krippner, R., Herzog, T., Architectural aspects of solar techniques - Studies on the integration of solar energy systems. Proceedings EuroSun 2000, 3rd ISES-Europe Solar Congress. 19.-22-06.2000, Copenhagen, Denmark.
- [4] Herzog, T., Krippner, R., Synoptic description of decisive subsystems of the building skin, Proceedings Building a New Century, 5th European Conference Solar Energy in Architecture and Urban Planning, 27.05.1998, Bonn, Germany.
- [5] Hestnes, A.G., Building integration of solar energy systems, Solar Energy, vol. 67, Nos. 4-6., pp. 181-187, 2000.
- [6] J.-M.Suter et al., Solar Combisystems - Overview 2000, IEA SHC-Task 26, 2000.

FACADE INTEGRATION – A NEW AND PROMISING OPORTUNITY FOR THERMAL SOLAR COLLECTORS

Werner Weiss, Irene Stadler
 AEE – Arbeitsgemeinschaft Erneuerbare Energie
 Feldgasse 19, 8200 Gleisdorf, Austria
 Tel.: +43 3112 5886 17
 Fax.: +43 3112 5886 18
 E-mail: w.weiss@aee.at

1 Abstract

In the main solar thermal systems are used to prepare hot water in small-scale plants. When it comes to applications in the field of solar space heating, large-scale plants in urban building projects, hotels and solar local heating networks, there are not always sufficient suitable and oriented roof areas available for the installation of solar collectors. When installing these on existing roofs or joining them to flat roofs, the plants often form a foreign body since they are not an integral part of the architecture. For this reason solar plants are still rejected by some architects and town planners. For a wide market penetration it is, therefore, necessary to develop collector systems with which it is possible to integrate the collectors in façades.

As the development of façade systems for photovoltaic modules has shown, these open up a large and new market segment.

Within the framework of a project financed by the Austrian ministry for traffic, innovation and technology, system-, structural- as well as building physical basis theories will be elaborated, which will serve as a basis for constructional and aesthetically attractive solutions for the production of façade integrated solar collectors without thermal separation. The recyclability of the materials used and resource efficiency play a central role when it comes to the development of constructional solutions.

The results of this project are used by the two solar engineering companies participating in this project as a basis for the production of test façades and subsequently for the transfer to manufacturing and series production

2 Direct Façade Integration

In this context a collector element directly integrated in the façade is understood by the façade-integrated solar collector in which heat insulation is a component both of the building as well as of the collector. There is no thermal separation between both of these in the form of rear ventilation.

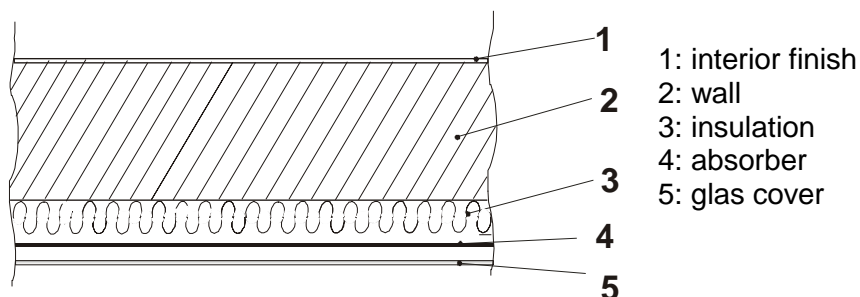

Fig. 1: Integrated collector without rear ventilation

The collector which comprises a fluid-cooling absorber, a glass disk, glass bearer profiles, sealings and covering sheet metals, therefore, assumes different functions:

- function as a thermal flat collector
- improvement in heat insulation of the building respectively the attainment of passive gains
- protection against atmospheric conditions
- a structural design element for the façade

In accordance with this the advantages of façade integrated collectors are:

- cost savings as a result of joint use of building components
- replacement of the conventional façade
- suitable both for new buildings and for the renovation of old buildings

Therefore façade collectors are:

1. Integral part of the architecture
2. Energy Converter

3 Architectural Aspects

Façade collectors can be used as an element for design for buildings. By varying the surface grid dimensions, the kind and colour of the cover strip and the colour of the absorber the look of the façade can be changed. To determine the demand from the architects a survey among architects has been carried out (see Fig. 2, Fig. 3 and Fig. 4).

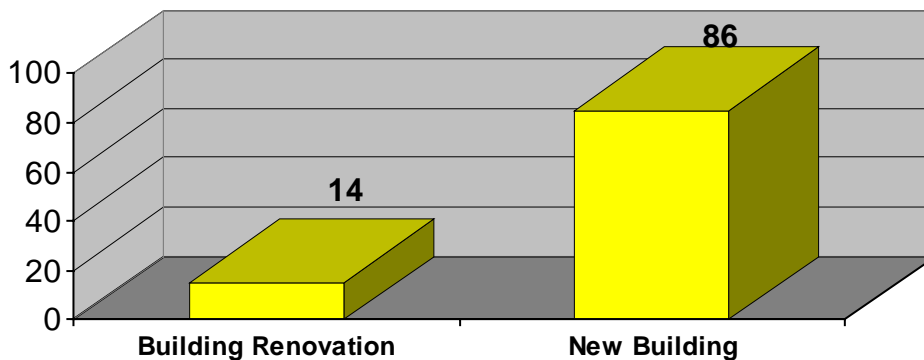

Fig. 2: Primary fields of application of façade collectors, survey amongst architects (52 answers)

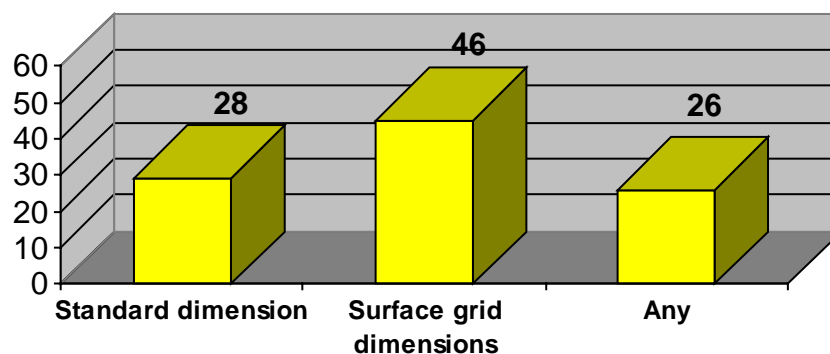

Fig. 3: Preferred dimensions, only 29% of the questioned Architects are content with standard dimensions.

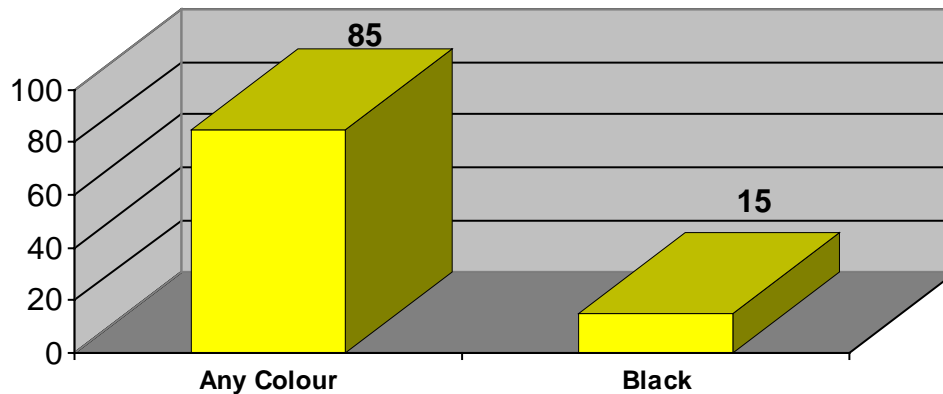

Fig. 4: Colour of collectors, survey amongst architects. 85% of the architects would prefer different colours besides black (taking a lower yield into account)

Consequences of the architectural integration:

- Standard collector sizes are not or only very rarely possible
- The architect determines the surface grid of the façade !!!
- In most cases the surface grid does not correspond to the size of the absorber
- Co-operation is necessary between the architect and the designer at a very early stage
- There is a need of façade design know-how
- The collector is often „only“ part of the façade
- Connection to other parts of the façade (with windows, doors, roof...)
- The façade constructor has to also build the „rest“ of the façade

Coating of absorbers:

- Solar varnish
- Selective layers
 - Coil coating
 - Maxorb layer

Critical items

- The fixing of the glass cover (cover strip)
- The fixing of the absorber in the collector
- Thermal bridges
- The ventilation of the collector (“air tightness”)
- The collector’s hydraulic scheme
- The adaption of the system as a whole

Demands from Façade Collectors

- Flexible means of production
 - The co-ordination of interfaces
 - close contact to architects
 - close contact to plumbers and HVAC engineers
 - Know-how in the field of solar engineering
 - hydraulic schemes
 - systems engineering
 - Know-how in the field of façade construction
 - building physics
 - a knowledge of standards and regulations in the field of façade construction
-

Transparencies:**Collector acts as sound protection**

Picture: Adsy Bernard

High level of Pre-manufacturing

The architecture determines the surface grid



Shade in summertime



4 References

/1/ Diem, Paul, Bauphysik im Zusammenhang, 2. Auflage 1996, Bauverlag

/2/ Rockendorf, Janßen: Façade Integrated Solar Collectors, Institut für Solarenergieforschung GmbH, Hameln

/3/ Stadler Irene, AEE, Façade Integrated Solar Thermal Collectors, Congress Solar Space Heating in Graz, Austria , 2001